

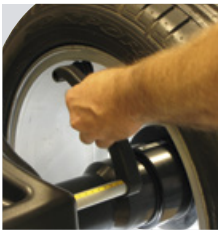

AUTOMATIC DISTANCE + DIAMETER MEASUREMENT



RIM RUN-OUT



Misurazione eccentricità cerchio con il calibro distanza.
Rim run-out measurement with internal data gauge.
 Felgenunrunheitsvermessung mit Abstandtaster.
Mesure d'excentricité jante par la pige.
 Medición alabeo llanta desde el calibre.

QUICK PROGRAM SELECTION



ALUS
 ALUS1
 ALUS2
 STAT
 STAT1
 STAT2
 DYNAMIC

Sono selezionabili 7 programmi semplicemente con l'utilizzo del tastatore automatico.
7 programs can be selected by simply using automatic internal data gauge.
 7 Programme einfach mit dem automatischen Innentaster auswählbar.
7 programmes peuvent être sélectionnés en utilisant simplement la tige interne automatique.
 7 programas pueden ser seleccionados por el simple uso de el palpador interno automático.

6 Models		ERP 255WS	ER 255WS	ERP 255RS	ER 255RS	ER 255R	ER 255R
P=PNEUMATIC LOCKING		✓	-	✓	-	✓	-
MANUAL LOCKING		-	✓	-	✓	-	✓
S=LASER BLADE + 2 LED LIGHT		✓	✓	✓	✓	€ GAR311	€ GAR311
W=SONAR WIDTH		✓	✓	-	-	€ GAR353	€ GAR353
WHEEL WIDTH GAUGE		-	-	✓	✓	€ GAR266	€ GAR266

✓ STANDARD € OPTIONS

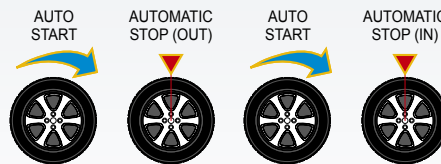

ER255 SERIES



Risparmio e rapidità.
 La prima videata indica le 2 opzioni di equilibratura:
 - tramite 2 pesi
 - mettendo un solo peso (Ecoweight = risparmio).
 La seconda videata indica gli squilibri residuali utilizzando un solo peso.

*Speed and profit. The first image shows 2 balancing options:
 - with 2 weights
 - with only 1 weight (Ecoweight = profit).
 The second page shows residual unbalance using 1 weight only.*

Schnell und sparsam.
 Das erste Videobild zeigt die zwei möglichen Wuchtvorgänge an:
 - mittels zweier Gewichten
 - mittels eines Gewichtes (Ecoweight = Gewichte sparen).

Das zweite Videobild zeigt die Restunwucht bei Benutzung eines Wuchtgewichtes an.

*Rapidité et profit. La 1ère image indique 2 options d'équilibrage:
 - avec 2 masses
 - avec 1 seule masse (Ecoweight = profit).
 La 2ème image indique le balourd résiduel en utilisant 1 seule masse.*

Ahorro y rapidez. La primera pantalla indica 2 opciones de equilibrado:
 - A través de 2 plomos
 - Colocando 1 solo plomo (Ecoweight = ahorro)
 La segunda pantalla indica los desequilibrios residuos utilizando un sólo plomo.

Equilibratrici computerizzate

(IT)

Wheel balancers with microprocessor

(EN)

Elektronische mikroprozessor-gesteuerte Radauswuchtmaschinen

(DE)

Equilibradores a microprocesseur

(FR)

Equilibradoras con microprocesador

(ES)



COMPANY WITH
QUALITY SYSTEM
CERTIFIED BY DNV GL
= ISO 9001 =

RS models include

1 + 2 + 3

WS models include

2 + 3 + 4



ER255RS

1-WHEEL WIDTH GAUGE

2-DOUBLE LED LIGHT

3-LASER BLADE



ER255WS

4-WIDTH SONAR

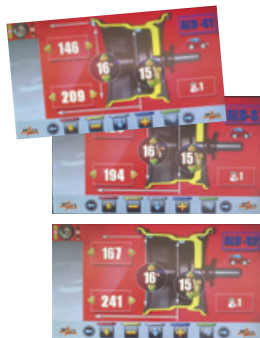

ALU-S



STATIC



SPLIT



DYN

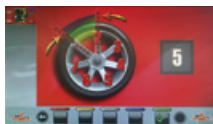

SPOKE



AIR-LOCK →
ERP255R
ERP255RS
ERP255WS

Standard

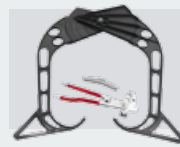

GAR 111 (Ø 44-112 mm)



GAR 101

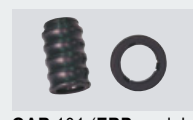

GAR 101 (ERP models)

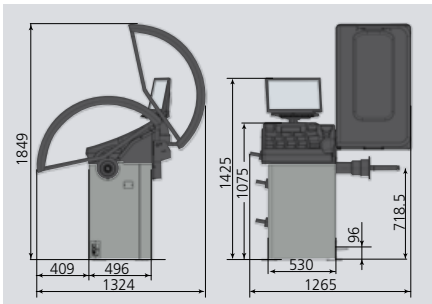

Dati tecnici	Technical Data	Technische Daten	Techniques	Datos Técnico	
Diametro cerchio	Rim diameter	Felgendurchmesser	Diamètre de la jante	Diámetro de la llanta	10"±30" 10"±26" automatic
Larghezza cerchio	Rim width	Felgenbreite	Largeur de la jante	Anchura de la llanta	1.5" - 22"
Peso max ruota	Max wheel weight	Max. Radgewicht	Poids maxi de la roue	Peso máximo de la rueda	70 kg
Precisione equilibratura	Read-out accuracy	Max. Auswuchtgenauigkeit	Précision d'équilibrage	Precisión de equilibrado	1 g
Tempo di ciclo	Cycle time	Messzeit	Durée du cycle	Tiempo de medida	6 s.
Velocità di rotazione (giri/min)	Rotation speed (rpm)	Drehgeschwindigkeit (U/min.)	Vitesse de rotation tours/min	Velocidad de rotación vueltas/min.	< 100
Alimentazione	Power supply	Spannung	Alimentation	Motor monofásico	110-230V / 50-60/1ph

SPACE s.r.l. a s.u.

Via Sangano, 48
10090 Trana - Torino - ITALY
tel. +39-011-934.40.300
fax +39-011-933.88.64
e-mail: info@spacetest.com
www.spacetest.com

Le caratteristiche tecniche e gli allestimenti presentati in questo prospetto possono subire variazioni. Le immagini riprodotte non sono vincolanti.
Technical data and composition presented in this catalogue may vary. Pictures reproduced are only indicative.

Die techn. Daten und die Ausrüstungen, die in diesem Prospekt enthalten sind, können Änderungen erfahren. Deshalb sind die Abbildungen unverbindlich.
Les caractéristiques techniques et les compositions présentées dans ce prospectus peuvent subir des variations. Les images reproduites n'ont qu'une valeur indicative.

Las características técnicas y las composiciones ilustradas en este folleto pueden sufrir variaciones. Las imágenes propuestas son solamente indicativas.

CE DTJ02U (02)