

# CUPLA

GENERAL CATALOG



## CUPLA enable flexible and fast connections in various fluid lines.

Nitto Kohki's unique technologies and dedicated research have been proven by numerous patents, which led to the development of 25,000 different CUPLA variations.



Nitto Kohki's quick connect couplings, "CUPLA" enable speedy connections/disconnections of various pipings, such as air, water, oil and gas.

They are active in various industrial fields, thanks to the experience in development of 25,000 different variations. Wide varieties of body materials such as steel, brass, aluminum, stainless steel and plastic are available to match every customer's needs.

- Applications diversify from general household to high-tech industries such as in oceanic and space development.
- Numerous sizes are available for various needs.
- Wide varieties of body materials such as steel, brass, plastic, aluminum or stainless steel are available.

A profusion of patented technology crystallized in global users recognition of high quality and high performance.

### ISO 9001 and 14001 Certification Award

"CUPLA" quick connect couplings are produced as the crystallization of high-grade know-how nurtured in the fields of fluid engineering and materials engineering, and top level precision machining technology. Having assessed Nitto Kohki consistent quality assurance and control system ranging from design and development through procurement of material, manufacture, assembly, and shipping, the Japan Quality Assurance Foundation, authority for inspection and registration, awarded us "ISO 9001", international standard for quality management systems, and "ISO 14001", international standard for environment management systems intended to perform global environment preservation and pollution control. High reliability built on unparalleled "high quality" and accumulated history of "productivity" for stable supply. CUPLA is receiving overwhelming support from many users spread all over the world as the top brand for fluid energy transmission and control.



ISO 14001  
JQA-EM4057  
H.Q./R&D Lab



ISO 9001  
JQA-2025  
H.Q./R&D Lab

# CUPLA



# CUPLA

Quick Connect Couplings

## For easy replacements

Replacements of pneumatic / hydraulic tools, pneumatic / hydraulic cylinders, mold attachments, etc.

## For temporary installation in test line

Vacuum tests, pressure durability tests, leakage tests, running tests, etc.

## For filling

For filling up various industrial gases, including inert gases, nitrogen, LPG, carbon dioxide, oxygen, fuel gas, etc.

## For maintenance services

For computer cooling system, hydraulic cylinders in die-casting machines.

## For transfer

For transfer of solid items through pipes such as screws and nuts as well as for electric power cable lines.

## As joints

Applications other than fluid transfer covering connections for holding works while anchored or carried around.

## Nitto Kohki's Official YouTube channel

Watch our products in action. We have various products from Quick Connect Couplings "CUPLA" to Power and Machine Tools, "delvo" Electric Screwdrivers, Linear-motor-driven Free Piston Pumps and also Door Closers.



[www.youtube.com/c/NittoKohkiGLOBAL](http://www.youtube.com/c/NittoKohkiGLOBAL)

## ⚠ Beware of imitations

Recently on the market, there have appeared similar products that invite misidentification or confusion with Nitto Kohki couplings, or such products that claim to have compatible mating parts. Nitto Kohki cannot accept responsibility for any accident that may result by mixed use with a coupling of another brand that seems connectable to a Nitto Kohki coupling. Nitto Kohki CUPLA are produced with their own unique tolerances and precision under strict quality control, and are not interchangeable with other couplings that are not under such tolerances. Therefore, connection to other brand of coupling may end up with abrupt breakdown or personal injury. Please be sure to check for our marks below, which are always inscribed on Nitto Kohki CUPLA products, when you order and purchase.



## CONTENTS

Environmental activities / Contents	1 to 2
New product (CUBE CUPLA)	3
Nitto Kohki's environmentally-friendly Manufacturing	4
Select an Appropriate CUPLA for the Job	5
Glossary	6
Guide for Selecting "NITTO KOHKI" Standard CUPLA	7 to 16
Semi-standard CUPLA Series and CUPLA Accessories	17
Special Made-to-Order CUPLA	18
HI CUPLA Series Interchangeability	19

## Standard CUPLA Series

MICRO CUPLA	21	MOLD CUPLA	69
MICRO CUPLA with Tube Fitter	21	MOLD CUPLA High Flow Type	71
MICRO CUPLA Stainless Steel	21	FLOW METER	72
SMALL CUPLA	25	LEVER LOCK CUPLA Metal Body	73
COMPACT CUPLA	27	LEVER LOCK CUPLA Plastic Body	73
CUBE CUPLA <b>NEW</b>	29	TSP CUPLA	77
SUPER CUPLA	33	TSP CUPLA with Ball Valve	79
SUPER CUPLA with Tube Fitter	33	SP CUPLA Type A	81
HI CUPLA	35	HOT WATER CUPLA HW Type	83
HI CUPLA BL	37	ZEROSPILL CUPLA	85
HI CUPLA 200	39	HSP CUPLA	87
HI CUPLA 200 with Tube Fitter	39	HYPER HSP CUPLA	89
HI CUPLA for Connection to Braided Hoses	41	210 CUPLA	91
NUT CUPLA	41	HSU CUPLA	93
NUT CUPLA 200	41	S210 CUPLA	95
ROTARY NUT CUPLA	41	280 CUPLA	97
LOCK CUPLA 200	43	350 CUPLA	99
HI CUPLA Two Way Type	44	FLAT FACE CUPLA F35	101
FULL-BLOW CUPLA	45	FLAT FACE CUPLA FF	103
PURGE HI CUPLA PVR Type	47	450B CUPLA	105
PURGE HI CUPLA	49	700R CUPLA	106
PURGE LINE CUPLA	50	MULTI CUPLA MAM Type	107
ROTARY LINE CUPLA RT Type	51	MULTI CUPLA MAM-B Type	109
ROTARY LINE CUPLA RE Type	51	MULTI CUPLA MAM-A Type	113
LINE CUPLA 200T Type	53	MULTI CUPLA MAS/MAT Type	117
LINE CUPLA 200L Type	53	MULTI CUPLA MALC-01 Type	119
LINE CUPLA 200S Type	53	MULTI CUPLA MALC-SP Type	121
ROTARY FULL-BLOW LINE CUPLA	55	MULTI CUPLA MALC-HSP Type	125
HI CUPLA ACE	57	SEMICON CUPLA SP Type	129
ROTARY PLUG	59	SEMICON CUPLA SCS Type	130
TWIST PLUG	60	SEMICON CUPLA SCY Type	131
PURGE PLUG	61	SEMICON CUPLA SCT Type	132
ANTI-VIBRATION PLUG HOSE	62	SEMICON CUPLA SCAL Type	133
DUSTER CUPLA	63	SEMICON CUPLA SCF Type	134
NK CUPLA HOSE	64	SP-V CUPLA	135
NK CUPLA COIL HOSE	64	PCV PIPE CUPLA	137
MINI CUPLA	65	PAINT CUPLA	139
MINI CUPLA SUPER	67	HYGIENIC CUPLA	141

## Semi-Standard CUPLA Series

CUPLA with Single Lock	143	HIGH FLOW CUPLA BI Type	146
CUPLA with Safety Lock	143	SP CUPLA Type A PV Type <b>NEW</b>	147
Two-way Shut-off Type Small Size CUPLA	144	PLASTIC CUPLA BC Type	148
TSP-HP CUPLA for High Pressure	144	PLASTIC CUPLA BCC Type	148
HIGH FLOW CUPLA	145		

## Accessories

**NEW** 149 to 154

Seal Material Selection Table for Reference	155 to 157
Body Material Selection Table	158
Unit Conversion Tables	159
CUPLA Inquiry Form	160
Taper Pipe Threads	162
Production Facilities That Assure Our Product Quality	163
From Development to Production, Management and Marketing of "CUPLA"	164
Nitto Kohki's Laborsaving Products	165
Safety Guide	166 to 172
Maintenance of CUPLA	172

New product

# Newly designed in colorful 5 colors.

Quick connect couplings for air / water piping

## CUBE CUPLA

- An effective outer appearance.
- Prevent piping mistakes by color indication.

Select from All five colors

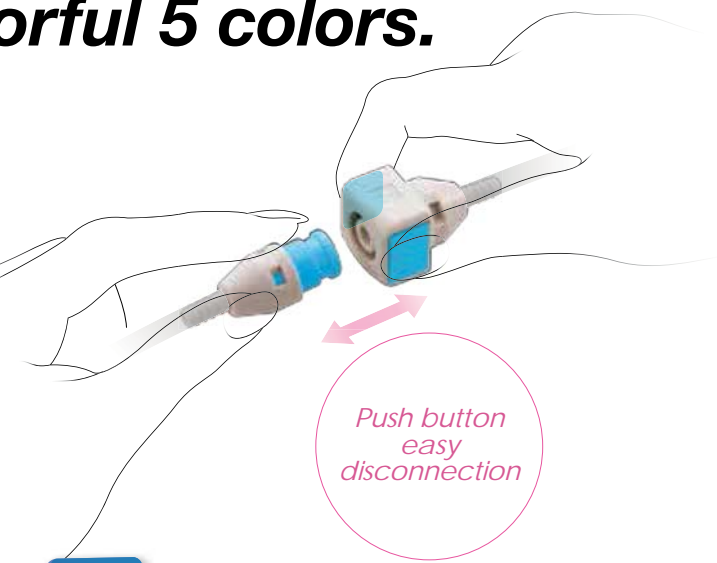

**5 colors** To prevent misconnection of piping

Pipings that are difficult to identify **Connect without hesitation at a glance**

It is also possible to check colors after connection



- Small size**
  - Light weight**
  - Push-to-connect operation**
  - Push button easy disconnection**
- L type plug series added**
- 
- For tube connection

### Application example

Air piping of muscle compression machines for training

Ink piping and cooling water piping of commercial inkjet printers

For air piping of office automation equipment, measuring and analyzing fields, etc.

The above application is an example only. When adopting, please consult us separately.

See page 29 to 32 for details.



# Nitto Kohki's environmentally-friendly Manufacturing

The coexistence of mankind and nature. Each company is now asked for a global level environmental conservation and improvement as important themes. As a part of the environmental improvement activities, we are offering various products such as "couplings", "machines and tools", "screwdrivers", "air compressors and vacuum pumps", and "door closers" as green procurement products.

## "CUPLA" active in the widespread field of the manufacturing industry.



## Coupling for fuel cell vehicles.

### HHV CUPLA

CUPLA for fueling high pressure hydrogen

Fuel cell vehicles are one of the remarkable environmental conservation solutions. In order to respond quickly to environmental problems, Nitto Kohki has developed the first coupler in Japan to supply and fill its fuel source, high-pressure pure hydrogen.

**HHV CUPLA**  
70 MPa

# Nitto Kohki's environmentally-friendly Manufacturing

## Green Procurement

Nitto Kohki has made every effort in developing "Environmental Improvement Plans" through the implementation of ISO14001, to execute environmentally conscious business activities on a company-wide basis. As a part of our ongoing commitment to the environment, we are also committed to reduce and/or exclude restricted chemical substances from our products as designated by RoHS directives, laws and regulations of chemical substances.

All couplings except for the following products have been switched to green procurement compliant products.

- LEVER LOCK CUPLA
  - All CUPLA products with Tube Fitter
  - CUPLA CONNECTING JIG
  - PRESSURE GAUGE
- } Non compliant

Please visit our website for applicable products.

[www.nitto-kohki.co.jp/e/](http://www.nitto-kohki.co.jp/e/)



## CUPLA

### Products using regulated substances and the countermeasures taken

Products (Standard CUPLA)	Major countermeasures
Products using brass material	Low cadmium contained material used (RoHS directive compliant material)
Zinc chrome plated couplings	Hexavalent chromium-free plated (Such as nickel plated)

Note: Color of plating

The color of the zinc chrome plating is yellow, while nickel plating is silver. Some products may look different in appearance when changed.

# Select an Appropriate CUPLA for the Job

Nitto Kohki has the wide range of CUPLA products covering almost every application and feature you need. In order to select an appropriate CUPLA for your job, you need to realize the following specifications.

## Specifications to Be Checked When Selecting CUPLA

<b>Fluid and the Temperature</b>	Select a CUPLA with body and seal materials that suit the fluid and its temperature.	There are different body and seal materials to suit different fluids. For example, we recommend steel HI CUPLA for air, and brass or stainless steel for water. Please refer to Body Material Selection Table and Seal Material Selection Table at the end of this catalog for details about the correspondence between fluids and materials.
<b>Fluid Pressure</b>	Select a CUPLA suitable for the actual Maximum fluid pressure.	Fluid pressure is also a key to CUPLA selection. Each series of hydraulic CUPLA have different structures to cope with each pressure resistance ranges up to 68.6 MPa (700 kgf/cm <sup>2</sup> ).
<b>Automatic Shut-off Valve</b>	Select a CUPLA with a valve structure that suits the piping application.	Valve combinations are two-way shut-off, one-way shut-off, or straight through types. Choose carefully. Unless it is a two-way shut-off type, the internal fluid will flow out from the CUPLA without valve when it is disconnected.
<b>Operating Environment</b>	Select a CUPLA with design and materials that suit each operating environment.	In choosing the type of CUPLA, body material and seal material, consider the temperature range, and/or corrosive atmosphere in the operating environment.
<b>Size and Type of End Configurations</b>	Finally and critically specify the size and type of end configurations.	Having checked the type and materials for the CUPLA, now specify the size and type of end configurations to suit the type of piping. Choose carefully, as the size affects the fluid flow rate.

Note: End configuration and size may be limited by the type of CUPLA.



You can search our "CUPLA" at our web site. ([www.nitto-kohki.co.jp/e/](http://www.nitto-kohki.co.jp/e/)) Please take a visit.

If you cannot find a suitable "CUPLA", please contact us via our web site or enter the above details in the "CUPLA Inquiry Form" at the end of this catalog and send it to us by fax or post.

## Symbols

### Quick reference symbols:



(1) Working pressure, (2) Type of valve structure, (3) Applicable fluids, are given on each product page to help you to quickly select a suitable CUPLA. Please use them as the guide to grasp each type selection.





### Working pressure



1.0 MPa  
(10 kgf/cm<sup>2</sup>)

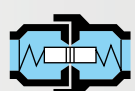











### Valve structure

Plug  Socket  Valve 

Two-way shut-off      Two-way shut-off (Non-Spill)      One-way shut-off      One-way shut-off      Straight through

### Applicable fluids

 Air	 Water	 Hydraulic oil	 Steam	 Oxygen, Fuel Gas	 Gas	 Inert gas, Vacuum, Helium
 Temperature control refrigerant	 High purity chemicals	 Heated oil	 Powder	 Solvent based paint	 Food, Drinking water	



# Glossary

The following terms are used in detailed information pages of each CUPLA. Refer to these terms when checking CUPLA specifications.

## International System of Units (SI Units)

Units stated in this catalog are based on SI Units. The old units, which are non-SI Units, are also written within parentheses side by side with SI Units for reference only.

## Glossary

### The Meaning of Each Letter in the Model Name

The model name of a CUPLA indicates its size, whether plug or socket, and the end configuration. Rated pressure is also shown for some hydraulic couplings. Check the following tables to understand the model name implication before making your selection.

**200 - 20 S H** Model name (in case of HI CUPLA 200)

**Series name**

**End configuration** \*2

Symbol	H	M	F
Meaning	Hose barb	Male thread	Female thread

**Plug or Socket**

Symbol	P	S
Meaning	Plug	Socket

**Size** \*1

Symbol	1	2	3	4	6	8	10	12	16	20	24	32
Nominal diameter	1/8"	1/4"	3/8"	1/2"	3/4"	1"	1 1/4"	1 1/2"	2"	2 1/2"	3"	4"

\*1: The digit numbers of models for some products differs from those of symbols. For example, in case of HI CUPLA 20SH, not "20" but only "2" of the "20" corresponds to "2" of the symbol and indicates the nominal diameter of 1/4".

\*2: For a product with only one type of end configuration, this symbol is omitted. For example, 210 CUPLA have only female threaded end so the model indicates only the size and plug or socket identification.

### Body Material

This indicates the material that is used for the plug body or socket body that forms the flow path of fluid through the CUPLA. Some products have internal components of a different material. Please check with us for details.

Body Material		Major applicable fluid
Common name	Mark	
Brass	BRASS	Air, Water, Oil
Iron, Steel	STEEL	Air, Oil
Stainless steel	SUS	Air, Water, Oil

Please refer to Page 158 for body material selection table.

### Size

This indicates the nominal size of the pipe thread connection or of the hose to be used.

### Working Pressure

The normal allowable fluid pressure under continuous use. Exceeding the working pressure may cause damage and leakage.

### Pressure Loss

This shows the loss of pressure when fluid runs through the CUPLA set. They are measured values at our testing facilities. May differ according to the installation/piping method and operating conditions.

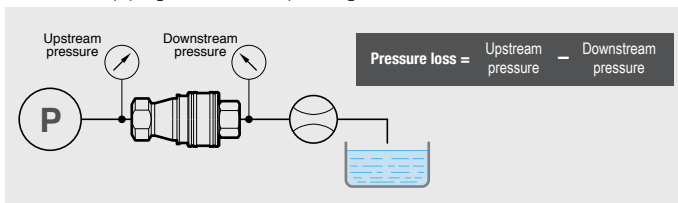

### Minimum Cross-Sectional Area

This shows the minimum cross-sectional area of the fluid path when the CUPLA is connected. The position is different in some products.

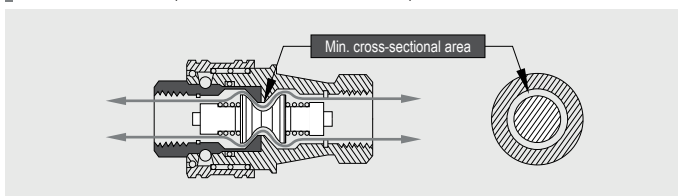

### Seal Material

This shows the material used to seal the CUPLA, usually an O-ring. The standard material is nitrile butadiene rubber. For materials other than those shown below, please specify such as silicone (SI), butyl (IIR), Kalrez (KL) or rubber for food, depending on your application.

#### Properties of rubbers used for O-rings

Seal material	Working Temperature Range	Features	
Nitrile rubber	-20°C to +80°C	Standard seal with excellent oil resistance.	
Hydrogenated nitrile rubber	HNBR	-20°C to +120°C	Compared with the standard nitrile rubber, the seal material is more heat and weather resistant.
	HNBR (H708)	-20°C to +120°C	In addition to the above features, the seal material can also be used for refrigeration oil and refrigerant applications such as HFC-134a. (The seal material is employed only in SP-V CUPLA and PCV PIPE CUPLA.)
Fluoro rubber	-20°C to +180°C	Excellent for heat, weather, and oil resistance. Applicable to wide range of applications.	
Chloroprene rubber	CR (X-306)	-20°C to +80°C	Excellent weather resistance.
	CR (C308)	-20°C to +80°C	In addition to the above features, the seal material can also be used for refrigeration oil and refrigerant applications such as HFC-134a.
Ethylene-propylene rubber	EPDM (EPT)	-40°C to +150°C	Excellent resistance to steam and hot water, also excellent resistance to weather and ozone.
Perfluoroelastomer	P	0°C to +50°C	Excellent resistance to chemical and solvents.

Note: Even among rubber materials of the same category, the working temperature range differs depending upon the design of the CUPLA. For details, see the specifications of each CUPLA series. As for the Nitto Kohki symbol for rubber material, fluoro rubber is designated as "FKM" or "X-100" for example. The above are general features, but the seal resistance depends on fluid temperature, fluid concentration, and additives contained in the fluid.

### Working Temperature Range

This shows the minimum and maximum working temperature range of the seal material used in the product. Continuous use at the minimum or maximum temperature is not recommended. Please contact us for consultation.

### Valve Structure

<b>Two-way shut-off</b>		Automatic shut-off valves are mounted in both plug and socket. The valves prevent spill out of fluid from the lines on disconnection.	
<b>Two-way shut-off (Spill Reduction)</b>		"Two-way shut-off" with spill reduction design allows extremely little admixture of air on connection and minimizes fluid spill out on disconnection.	
<b>One-way shut-off</b>		This design prevents fluid outflow only from the socket side on disconnection. Also available are plugs with an automatic shut-off valve.	
<b>Straight through</b>		Shut-off valve is equipped neither in plug nor in socket. Fluid flows out from either side on disconnection.	

### Suitability for Vacuum

Indicates if the CUPLA has necessary performance required for vacuum applications. (Note that the performance in connected state differs from that of disconnected state.)

### Interchangeability

Indicates whether the plug or socket of different series, types or models can be connected with each other.

### Maximum Tightening Torque, Tightening Torque Range







Considering the balance between possible leakage caused by loose fit and too much structural stress when a CUPLA is mounted on a workpiece, the appropriate screw-in torque value or range is suggested by the maker.

### Flow Direction

The design of some couplings may restrict the fluid flow direction to one way only. Check the suggested direction before installing.

# Guide for Selecting “NITTO KOHKI” Standard CUPLA



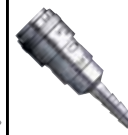





This chart will let you quickly select an appropriate CUPLA for your application. For technical data, please refer to the detailed information pages of each product, Seal Material Selection Table and Body Material Selection Table at the end of this catalog.

Applicable fluid		For Low Pressure (Air)							
Name		MICRO CUPLA	SMALL CUPLA	COMPACT CUPLA	CUBE CUPLA	SUPER CUPLA	HI CUPLA	HI CUPLA BL	HI CUPLA 200
Photo									
Body material • Working pressure (MPa)	Brass	1.0	1.0	1.0			1.0		
	Stainless steel	1.0		1.0			1.5	1.5	
	Steel					1.0	1.5	1.5	1.5
	Plastic				1.0				
	Others					1.0			
Body surface treatment		Plated (Brass only)	Chrome plated	—	—	Chrome plated (Steel only)	Chrome plated (Steel only)	Chrome plated (Steel only)	Chrome plated
Size	1/8"	○	○	○	○	○	○		
	1/4"		○			○	○	○	○
	5/16"								
	3/8"						○	○	○
	1/2"						○	○	○
	3/4"						○		
	1"						○		
	1 1/4"								
	1 1/2"								
	2"								
	2 1/2"								
	3"								
	4"								
Others	○	○	○	○	○	○	○	○	
Working temperature range		-20°C to +80°C (NBR)	-20°C to +80°C (NBR)	-20°C to +180°C (FKM)	-20°C to +60°C (NBR)	-20°C to +80°C (NBR)	-20°C to +80°C (NBR)	-20°C to +80°C (NBR)	-20°C to +60°C (NBR)
Seal material		NBR, FKM	NBR	FKM, EPDM	NBR	NBR	NBR, FKM	NBR	NBR
Connection method	Manual			○			○	○	
	Push-to-connect	○	○		○	○			○
Valve structure	Two-way shut-off			○	○				
	Two-way shut-off (Non-Spill)								
	One-way shut-off	○	○		○	○	○	○	○
	Straight through				○				
Detailed information page		21	25	27	29	33	35	37	39









# Guide for Selecting "NITTO KOHKI" Standard CUPLA

This chart will let you quickly select an appropriate CUPLA for your application. For technical data, please refer to the detailed information pages of each product, Seal Material Selection Table and Body Material Selection Table at the end of this catalog.

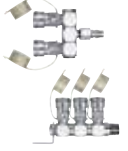
Applicable fluid		For Low Pressure (Air)							
Name		HI CUPLA for Connection to Braided Hoses	NUT CUPLA ROTARY NUT CUPLA	NUT CUPLA 200	LOCK CUPLA 200	HI CUPLA Two Way Type	FULL-BLOW CUPLA	PURGE HI CUPLA PVR	PURGE HI CUPLA
Photo									
Body material • Working pressure (MPa)	Brass	1.0							1.0
	Stainless steel								
	Steel	1.5	1.5	1.5	1.5	1.5			
	Plastic								
	Others						1.5	1.5	
Body surface treatment		Chrome plated (Steel only)	Chrome plated	Chrome plated	Chrome plated	Chrome plated	—	—	Chrome plated
Size	1/8"								
	1/4"				○	○	○		○
	5/16"								
	3/8"				○	○	○		○
	1/2"				○	○	○	○	○
	3/4"							○	○
	1"							○	
	1 1/4"								
	1 1/2"								
	2"								
	2 1/2"								
	3"								
	4"								
	Others	○	○	○	○		○		
Working temperature range		-20°C to +80°C (NBR)	-20°C to +60°C (NBR)	-20°C to +60°C (NBR)	-20°C to +60°C (NBR)	-20°C to +80°C (NBR)	-20°C to +60°C (NBR)	-20°C to +60°C (NBR)	-20°C to +60°C (NBR)
Seal material		NBR	NBR	NBR	NBR	NBR, FKM	NBR	NBR	NBR
Connection method	Manual	○	○			○			
	Push-to-connect			○	○		○	○	○
Valve structure	Two-way shut-off								
	Two-way shut-off (Non-Spill)								
	One-way shut-off	○	○	○	○	○	○	○	○
	Straight through								
Detailed information page		41	41	41	43	44	45	47	49

# Guide for Selecting “NITTO KOHKI” Standard CUPLA



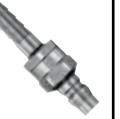





This chart will let you quickly select an appropriate CUPLA for your application. For technical data, please refer to the detailed information pages of each product, Seal Material Selection Table and Body Material Selection Table at the end of this catalog.

Applicable fluid		For Low Pressure (Air)							
Name		PURGE LINE CUPLA	ROTARY LINE CUPLA	LINE CUPLA 200T/L/S	ROTARY FULL-BLOW LINE CUPLA	HI CUPLA ACE	ROTARY PLUG	TWIST PLUG	PURGE PLUG
Photo									
Body material • Working pressure (MPa)	Brass	1.0							
	Stainless steel								
	Steel						1.5	1.0	1.0
	Plastic					1.0, 1.5			
	Others		1.5	1.5	1.5				
Body surface treatment		Chrome plated	Chrome plated	Chrome plated	—	—	Nickel plated	Nickel plated	Chrome plated
Size	1/8"							○	
	1/4"		○	○	○	○	○	○	○
	5/16"								
	3/8"					○	○	○	○
	1/2"	○	○	○	○				○
	3/4"								
	1"								
	1 1/4"								
	1 1/2"								
	2"								
	2 1/2"								
	3"								
	4"								
Others		○		○	○	○		○	
Working temperature range		-20°C to +60°C (NBR)	-20°C to +60°C (NBR)	-20°C to +60°C (NBR)	-20°C to +60°C (NBR)	-20°C to +60°C (NBR)	-20°C to +80°C (NBR)	-20°C to +60°C (NBR)	-20°C to +60°C (NBR)
Seal material		NBR	NBR	NBR	NBR	NBR	NBR	NBR	NBR
Connection method	Manual		○						
	Push-to-connect	○		○	○	○			
Valve structure	Two-way shut-off								
	Two-way shut-off (Non-Spill)								
	One-way shut-off	○	○	○	○	○			
	Straight through								
Detailed information page		50	51	53	55	57	59	60	61





## Guide for Selecting "NITTO KOHKI" Standard CUPLA

This chart will let you quickly select an appropriate CUPLA for your application. For technical data, please refer to the detailed information pages of each product, Seal Material Selection Table and Body Material Selection Table at the end of this catalog.

Applicable fluid		For Low Pressure (Air)				For Oxygen and Fuel Gas		For Low Pressure (Water)	
Name		ANTI-VIBRATION PLUG HOSE	DUSTER CUPLA	NK CUPLA HOSE	NK CUPLA COIL HOSE	MINI CUPLA	MINI CUPLA SUPER	MICRO CUPLA	SMALL CUPLA
Photo									
Body material • Working pressure (MPa)	Brass					0.7	0.7	1.0	1.0
	Stainless steel							1.0	
	Steel						0.7		
	Plastic								
	Others	1.5	1.0	1.0	0.7				
Body surface treatment		—	Chrome plated	Chrome plated (Plug only)	Chrome plated (Plug only)	—	Chrome plated	Plated (Brass only)	Chrome plated
Size	1/8"					○		○	○
	1/4"	○	○			○	○		○
	5/16"					○	○		
	3/8"	○	○			○	○		
	1/2"		○						
	3/4"								
	1"								
	1 1/4"								
	1 1/2"								
	2"								
	2 1/2"								
	3"								
	4"								
Others		○	○	○	○	○	○	○	○
Working temperature range		—	-20°C to +60°C (NBR)	-5°C to +60°C (NBR)	-5°C to +60°C (NBR)	-20°C to +80°C (NBR)	-20°C to +80°C (NBR)	-20°C to +80°C (NBR)	-20°C to +80°C (NBR)
Seal material		—	NBR	NBR	NBR	NBR	NBR	NBR, FKM	NBR
Connection method	Manual		○						
	Push-to-connect			○	○	○	○	○	○
Valve structure	Two-way shut-off								
	Two-way shut-off (Non-Spill)								
	One-way shut-off		○	○	○	○	○	○	○
	Straight through								
Detailed information page		62	63	64	64	65	67	21	25









# Guide for Selecting “NITTO KOHKI” Standard CUPLA

This chart will let you quickly select an appropriate CUPLA for your application. For technical data, please refer to the detailed information pages of each product, Seal Material Selection Table and Body Material Selection Table at the end of this catalog.

Applicable fluid		For Low Pressure (Water)							
Name		COMPACT CUPLA	CUBE CUPLA	HI CUPLA	HI CUPLA ACE	MOLD CUPLA	MOLD CUPLA High Flow Type	FLOW METER	LEVER LOCK CUPLA
Photo			Choose from 5 colors   <b>NEW</b>						
Body material • Working pressure (MPa)	Brass	1.0		1.0		1.0	1.0		
	Stainless steel	1.0		1.5					1.8, 1.6, 1.1
	Steel								
	Plastic		1.0		1.0, 1.5				0.5, 0.2
	Others							0.5	1.8, 1.1, 0.9, 0.7
Body surface treatment		—	—	—	—	—	—	—	—
Size	1/8"	○	○	○		○			
	1/4"			○	○	○	○		
	5/16"								
	3/8"			○	○	○	○	○	
	1/2"			○			○		
	3/4"			○					○
	1"			○					○
	1 1/4"								○
	1 1/2"								○
	2"								○
	2 1/2"								○
	3"								○
	4"								○
Others	○	○		○	○				
Working temperature range		-20°C to +180°C (FKM)	-20°C to +60°C (NBR)	-20°C to +80°C (NBR)	-20°C to +60°C (NBR)	-20°C to +80°C (NBR)	-20°C to +80°C (NBR)	+20°C to +60°C (NBR)	-20°C to +80°C (NBR) +5°C to +50°C (PP body)
Seal material		FKM, EPDM	NBR	NBR, FKM	NBR	NBR, FKM	NBR, FKM	NBR	NBR, FKM, SI, EPDM
Connection method	Manual	○		○					○
	Push-to-connect		○		○	○	○		
Valve structure	Two-way shut-off	○	○						
	Two-way shut-off (Non-Spill)								
	One-way shut-off		○	○	○	○	○		
	Straight through		○			○	○		○
Detailed information page		27	29	35	57	69	71	72	73

## Guide for Selecting "NITTO KOHKI" Standard CUPLA









This chart will let you quickly select an appropriate CUPLA for your application. For technical data, please refer to the detailed information pages of each product, Seal Material Selection Table and Body Material Selection Table at the end of this catalog.

Applicable fluid		For Medium Pressure / For Low Pressure				For Medium Pressure	For High Pressure		
Name		TSP CUPLA	TSP CUPLA with Ball Valve	SP CUPLA TYPE A	HOT WATER CUPLA HW Type	ZEROSPILL CUPLA	HSP CUPLA	HYPER HSP CUPLA	210 CUPLA
Photo									
Body material • Working pressure (MPa)	Brass	5.0, 3.0, 2.0, 1.5	1.0	5.0, 3.0, 2.0, 1.5	2.0	3.5			
	Stainless steel	7.5, 4.5, 3.0, 2.0		7.5, 4.5, 3.0, 2.0		3.5			
	Steel	7.5, 4.5, 3.0, 2.0		7.5, 4.5, 3.0, 2.0			20.6, 18.0, 14.0	20.6	20.6
	Plastic								
	Others								
Body surface treatment		Nickel plated (Steel only)	—	Nickel plated (Steel only)	Nickel plated	—	Nickel plated	Nickel plated	Nickel plated
Size	1/8"	○		○					
	1/4"	○	○	○	○	○	○	○	○
	5/16"								
	3/8"	○	○	○	○	○	○	○	○
	1/2"	○	○	○	○	○	○	○	○
	3/4"	○	○	○		○	○	○	○
	1"	○	○	○		○	○	○	○
	1 1/4"	○		○			○		
	1 1/2"	○		○			○		
	2"	○		○			○		
	2 1/2"								
	3"								
	4"								
Others	○								
Working temperature range		-20°C to +80°C (NBR)	-5°C to +120°C (FKM)	-20°C to +80°C (NBR)	-20°C to +180°C (FKM)	-20°C to +80°C (NBR)	-20°C to +80°C (NBR)	-20°C to +80°C (NBR)	-20°C to +80°C (NBR)
Seal material		NBR, FKM, EPDM	FKM	NBR, FKM, EPDM	FKM	NBR, FKM, EPDM	NBR, FKM	NBR	NBR, FKM
Connection method	Manual	○	○	○	○		○	○	○
	Push-to-connect					○			
Valve structure	Two-way shut-off			○	○		○	○	○
	Two-way shut-off (Non-Spill)					○			
	One-way shut-off		○						
	Straight through	○							
Detailed information page		77	79	81	83	85	87	89	91











# Guide for Selecting “NITTO KOHKI” Standard CUPLA

This chart will let you quickly select an appropriate CUPLA for your application. For technical data, please refer to the detailed information pages of each product, Seal Material Selection Table and Body Material Selection Table at the end of this catalog.

Applicable fluid		For High Pressure							
Name		HSU CUPLA	S210 CUPLA	280 CUPLA	350 CUPLA	FLAT FACE CUPLA F35	FLAT FACE CUPLA FF	450B CUPLA	700R CUPLA
Photo									
Body material	Brass								
	Stainless steel	21.0	20.6						
	Working pressure (MPa)			31.5, 27.5	34.5	35	35	44.1	68.6
	Steel								
	Plastic								
	Others								
Body surface treatment		—	—	Bright chromate conversion coating	Nickel plated	Nickel plated	Nickel plated	Nickel plated	Nickel plated
Size	1/8"								
	1/4"	○	○	○	○	○			
	5/16"								
	3/8"	○	○	○	○	○	○	○	○
	1/2"	○	○	○	○	○	○	○	○
	3/4"	○	○	○	○	○	○	○	○
	1"	○	○	○	○	○	○	○	○
	1 1/4"				○				
	1 1/2"				○				
	2"								
	2 1/2"								
	3"								
	4"								
Others									
Working temperature range		-20°C to +120°C (HNBR)	-20°C to +180°C (FKM)	-20°C to +80°C (NBR)	-20°C to +180°C (FKM)	-20°C to +180°C (FKM)	-20°C to +80°C (NBR)	-20°C to +80°C (NBR)	-20°C to +80°C (NBR)
Seal material		HNBR	FKM, NBR	NBR	FKM, NBR	FKM, NBR	NBR	NBR, FKM	NBR, FKM
Connection method	Manual	○	○	○				○	○
	Push-to-connect				○	○	○		
Valve structure	Two-way shut-off	○	○	○				○	○
	Two-way shut-off (Non-Spill)				○	○	○		
	One-way shut-off								
	Straight through								
Detailed information page		93	95	97	99	101	103	105	106









# Guide for Selecting "NITTO KOHKI" Standard CUPLA

This chart will let you quickly select an appropriate CUPLA for your application. For technical data, please refer to the detailed information pages of each product, Seal Material Selection Table and Body Material Selection Table at the end of this catalog.

Applicable fluid		For Multi-Port Connection (Manual)			For Multi-Port Connection (Automatic)				
Name		MULTI CUPLA MAM Type	MULTI CUPLA MAM-B Type	MULTI CUPLA MAM-A Type	MULTI CUPLA MAS Type	MULTI CUPLA MAT Type	MULTI CUPLA MALC-01 Type	MULTI CUPLA MALC-SP Type	MULTI CUPLA MALC-HSP Type
Photo									
Body material • Working pressure (MPa)	Brass	0.7	1.0	1.0			1.0		
	Stainless steel				7.0	7.0		7.5, 5.0, 1.5	
	Steel								25.0, 21.0
	Plastic								
	Others								
Body surface treatment		Chrome plated	Nickel plated	Nickel plated	Nickel plated	Nickel plated	Nickel plated	Nickel plated	Nickel plated
Size	1/8"	○	○				○	○	○
	1/4"		○	○	○	○		○	○
	5/16"								
	3/8"			○	○	○		○	○
	1/2"			○	○	○		○	○
	3/4"				○	○		○	○
	1"				○	○		○	○
	1 1/4"								
	1 1/2"							○	
	2"								
	2 1/2"								
	3"								
	4"								
Others							○	○	○
Working temperature range		-20°C to +60°C (NBR)	-20°C to +180°C (FKM)	-20°C to +180°C (FKM)	-20°C to +180°C (FKM)	-20°C to +180°C (FKM)	-20°C to +80°C (NBR)	-20°C to +180°C (FKM)	-20°C to +180°C (FKM)
Seal material		NBR	FKM	FKM	FKM	FKM	NBR	FKM	FKM
Connection method	Manual								
	Push-to-connect								
Valve structure	Two-way shut-off		○	○	○	○			
	Two-way shut-off (Non-Spill)						○	○	
	One-way shut-off	○					○		
	Straight through								
Detailed information page		107	109	113	117	117	119	121	125



# Guide for Selecting “NITTO KOHKI” Standard CUPLA

This chart will let you quickly select an appropriate CUPLA for your application. For technical data, please refer to the detailed information pages of each product, Seal Material Selection Table and Body Material Selection Table at the end of this catalog.

Applicable fluid		For High Purity Chemicals						For Inert Gas and Vacuum	
Name		SEMICON CUPLA SP Type	SEMICON CUPLA SCS Type	SEMICON CUPLA SCY Type	SEMICON CUPLA SCT Type	SEMICON CUPLA SCAL Type	SEMICON CUPLA SCF Type	SP-V CUPLA	PCV PIPE CUPLA
Photo									
Body material • Working pressure (MPa)	Brass							5.0, 3.0	4.5
	Stainless steel	0.2	0.2	0.2				7.5, 4.5	
	Steel								
	Plastic				0.2	0.2	0.2		
	Others								
Body surface treatment		Electropolished	Electropolished	Electropolished	—	—	—	—	—
Size	1/8"	○	○	○					
	1/4"	○	○	○	○	○		○	○
	5/16"								
	3/8"	○	○	○	○	○	○	○	○
	1/2"	○	○	○	○	○	○	○	
	3/4"	○	○	○	○	○		○	
	1"	○	○	○	○	○			
	1 1/4"								
	1 1/2"					○			
	2"								
	2 1/2"								
	3"								
	4"								
	Others						○		○
Working temperature range		0°C to +50°C (FKM)	0°C to +50°C (P)	0°C to +50°C (P)	+5°C to +50°C (FKM)	+5°C to +50°C (FKM)	+5°C to +50°C (FKM)	-20°C to +80°C (CR)	-20°C to +80°C (CR)
Seal material		FKM, EPDM, P, KL	P (O-ring for socket)	P, PTFE (Packing seal for socket)	FEP-coated FKM	P (O-ring for socket)	FEP-coated FKM	CR, FKM, HNBR	CR, FKM, HNBR
Connection method	Manual	○	○	○	○			○	○
	Push-to-connect					○	○		
Valve structure	Two-way shut-off	○	○	○	○		○	○	
	Two-way shut-off (Non-Spill)					○			
	One-way shut-off								
	Straight through								○
Detailed information page		129	130	131	132	133	134	135	137

## Guide for Selecting "NITTO KOHKI" Standard CUPLA

This chart will let you quickly select an appropriate CUPLA for your application. For technical data, please refer to the detailed information pages of each product, Seal Material Selection Table and Body Material Selection Table at the end of this catalog.



Applicable fluid		For Paint	For Food
Name		PAINT CUPLA	HYGIENIC CUPLA Easy Wash Type
Photo			
Body material • Working pressure (MPa)	Brass		
	Stainless steel	1.0 (Plug)	1.0
	Steel		
	Plastic		
	Others	1.0 (Socket)	
Body surface treatment		—	Buff finish #400 (liquid contact part)
Size	1/8"		
	1/4"		
	5/16"		
	3/8"	○	
	1/2"		
	3/4"		
	1"		
	1 1/4"		
	1 1/2"		
	2"		
	2 1/2"		
	3"		
	4"		
	Others		○
Working temperature range		0°C to +50°C (PFA)	0°C to +110°C (SI)
Seal material		PFA	SI, FKM, EPDM
Connection method	Manual	○	
	Push-to-connect		○
Valve structure	Two-way shut-off		
	Two-way shut-off (Non-Spill)		
	One-way shut-off	○	
	Straight through		○
Detailed information page		139	141



# Semi-standard CUPLA Series

“Semi-standard CUPLA Series” are products with an already established record but are not standard stock items.

# Accessories

CUPLA Safety Mechanism	For Water
<b>CUPLA with Single Lock</b> 143 Page Accidental disconnection prevention mechanism 	<b>TSP-HP CUPLA (for High Pressure)</b> 144 Page High pressure and general purpose type  Valve structure: Straight through Working pressure : 9.0 MPa (92 kgf/cm <sup>2</sup> ) Body material : Stainless steel Application : 1/4" to 1/2" Seal material : NBR, etc.
<b>CUPLA with Safety Lock</b> 143 Page Accidental disconnection prevention mechanism 	

## For Medium Pressure

	<b>SP CUPLA Type A PV Type</b> 147 Page Connectable with residual pressure With Purge Valve  Valve structure: Two-way shut-off Working pressure : 2.0 to 4.5 MPa (20 to 46 kgf/cm <sup>2</sup> ) Body material : brass, Stainless steel Application : Rc 3/4 to Rc 1 1/2 Seal material : NBR
--	---

## For Temperature Controllers

<b>MYU CUPLA</b> 144 Page For small bore piping (10 mm OD) for temperature control Applicable fluid : Water, gas, air  Valve structure: Two-way shut-off Working pressure : 1.0 MPa (10 kgf/cm <sup>2</sup> ) Body material : Stainless steel, brass (Plated) Application : Please let us know the required sizes and end configurations. Seal material : NBR, EPDM, FKM	
---	--

## For Low Pressure (air)

<b>LITTLE CUPLA</b> 144 Page For small bore piping (14 mm OD) for temperature control Applicable fluid : Water, gas, air  Valve structure: Two-way shut-off Working pressure : 1.5 MPa (15 kgf/cm <sup>2</sup> ) Body material : Stainless steel Application : Please let us know the required sizes and end configurations. Seal material : NBR, EPDM, FKM	
---	--

<b>PLASTIC CUPLA BC Type</b> 148 Page Valveless type for low pressure air piping  Valve structure: Straight through Working pressure : 0.07 MPa (0.7 kgf/cm <sup>2</sup> ) Body material : Plastic Application : 1/4", 3/8" Seal material : NBR	
---	--

<b>HIGH FLOW CUPLA</b> 145 Page For piping to control temperatures Applicable fluid: Water, Heat transfer fluids  Valve structure: Two-way shut-off Working pressure : 1.0 MPa (10 kgf/cm <sup>2</sup> ) Body material : Stainless steel, brass Application : 1/4" to 1/2" Seal material : EPDM, FKM	
---	--

<b>PLASTIC CUPLA BCC Type</b> 148 Page Equipped with flow controller for low pressure air piping  Valve structure: One-way shut-off Working pressure : 0.07 MPa (0.7 kgf/cm <sup>2</sup> ) Body material : Plastic Application : 3/8" Seal material : NBR	
---	--

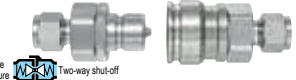
<b>HIGH FLOW CUPLA BI Type</b> 146 Page HIGH FLOW CUPLA with ferrule flange mount Applicable fluid: Water, Heat transfer fluids  Valve structure: Two-way shut-off Working pressure : 1.0 MPa (10 kgf/cm <sup>2</sup> ) Body material : Stainless steel Application : 1/8" to 1/2" Seal material : EPDM, FKM	
---	--

### When placing your order

Please select your appropriate combination from the column in each product page (on the right beside the product name) then decide the seal and body materials from the selection tables listed at the end of the catalog.

























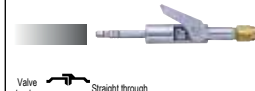





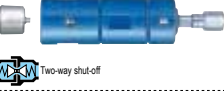



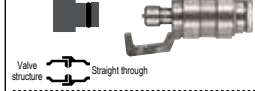



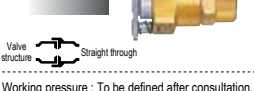

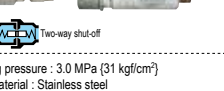

Accessories	
<b>DIP MOLD DUST CAP</b> 149 Page DUST CAPS for HI CUPLA, SP CUPLA Type A, TSP CUPLA, ZEROSPILL CUPLA and HYDRAULIC CUPLA 	<b>SLEEVE STOPPER</b> 151 Page Sleeve Stopper for SP CUPLA Type A 
<b>SAFETY CAP</b> 149 Page Metal caps for HI CUPLA Series, SP CUPLA Type A, TSP CUPLA and HYDRAULIC CUPLA •Semi-standard 	<b>ACCESSORIES FOR O-RING MAINTENANCE</b> 151 Page Jigs & grease for replacement of O-rings for couplings For SP CUPLA Type A, TSP CUPLA, HOT WATER CUPLA, ZEROSPILL CUPLA, HSP CUPLA, HSU CUPLA and HYGIENIC CUPLA 
<b>DUST CAP</b> 150 Page Plastic cap for HI CUPLA Series 	<b>RESIDUAL PRESSURE RELEASE JIG</b> 152 Page Residual Pressure Release Jig for SP CUPLA and HYDRAULIC CUPLA 
<b>DUST CAP</b> 150 Page Dedicated polyethylene cap for HYGIENIC CUPLA 	<b>CUPLA ADAPTER for Braided Hose Connection</b> 152 Page Mounts on CUPLA plug / socket with female thread 
<b>SLEEVE COVER</b> 150 Page Plastic cover for HI CUPLA Series 	<b>PURGE ADAPTER</b> 153 Page Residual Pressure Purge Adapter for Hydraulic Lines 
<b>PROTECTION COVER</b> 150 Page Plastic Cover for NUT CUPLA and FULL-BLOW CUPLA Nut Type 	<b>CUPLA CONNECTING JIG</b> 154 Page Connecting Jig for large CUPLA 
<b>DRAIN COCK / PRESSURE GAUGE</b> 151 Page Accessories for Air Lines of HI CUPLA Series 	

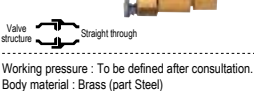
# Special Made-to-Order CUPLA

Nitto Kohki is developing couplings with various functions and specifications to suit respective user's applications. The CUPLA products on this page are examples of such.

**Important notice**

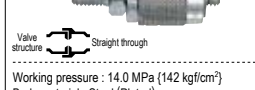
Special made-to-order couplings are supplied based upon the specific instructions / specifications detailed by the customer. Once written acceptance of our final drawing / specifications of the CUPLA is received from the customer we formally accept this as a final order. It is essential, as the customer, to carry out a performance test of the special made-to-order CUPLA, in its specific usage conditions, for assurance of safety and adaptability to the hoses, pipes or devices used in the application. Use of the made-to-order CUPLA in any application or condition other than those specified in the design drawing, will exclude Nitto Kohki from any liabilities for any special, indirect or consequential loss or damages.

For Inert Gases	For Gases and Liquids (PIPE CUPLA Series)	For Inert Gas and Vacuum	For High Purity Chemicals	Automatic MULTI CUPLA
<b>CHARGE CUPLA cs Type</b> For industrial gases Connectable to SP-V CUPLA plugs  Valve structure:  Working pressure : 3.0 MPa (31 kgf/cm <sup>2</sup> ) Body material : Stainless steel (part Aluminum alloy and Brass) Application : 1/4" Seal material : CR, HNBR	<b>PCB CUPLA</b> For expanded pipes  Valve structure:  Working pressure : To be defined after consultation. Body material : Brass (part Stainless steel) Pipe sizes : To be complied with your requirements. Seal material : CR, FKM, NBR	<b>PCA CUPLA</b> Pipes for high pressure line  Valve structure:  Working pressure : To be defined after consultation. Body material : Brass (part Stainless steel and Steel) Pipe sizes : To be complied with your requirements. Seal material : CR, FKM, NBR	<b>SEMICON CUPLA SML Type</b> For semiconductor manufacturing equipment  Valve structure:  Working pressure : 0.2 MPa (2 kgf/cm <sup>2</sup> ) Body material : Stainless steel Application : 1/8", 1/4" Seal material : FKM, EPDM, others	<b>MULTI CUPLA AMCS-FA Type</b> Full automatic operation type  Valve structure:  Working pressure : To be decided after consultation. Body material : To be decided after consultation. Application : To be decided after consultation. Seal material : To be decided after consultation.
<b>CHARGE CUPLA CNR Type</b> For industrial gases Connectable to SP-V CUPLA plugs  Valve structure:  Working pressure : 4.5 MPa (46 kgf/cm <sup>2</sup> ) Body material : Stainless steel (part Aluminum alloy and Brass) Application : 1/4", 3/8", 1/2" Seal material : CR, HNBR	<b>PCBW CUPLA</b> For bulged pipes and spool pipes  Valve structure:  Working pressure : To be defined after consultation. Body material : Brass (part Stainless steel) Pipe sizes : To be complied with your requirements. Seal material : CR, FKM, NBR	<b>PCIO CUPLA</b> For pipes that have inner locking system  Valve structure:  Working pressure : To be defined after consultation. Body material : Stainless steel (part Brass) Pipe sizes : To be complied with your requirements. Seal material : CR, FKM, NBR	<b>SEMICON CUPLA scf Straight Type</b> For semiconductor manufacturing equipment • see page 134  Valve structure:  Working pressure : 0.2 MPa (2 kgf/cm <sup>2</sup> ) Body material : Fluorine contained resin Application : 3/8", 1/2" Seal material : FEP-coated FKM, Fluoro-resin	<b>MULTI CUPLA AMCS-SA Type</b> Semi-automatic type  Valve structure:  Working pressure : To be decided after consultation. Body material : To be decided after consultation. Application : To be decided after consultation. Seal material : To be decided after consultation.
<b>AUTO CUPLA AC Type</b> For industrial gases Connectable to SP-V CUPLA plugs  Valve structure:  Working pressure : 3.0 MPa (31 kgf/cm <sup>2</sup> ) Body material : Stainless steel (part Aluminum alloy and Brass) Application : 1/4", 3/8" Seal material : CR, HNBR, NBR	<b>PCP CUPLA</b> For bulged pipes and spool pipes  Valve structure:  Working pressure : To be defined after consultation. Body material : POM (Polyacetal), part Stainless steel Pipe sizes : To be complied with your requirements. Seal material : CR, FKM, NBR	<b>PCD CUPLA</b> For pipes of special shapes  Valve structure:  Working pressure : To be defined after consultation. Body material : Stainless steel (part Aluminum alloy) Pipe sizes : To be complied with your requirements. Seal material : CR, FKM, NBR	<b>For Water</b>	
<b>AUTO CUPLA ACV Type</b> For industrial gases Connectable to SP-V CUPLA plugs  Valve structure:  Working pressure : 3.0 MPa (31 kgf/cm <sup>2</sup> ) Body material : Stainless steel (part Aluminum alloy and Brass) Application : 1/4", 3/8" Seal material : CR, HNBR, NBR	<b>PCBL CUPLA</b> For straight pipes  Valve structure:  Working pressure : To be defined after consultation. Body material : Stainless steel (part Brass) Pipe sizes : To be complied with your requirements. Seal material : CR, FKM, NBR	<b>AUTO CUPLA</b> For copper pipes  Valve structure:  Working pressure : To be defined after consultation. Body material : Stainless steel (part Brass) Pipe sizes : To be complied with your requirements. Seal material : CR, FKM, NBR		
<b>AIRLESS CUPLA CNA Type</b> For industrial gases  Valve structure:  Working pressure : 3.0 MPa (31 kgf/cm <sup>2</sup> ) Body material : Steel Application : 3/8" Seal material : CR, HNBR	<b>PCL CUPLA</b> For straight pipes  Valve structure:  Working pressure : To be defined after consultation. Body material : Steel Pipe sizes : To be complied with your requirements. Seal material : CR, FKM, NBR	<b>SCREW CUPLA PCs Type</b> For vacuum and pressure testing Please consult with us for larger sizes.  Valve structure:  Working pressure : 3.0 MPa (31 kgf/cm <sup>2</sup> ) Body material : Steel (part Stainless steel) Application : 7/16" to 7/8" Seal material : CR, NBR, FKM	<b>For Manipulators</b>	
<b>PCW CUPLA</b> For straight pipes  Valve structure:  Working pressure : To be defined after consultation. Body material : Brass (part Stainless steel and Steel) Pipe sizes : To be complied with your requirements. Seal material : CR, FKM, NBR	<b>For Pneumatics and Hydraulics</b>			
<b>SCREW CUPLA NCM Type</b> For connecting pneumatic/hydraulic lines  Valve structure:  Working pressure : 14.0 MPa (142 kgf/cm <sup>2</sup> ) Body material : Steel (Plated) Application : 1/8" to 1" Seal material : NBR			<b>SAFETY EQUIPMENT</b>	

**When placing your order**  
 Please ask about the details, since the CUPLA products in this group are special made-to-order items.

# HI CUPLA Series Interchangeability

Following plugs and sockets can be connected with each other

Plug		
Type	Model	
HI CUPLA	17PH, 20PH, 30PH, 40PH 10PM, 20PM, 30PM, 40PM 20PF, 30PF, 40PF 20PFF 60PC, 80PC, 100PC 90PN-BH	
	NUT CUPLA	50PN (10PAH), 60PN (20PAH), 65PN 80PN (30PAH), 85PN, 110PN (40PAH) 50PNG, 65PNG, 85PNG
	HI CUPLA ACE	20PH-PLA, 30PH-PLA 20PM-PLA, 30PM-PLA 50PN-PLA, 60PN-PLA, 65PN-PLA, 80PN-PLA, 85PN-PLA 20PFF-PLA 50PNG-PLA, 65PNG-PLA, 85PNG-PLA
	ROTARY PLUG	RL-20PM, RL-30PM RL-20PFF
	TWIST PLUG	TS-10PM, TS-20PM, TS-30PM TS-20PFF
	PURGE PLUG	PV-20PH, PV-30PH, PV-40PH PV-65PN, PV-85PN
ANTI-VIBRATION PLUG HOSE	SHA-3-2R, SHA-3-3R	
NK CUPLA HOSE	NKU-605B, NKU-610B, NKU-620B (65PNG)	
	NKU-810B, NKU-820B (85PNG)	
NK CUPLA COIL HOSE	NKC-503B, NKC-505B (50PNG)	
	NKC-603B, NKC-605B (65PNG)	
ROTARY LINE CUPLA	RT Type (Inlet Port)	
LINE CUPLA 200	200T Type (Inlet Port)	
ROTARY FULL-BLOW LINE CUPLA	FBH-RT Type (Inlet Port)	
HI CUPLA ACE T TYPE	HA-T Type (Inlet Port)	
ACCESSORIES FOR AIR LINES	DC-30PF, PG-10P	
SUPER CUPLA	02S20P (End Configuration)	

Can be connected with each other



Socket	
Model	Type
17SH, 20SH, 30SH, 40SH 10SM, 20SM, 30SM, 40SM 20SF, 30SF, 40SF 90SN-BH	HI CUPLA
20SH-BL, 30SH-BL, 40SH-BL 20SM-BL, 30SM-BL, 40SM-BL 20SF-BL, 30SF-BL, 40SF-BL 65SN-BL, 80SN-BL, 85SN-BL	HI CUPLA BL
TW20SH, TW30SH, TW40SH TW20SM, TW30SM, TW40SM TW20SF, TW30SF, TW40SF	HI CUPLA TW Type
200-17SH, 200-20SH, 200-30SH, 200-40SH 200-20SM, 200-30SM, 200-40SM 200-20SF, 200-30SF, 200-40SF 200-60SC, 200-80SC, 200-100SC	HI CUPLA 200
FBH-20SH, FBH-30SH, FBH-40SH FBH-20SM, FBH-30SM, FBH-40SM FBH-20SF, FBH-30SF, FBH-40SF FBH-65SN, FBH-80SN, FBH-85SN, FBH-110SN	FULL-BLOW CUPLA
50SN (10SAH), 60SN (20SAH), 65SN 80SN (30SAH), 85SN, 110SN (40SAH) 200-50SN, 200-60SN, 200-65SN, 200-80SN 200-85SN, 200-110SN 200-50SNG, 200-65SNG, 200-85SNG	NUT CUPLA
65SNR, 85SNR 65SNRG, 85SNRG	NUT CUPLA 200
DCS-20PH, DCS-30PH, DCS-40PH DCS-65PNG, DCS-85PNG	ROTARY NUT CUPLA
L200-20SH, L200-30SH, L200-40SH L200-20SM, L200-30SM, L200-40SM L200-20SF, L200-30SF, L200-40SF L200-65SNRG, L200-85SNRG	DUSTER CUPLA
PV-20SM, PV-30SM, PV-40SM RE-PV-30 (Outlet Port)	LOCK CUPLA 200
RT Type (Outlet Port), RE Type (Outlet Port)	PURGE HI CUPLA
200T Type (Outlet Port), 200L Type (Outlet Port), 200S Type (Outlet Port)	PURGE LINE CUPLA
FBH-RE Type (Outlet Port), FBH-RT Type (Outlet Port)	ROTARY LINE CUPLA
HA-20SH, HA-30SH HA-20SM, HA-30SM, HA-50SN, HA-60SN HA-65SN, HA-80SN, HA-85SN HA-T Type (Outlet Port) HA-50SNG, HA-65SNG, HA-85SNG	LINE CUPLA 200
NKU-605B, NKU-610B, NKU-620B (HA-65SNG) NKU-810B, NKU-820B (HA-85SNG)	ROTARY FULL-BLOW LINE CUPLA
NKC-503B, NKC-505B (HA-50SNG) NKC-603B, NKC-605B (HA-65SNG)	HI CUPLA ACE
	NK CUPLA HOSE
	NK CUPLA COIL HOSE

Not interchangeable

Can be connected with each other



Plug	
Type	Model
HI CUPLA	400PH, 600PH, 800PH 400PM, 600PM, 800PM 400PF, 600PF, 800PF
LINE CUPLA 200	200L Type (Inlet Port) 200S Type (Inlet Port)

Socket	
Model	Type
400SH, 600SH, 800SH 400SM, 600SM, 800SM 400SF, 600SF, 800SF	HI CUPLA
PV-400SM, PV-600SM	PURGE HI CUPLA
PVR-400SH, PVR-600SH, PVR-800SH PVR-400SM, PVR-600SM, PVR-800SM PVR-400SF, PVR-600SF, PVR-800SF	PURGE HI CUPLA PVR Type



## Index

### Examples of air line connections using HI CUPLA group models

Air distribution is one of the typical piping systems. Various HI CUPLA Series models meet all needs of air piping from main supply, relays in factories, pipe end connections to pneumatic tools, and those of air piping within equipment. The following sketch gives you some examples of air piping using HI CUPLA Series and may serve as a good reference in selecting appropriate CUPLA products.

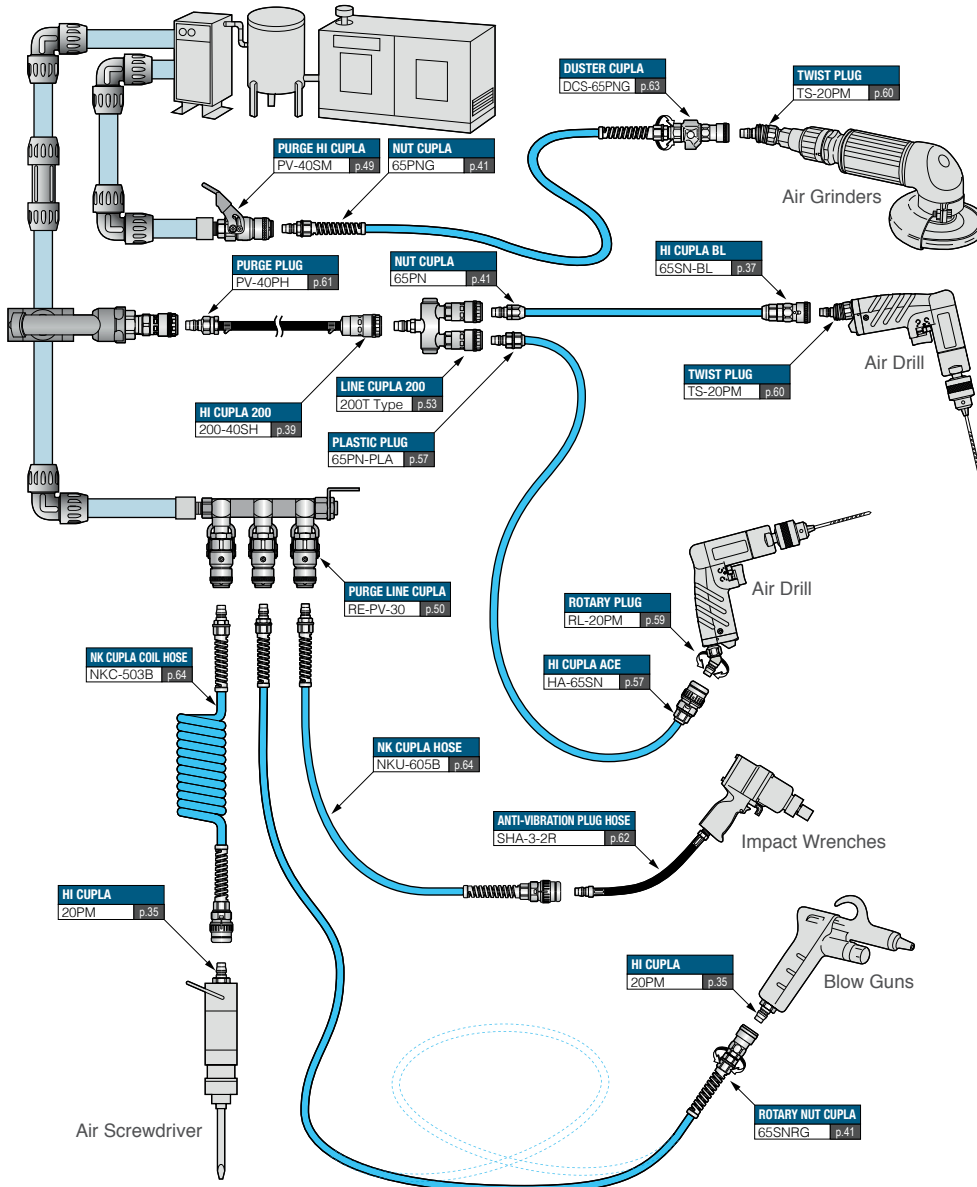



	Product Name	Page
<b>2</b>	210 CUPLA	91
	280 CUPLA	97
<b>3</b>	350 CUPLA	99
<b>4</b>	450B CUPLA	105
<b>7</b>	700R CUPLA	106
<b>A</b>	ANTI-VIBRATION PLUG HOSE	62
<b>C</b>	COMPACT CUPLA	27
	CUBE CUPLA	<b>NEW</b> 29
<b>D</b>	DUSTER CUPLA	63
<b>F</b>	FLAT FACE CUPLA F35	101
	FLAT FACE CUPLA FF	102
	FLOW METER	72
	FULL-BLOW CUPLA	45
<b>H</b>	HI CUPLA	35
	HI CUPLA 200	39
	HI CUPLA ACE	57
	HI CUPLA BL	37
	HI CUPLA for Connection to Braided Hoses	41
	HI CUPLA Two Way Type	44
	HOT WATER CUPLA HW Type	83
	HSP CUPLA	87
	HSU CUPLA	93
	HYGIENIC CUPLA	141
	HYPER HSP CUPLA	89
<b>L</b>	LEVER LOCK CUPLA Metal Body	73
	LEVER LOCK CUPLA Plastic Body	73
	LINE CUPLA 200	53
	LOCK CUPLA 200	43
<b>M</b>	MICRO CUPLA	21
	MINI CUPLA	65
	MINI CUPLA SUPER	67
	MOLD CUPLA	69
	MOLD CUPLA High Flow Type	71
	MULTI CUPLA MALC-01 Type	119
	MULTI CUPLA MALC-HSP Type	125
	MULTI CUPLA MALC-SP Type	121
	MULTI CUPLA MAM-A Type	113
	MULTI CUPLA MAM-B Type	109
	MULTI CUPLA MAM Type	107
	MULTI CUPLA MAS Type	117
	MULTI CUPLA MAT Type	117
<b>N</b>	NK CUPLA COIL HOSE	64
	NK CUPLA HOSE	64
	NUT CUPLA	41
	NUT CUPLA 200	41
<b>P</b>	PAINT CUPLA	139
	PCV PIPE CUPLA	137
	PURGE HI CUPLA	49
	PURGE HI CUPLA PVR Type	47
	PURGE LINE CUPLA	50
	PURGE PLUG	61
<b>R</b>	ROTARY FULL-BLOW LINE CUPLA	55
	ROTARY LINE CUPLA	51
	ROTARY NUT CUPLA	41
	ROTARY PLUG	59
<b>S</b>	S210 CUPLA	95
	SEMICON CUPLA SCAL Type	133
	SEMICON CUPLA SCF Type	134
	SEMICON CUPLA SP Type	129
	SEMICON CUPLA SCS Type	130
	SEMICON CUPLA SCT Type	132
	SEMICON CUPLA SCY Type	131
	SMALL CUPLA	25
	SP CUPLA Type A	81
	SP-V CUPLA	135
	SUPER CUPLA	33
<b>T</b>	TSP CUPLA	77
	TSP CUPLA with Ball Valve	79
	TWIST PLUG	60
<b>Z</b>	ZEROSPILL CUPLA	85



For Low Pressure

# MICRO CUPLA

For piping in pneumatic control devices

<b>Working pressure</b>  1.0 MPa {10 kgf/cm <sup>2</sup> }	<b>Valve structure</b>  One-way shut-off	<b>Applicable fluids</b>  Air Water (Tube Fitter type is unsuitable for water.)
---	---	---

**Compact, lightweight CUPLA with only 9.5 mm outer diameter.**  
**Push-to-connect operation. Tube Fitter type for even easier tube insertion.**

- Even though the valve is built in the socket, the sleeve outer diameter is confined to 9.5 mm.
- Push-to-connect design.
- Compact design for piping in narrow spaces.
- Plated brass and stainless steel bodies are available for excellent corrosion resistance.
- Available in various end configurations to satisfy a wide range of pneumatic applications.

**Note:** Fluid will flow out from the plug side when disconnected.  
Take necessary precaution if the fluid is water.

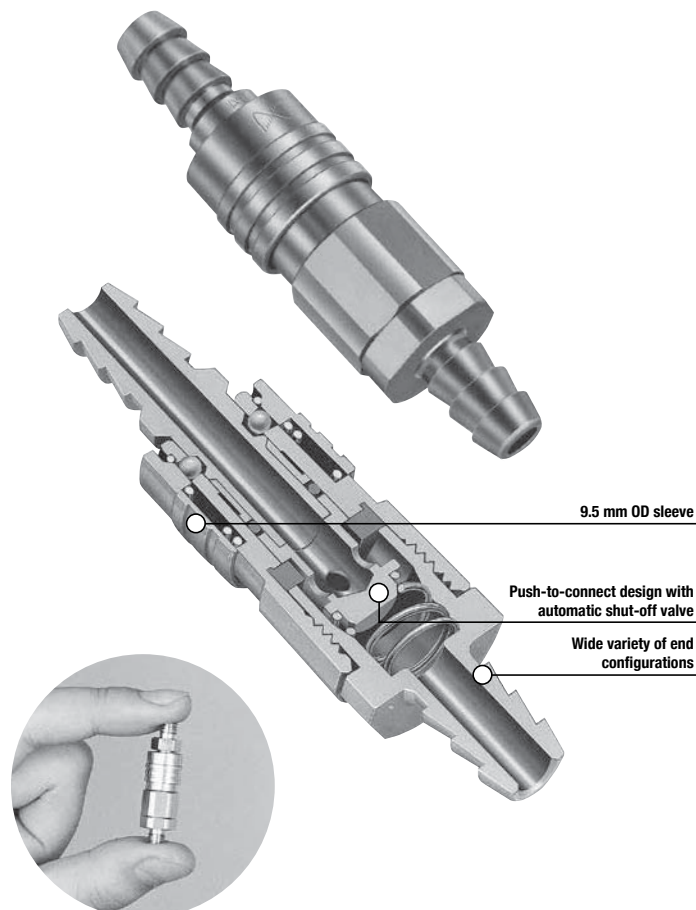

## Specifications

<b>Body material</b>		CUPLA : Brass (Plated), Stainless steel (SUS 304) Tube Fitter Part : Brass (Plated) , Plastic			
<b>Size</b>	<b>Thread</b>	1/8" , M5 x 0.8			
	<b>Tube barb (Tube fitter)</b>	Tube ID ø3, ø4 Polyurethane tube: Outside Dia. ø4 ± 0.1, ø6 ± 0.1 Polyamide tube: Outside Dia. ø4 <sup>+0.05</sup> <sub>-0.08</sub> , ø6 <sup>+0.05</sup> <sub>-0.08</sub> Fluorine contained resin tube: Outside Dia. ø4 ± 0.05, ø6 ± 0.07			
<b>Pressure unit</b>	<b>MPa</b>	<b>kgf/cm<sup>2</sup></b>	<b>bar</b>	<b>PSI</b>	
<b>Working pressure</b>	1.0	10	10	145	
<b>Seal material</b> <b>Working temperature range</b>	<b>Seal material</b>	<b>Mark</b>	<b>Working temperature range</b>	<b>Remarks</b>	
	Nitrile rubber	NBR (SG)	-20°C to +80°C	Standard material	
	Fluoro rubber	FKM (X-100)	-20°C to +180°C	Made-to-order item(s)	

\* Above specifications apply only to CUPLA. Maximum working pressure and working temperature range may vary depending on tube materials you use with and the working temperature.  
CUPLA with Tube Fitter has NBR packing material only.

## Maximum Tightening Torque Nm {kgf·cm}

<b>Size (Thread)</b>	<b>M5x0.8</b>	<b>R 1/8</b>
<b>Torque</b>	<b>Brass</b>	5 {51}
	<b>Stainless steel</b>	7 {71}

## Flow Direction

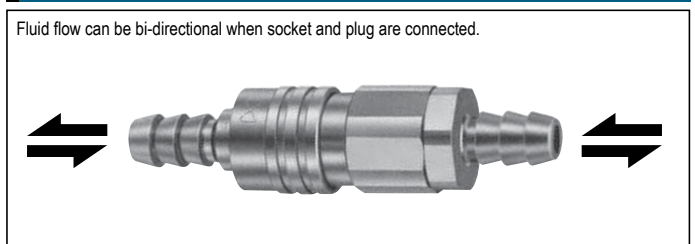

## Interchangeability

Sockets and plugs can be connected regardless of end configurations.

## Minimum Cross-Sectional Area (mm<sup>2</sup>)

<b>Model</b>	<b>MC-03SP</b>	<b>MC-04SP</b>	<b>MC-05SP</b>	<b>MC-10SP</b>	<b>Tube Fitter Type for 4 mm OD tube</b>	<b>Tube Fitter Type for 6 mm OD tube</b>
<b>Min. cross-sectional area</b>	1.1	4.9	4.9	4.9	4.9	4.9

## Suitability for Vacuum 53.0 kPa {400 mmHg}

<b>Socket only</b>	<b>Plug only</b>	<b>When connected</b>
—	—	Operational

## Pressure - Flow Characteristics

[Test conditions] • Fluid : Air • Temperature : Room temperature  
• Tube size : ø4 mm x ø2 mm, ø6 mm x ø4 mm (Micro Cupla with Tube Fitter)

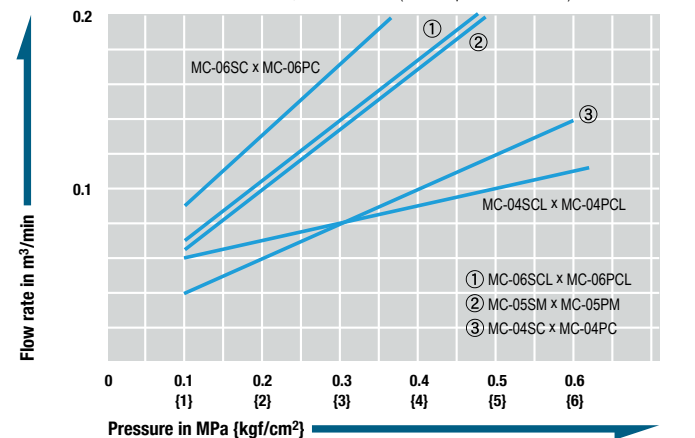

Models and Dimensions

**Plug PH type (Tube barb)**

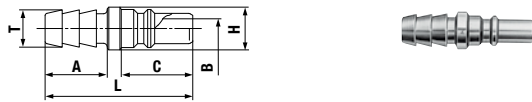

Model	Application (Tube)	Body material*Mass (g) Brass	Dimensions (mm)					
			L	C	A	øH	øT	øB
MC-03PH	3 mm ID	1.2	19	9.2	8	5.5	3.5	1.2
MC-04PH	4 mm ID	1.4	19	9.2	8	5.5	4.8	2.5

**Plug PM type (Male thread)**



Model	Application (Thread)	Body material*Mass (g) Brass	Dimensions (mm)					
			L	C	A	H(WAF)	T	øB
MC-05PM	M5 x 0.8	1.9	17	9.2	4.5	Hex.7	M5x0.8	2.5

**Plug PM type (Male thread)**



Model	Application (Thread)	Body material*Mass (g) Brass	Dimensions (mm)					
			L	C	H(WAF)	T	øB	
MC-10PM	Rc 1/8	9	26	9.2	Hex.11	R 1/8	2.5	

**Plug PHL type (Tube barb)**

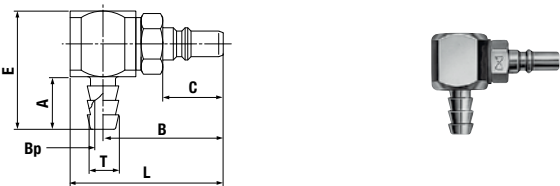

Model	Application (Tube)	Body material*Mass (g) Brass	Dimensions (mm)						
			L	C	A	B	E	øT	øBp
MC-04PHL	4 mm ID	9.4	(23.3)	9.2	8	(18.3)	18	4.8	2.5

Application Example

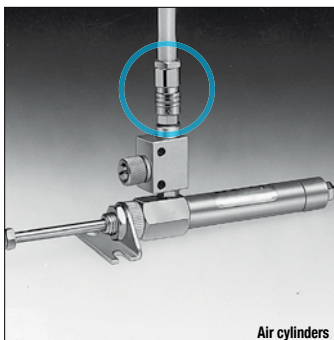

Air cylinders

Always fix tubes with hose clamps when using hose barb types.

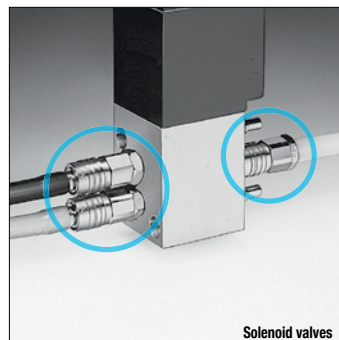

Solenoid valves

Always fix tubes with hose clamps when using hose barb types.

**Socket SH type (Tube barb)**

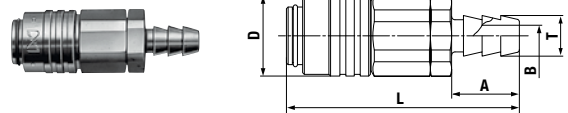

Model	Application (Tube)	Body material*Mass (g) Brass	Dimensions (mm)				
			L	øD	A	øT	øB
MC-03SH	3 mm ID	7	(27.5)	9.5	8	3.5	1.2
MC-04SH	4 mm ID	7.3	(27.5)	9.5	8	4.8	2.5

**Socket SM type (Male thread)**

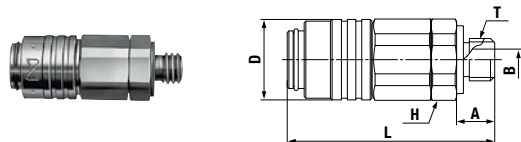

Model	Application (Thread)	Body material*Mass (g) Brass	Dimensions (mm)					
			L	øD	A	T	H(WAF)	øB
MC-05SM	M5 x 0.8	7.4	(24.5)	9.5	4.5	M5x0.8	Hex.9	2.5

**Socket SM type (Male thread)**

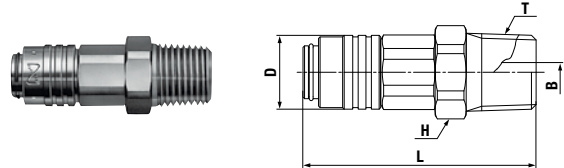

Model	Application (Thread)	Body material*Mass (g) Brass	Dimensions (mm)					
			L	øD	T	H(WAF)	øB	
MC-10SM	Rc 1/8	13.1	(30)	9.5	R 1/8	Hex.11	3	

**Socket SHL type (Tube barb)**

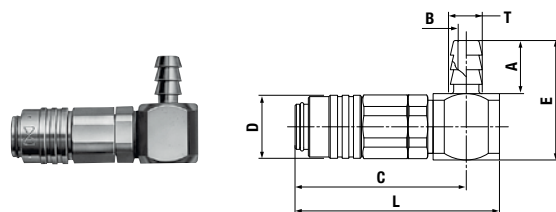

Model	Application (Tube)	Body material*Mass (g) Brass	Dimensions (mm)						
			L	C	E	A	øD	øT	øB
MC-04SHL	4 mm ID	14.8	(30.8)	(25.8)	18	8	9.5	4.8	2.5

**Socket SHB type (For panel mounting)**

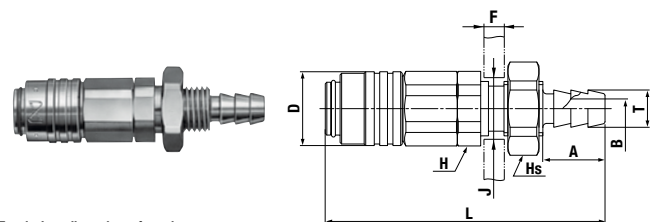

\* F and øJ are dimensions of panel.

Model	Application (Tube)	Body material*Mass (g) Brass	Dimensions (mm)								
			L	A	øD	øT	øB	Hs(WAF)	øJ	H(WAF)	F
MC-04SHB	4 mm ID	11.5	(36)	8	9.5	4.8	2.5	Hex.11	7.1 <sup>+0.3</sup> <sub>0</sub>	Hex.9	1.2 to 3.5

Models and Dimensions (MICRO CUPLA with Tube Fitter)

WAF : WAF stands for width across flats.

**Plug** PC type (With Tube Fitter)



Model	Application (Tube)	Mass (g)	Dimensions (mm)			
			L	C	øT	øB
MC-04PC	4 mm OD	3	(21.7)	9.2	8	2.5
MC-06PC	6 mm OD	5	(25)	9.2	9.8	2.5

**Socket** SC type (With Tube Fitter)

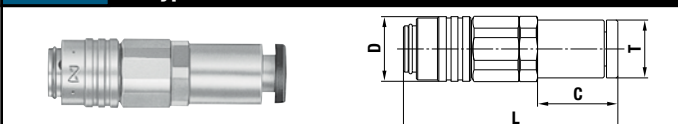

Model	Application (Tube)	Mass (g)	Dimensions (mm)			
			L	øD	C	øT
MC-04SC	4 mm OD	9	(31.5)	9.5	(11.8)	8
MC-06SC	6 mm OD	11.5	(33.5)	9.5	(12.5)	9.8

**Plug** PCL type (With L-shaped Tube Fitter)

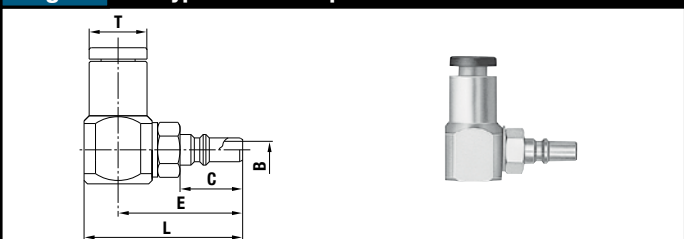

Model	Application (Tube)	Mass (g)	Dimensions (mm)				
			L	C	E	øT	øB
MC-04PCL	4 mm OD	10	(23.3)	9.2	(18.3)	8	2.5
MC-06PCL	6 mm OD	13.5	(24.3)	9.2	(18.8)	9.8	2.5

**Socket** SCL type (With L-shaped Tube Fitter)

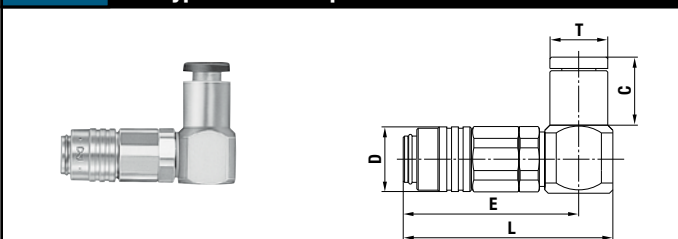

Model	Application (Tube)	Mass (g)	Dimensions (mm)				
			L	E	øD	C	øT
MC-04SCL	4 mm OD	16	(30.8)	(25.8)	9.5	(10)	8
MC-06SCL	6 mm OD	19	(31.8)	(26.3)	9.5	(12.5)	9.8

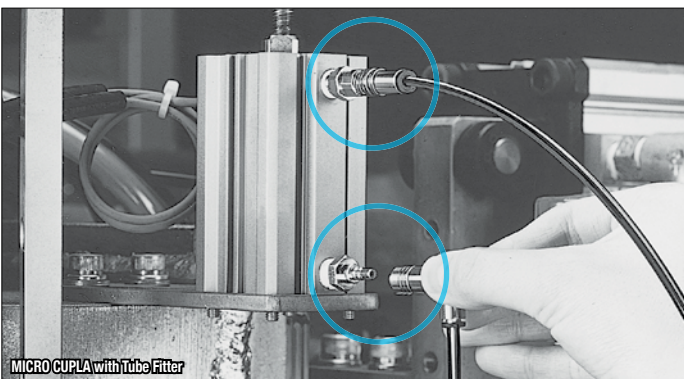

**Socket** SCB type (With Tube Fitter for panel mounting)

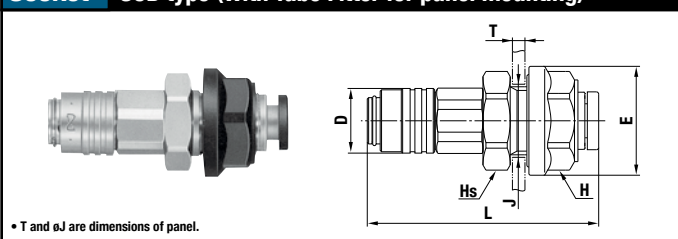

• T and øJ are dimensions of panel.

Model	Application (Tube)	Mass (g)	Dimensions (mm)						
			L	øD	øE	Hs(WAF)	H(WAF)	T	øJ
MC-04SCB	4 mm OD	15	(34)	9.5	16	Hex.13	Hex.13	3.5 or less	10.5 <sup>+0.3</sup> <sub>0</sub>
MC-06SCB	6 mm OD	18.5	(36)	9.5	18	Hex.15	Hex.15	3.5 or less	12.5 <sup>+0.3</sup> <sub>0</sub>

Models and Dimensions (MICRO LINE CUPLA)

WAF : WAF stands for width across flats.

**Socket** MC-03 type (MICRO LINE CUPLA with three branch ports)

Mass: 65 g  
• The branch body is made of aluminum alloy.

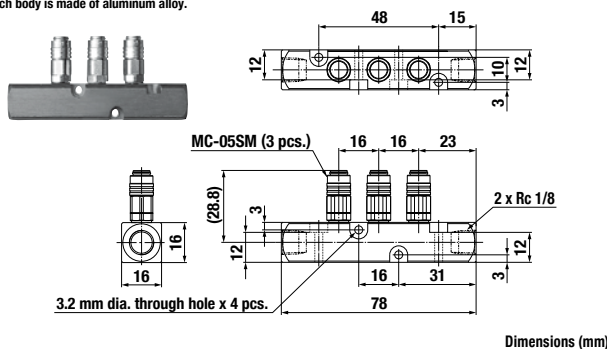

**Socket** MC-05 type (MICRO LINE CUPLA with 5 branch ports)

Mass: 101 g  
• The branch body is made of aluminum alloy.

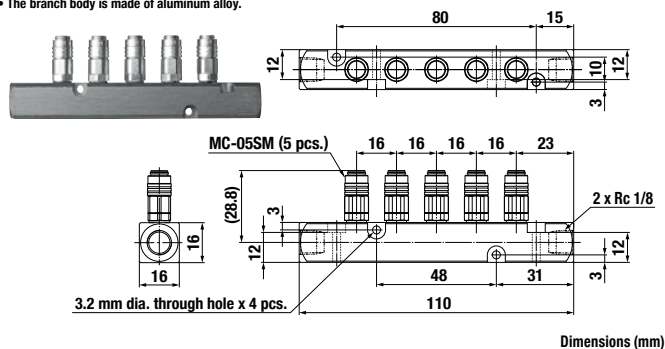

**Socket** MC-10 type (MICRO LINE CUPLA with 10 branch ports)

Mass: 187 g  
• The branch body is made of aluminum alloy.

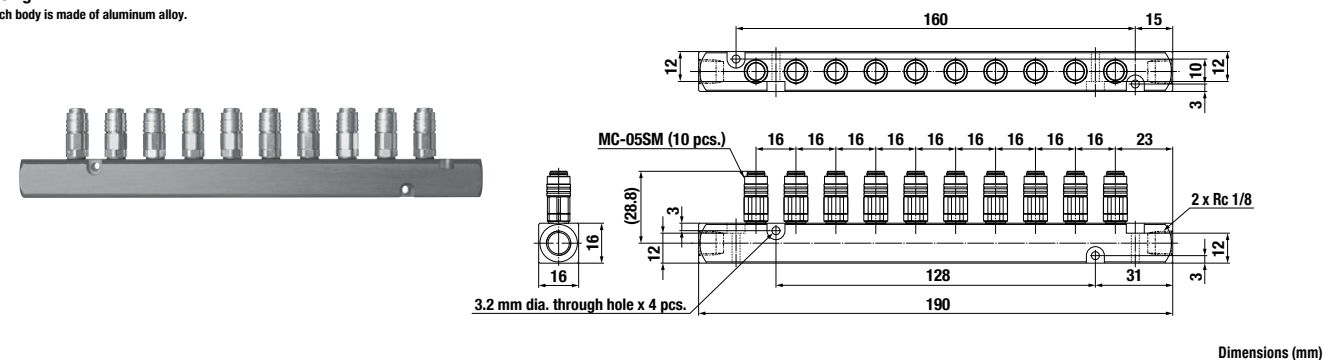

# MICRO CUPLA

## Stainless Steel Models

### Highly Corrosion-resistant Stainless Steel MICRO CUPLA

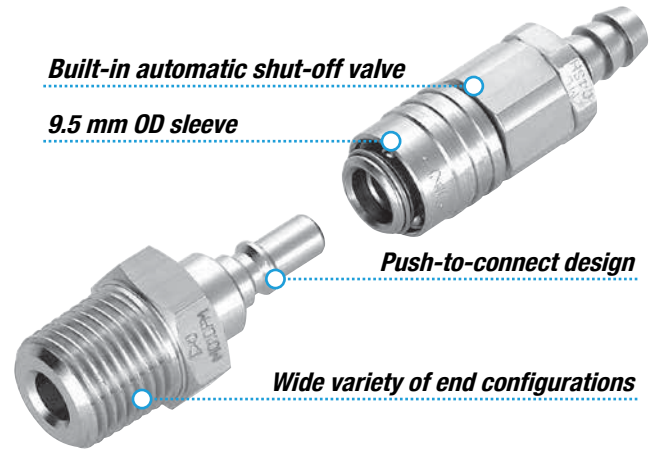

#### Models and Dimensions (Stainless Steel)

WAF: WAF stands for width across flats.

#### Plug PH type (Hose barb)

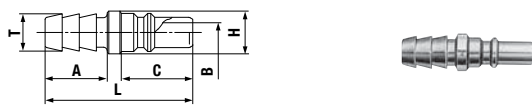

Model	Application (Tube)	Body material* Mass (g)	Dimensions (mm)					
		Stainless steel	L	C	A	øH	øT	øB
MC-04PH	4 mm ID	1.3	19	9.2	8	5.5	4.8	2.5

#### Plug PM type (Male thread)



Model	Application (Thread)	Body material* Mass (g)	Dimensions (mm)					
		Stainless steel	L	C	A	H(WAF)	T	øB
MC-05PM	M5 x 0.8	2.2	17	9.2	4.5	Hex.8	M5x0.8	2.5

#### Plug PM type (Male thread)



Model	Application (Thread)	Body material* Mass (g)	Dimensions (mm)					
		Stainless steel	L	C	H(WAF)	T	øB	
MC-10PM	Rc 1/8	8.1	26	9.2	Hex.11	R 1/8	2.5	

#### Plug PHL type (Hose barb)

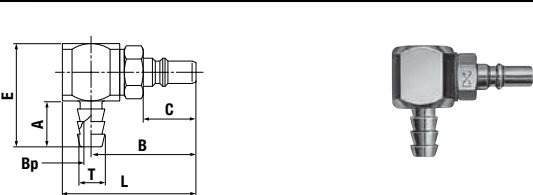

Model	Application (Tube)	Body material* Mass (g)	Dimensions (mm)						
		Stainless steel	L	C	A	B	E	øT	øBp
MC-04PHL	4 mm ID	9	(23.3)	9.2	8	(18.3)	18	4.8	2.5

#### Socket SH type (Hose barb)

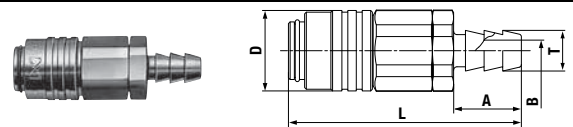

Model	Application (Tube)	Body material* Mass (g)	Dimensions (mm)				
		Stainless steel	L	øD	A	øT	øB
MC-04SH	4 mm ID	6.7	(27.5)	9.5	8	4.8	2.5

#### Socket SM type (Male thread)

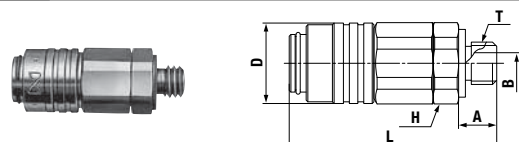

Model	Application (Thread)	Body material* Mass (g)	Dimensions (mm)					
		Stainless steel	L	øD	A	T	H(WAF)	øB
MC-05SM	M5 x 0.8	6.8	(24.5)	9.5	4.5	M5x0.8	Hex.9	2.5

#### Socket SM type (Male thread)

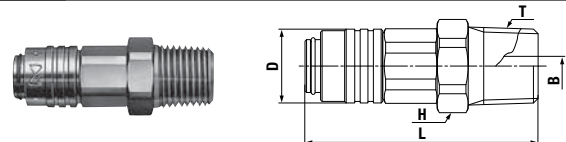

Model	Application (Thread)	Body material* Mass (g)	Dimensions (mm)					
		Stainless steel	L	øD	T	H(WAF)	øB	
MC-10SM	Rc 1/8	12.1	(30)	9.5	R 1/8	Hex.11	3	

#### Socket SHL type (Hose barb)

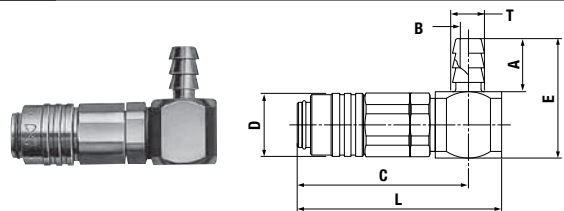

Model	Application (Tube)	Body material* Mass (g)	Dimensions (mm)						
		Stainless steel	L	C	E	A	øD	øT	øB
MC-04SHL	4 mm ID	13.6	(30.8)	(25.8)	18	8	9.5	4.8	2.5

#### Socket SHB type (For panel mounting)

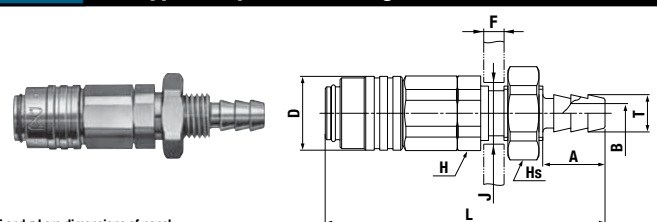

\* F and øJ are dimensions of panel.

Model	Application (Tube)	Body material* Mass (g)	Dimensions (mm)									
		Stainless steel	L	A	øD	øT	øB	H(WAF)	øJ	H(WAF)	F	
MC-04SHB	4 mm ID	10.6	(36)	8	9.5	4.8	2.5	Hex.11	7.1 <sup>+0.3</sup> <sub>0</sub>	Hex.9	1.2 to 3.5	





Before use, please be sure to read "Safety Guide" described at the end of this book and "Instruction Sheet" that comes with the products.



For Low Pressure

# SMALL CUPLA

Lightweight and compact for use on air lines and scientific equipment

<b>Working pressure</b>	<b>Valve structure</b>	<b>Applicable fluids</b>	
 1.0 MPa (10 kgf/cm <sup>2</sup> )	 One-way shut-off	 Air	 Water (Tube Fitter type is unsuitable for water.)

Lightweight and compact push-to-connect operation.  
Responding to requirements of modular combinations.

- Compact socket with built-in valve and 14 mm OD sleeve. Suits applications calling for compact and modular components.
- Just push in the plug to the socket for connection by easy one hand operation.
- Plated brass for corrosion resistance adopted for the body. Stable performance for long life.
- A wide line-up of end configurations (female and male threads, hose barb, manifolds) enables suitability with a wide range of piping applications such as pneumatic, scientific and medical equipment.
- Also available with quick connect/disconnect Tube Fitter type.

Note: Fluid will flow out from the plug side when disconnected. Take necessary precaution if the fluid is water.

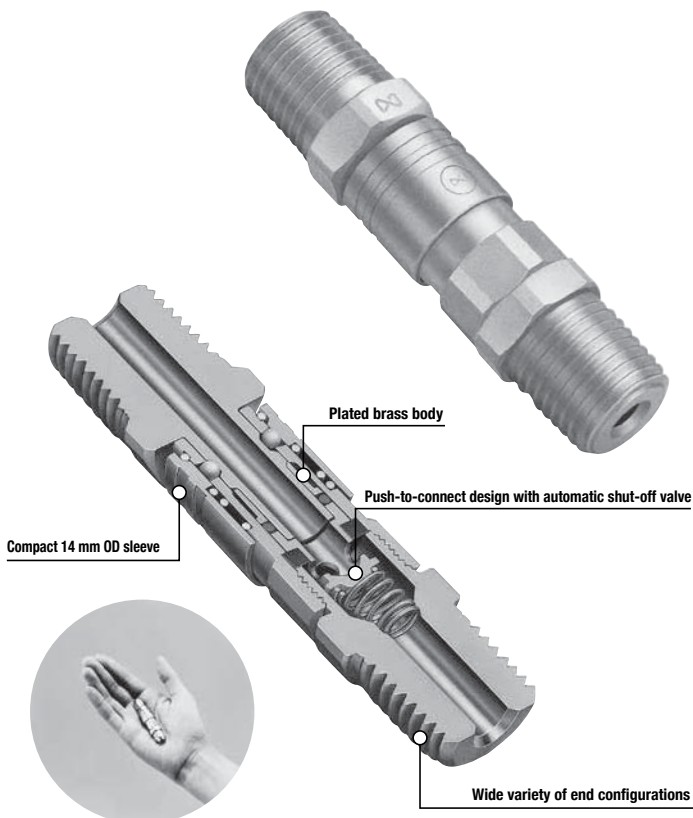

## Specifications

<b>Body material</b>	CUPLA : Brass (Chrome plated) Tube Fitter Part : Brass (Nickel plated) , Plastic			
<b>Size</b>	<b>Thread</b>	1/8", 1/4"		
	<b>Hose barb</b>	Polyamide hose: $\phi 4 \times \phi 6$ , $\phi 4.5 \times \phi 6$ Urethane hose: $\phi 4 \times \phi 6$		
	<b>Tube barb (Tube fitter)</b>	Polyurethane tube: Outside Dia. $\phi 6 \pm 0.1$ , $\phi 8 \pm 0.15$ Polyamide tube: Outside Dia. $\phi 6^{+0.05}_{-0.08}$ , $\phi 8^{+0.05}_{-0.1}$ Fluorine contained resin tube: Outside Dia. $\phi 6 \pm 0.07$ , $\phi 8 \pm 0.07$		
<b>Pressure unit</b>	<b>MPa</b>	<b>kgf/cm<sup>2</sup></b>	<b>bar</b>	<b>PSI</b>
<b>Working pressure</b>	1.0	10	10	145
<b>Seal material</b>	<b>Seal material</b>	<b>Mark</b>	<b>Working temperature range</b>	<b>Remarks</b>
	Nitrile rubber	NBR (SG)	-20°C to +80°C	Standard material

\* Above specifications apply only to CUPLA. Maximum working pressure and working temperature range may vary depending on tube materials you use with and the working temperature.

## Maximum Tightening Torque Nm {kgf·cm}

<b>Size (Thread)</b>	<b>1/8"</b>	<b>1/4"</b>	<b>PN · SN Type</b>
<b>Torque</b>	5 {51}	9 {92}	5 {51}

## Flow Direction

Fluid flow can be bi-directional when socket and plug are connected.

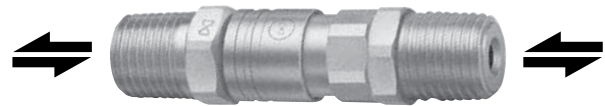

## Interchangeability

Sockets and plugs can be connected regardless of end configurations.

## Minimum Cross-Sectional Area (mm<sup>2</sup>)

Model	MS-10SM x MS-10PM	MS-20SM x MS-20PM	MS-40SN x MS-40PN	MS-45SN x MS-45PN	Tube Fitter Type for 6 mm OD tube	Tube Fitter Type for 8 mm OD tube
Minimum cross-sectional area	12.5	12.5	4.9	7	12.5	12.5

## Suitability for Vacuum 53.0 kPa {400 mmHg}

<b>Socket only</b>	<b>Plug only</b>	<b>When connected</b>
—	—	Operational

## Pressure - Flow Characteristics

[Test conditions] • Fluid : Air • Temperature : Room temperature  
• Tube size :  $\phi 6$  mm x  $\phi 4$  mm,  $\phi 8$  mm x  $\phi 6$  mm (SMALL CUPLA with Tube Fitter)

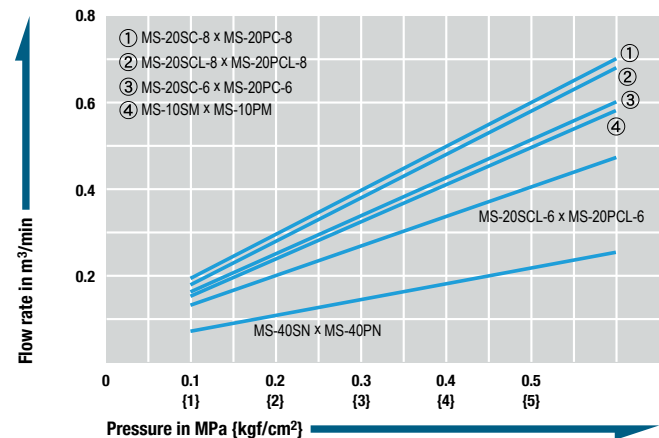

Models and Dimensions

**Plug PN type (For connection to hose)**

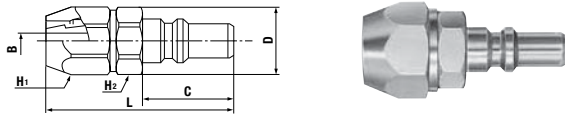

Model	Application (Hose)	Mass (g)	Dimensions (mm)					
			L	C	øD	H1(WAF)	H2(WAF)	øB
MS-40PN	ø4 mm x ø6 mm Polyamide	10.5	(31)	15.2	11	Hex.10	Hex.10	2.5
MS-45PN	ø4.5 mm x ø6 mm Polyamide ø4 mm x ø6 mm Polyurethane	11	(31)	15.2	11	Hex.10	Hex.10	3

**Plug PM type (Male thread)**

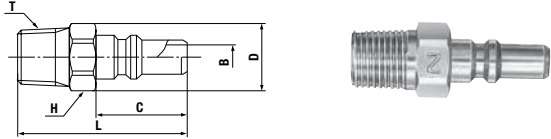

Model	Application (Thread)	Mass (g)	Dimensions (mm)					
			L	øD	C	H(WAF)	T	øB
MS-10PM	Rc 1/8	9	28.5	12	15.2	Hex.11	R 1/8	4
MS-20PM	Rc 1/4	19.5	32.5	15.2	15.2	Hex.14	R 1/4	4

**Plug PF type (Female thread)**

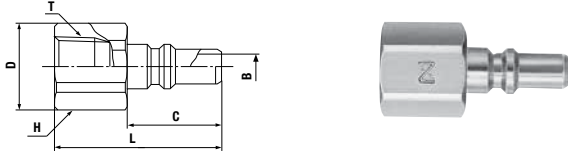

Model	Application (Thread)	Mass (g)	Dimensions (mm)					
			L	øD	C	H(WAF)	T	øB
MS-10PF	R 1/8	11	27	14	15.2	Hex.13	Rc 1/8	4

**Plug PC type (Tube Fitter)**

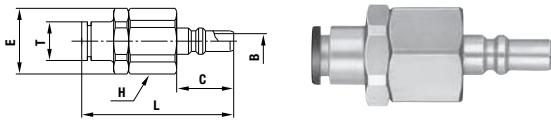

Model	Application (Tube)	Mass (g)	Dimensions (mm)					
			L	C	øE	H(WAF)	øT	øB
MS-20PC-6	6 mm OD	26.5	(40.5)	15.2	17.5	Hex.16	10.3	4
MS-20PC-8	8 mm OD	31	(47.5)	15.2	17.5	Hex.16	13.5	4

**Plug PCL type (L-shaped Tube Fitter)**

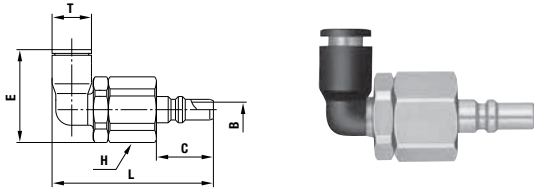

Model	Application (Tube)	Mass (g)	Dimensions (mm)					
			L	C	E	H(WAF)	øT	øB
MS-20PCL-6	6 mm OD	27.5	(43)	15.2	(24.8)	Hex.16	10.5	4
MS-20PCL-8	8 mm OD	32	(46.5)	15.2	(31.8)	Hex.16	13.5	4

**Socket MS-5 type (SMALL LINE CUPLA with 5 branch ports)**

• The branch body is made of aluminum alloy.

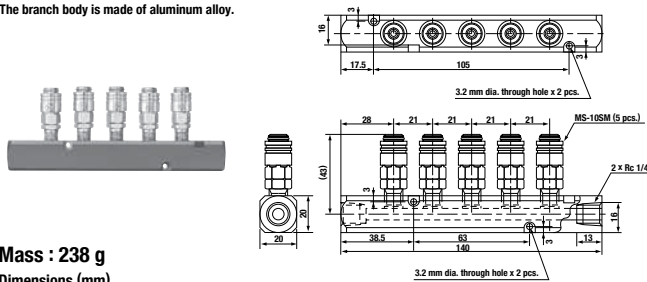

Mass : 238 g  
Dimensions (mm)

**Socket SN type (For connection to hose)**

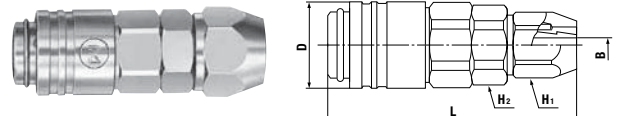

Model	Application (Hose)	Mass (g)	Dimensions (mm)				
			L	H1(WAF)	H2(WAF)	øD	øB
MS-40SN	ø4 mm x ø6 mm Polyamide	26.5	(40.8)	Hex.10	Hex.12	14	2.5
MS-45SN	ø4.5 mm x ø6 mm Polyamide ø4 mm x ø6 mm Polyurethane	27.0	(40.8)	Hex.10	Hex.12	14	3

**Socket SM type (Male thread)**

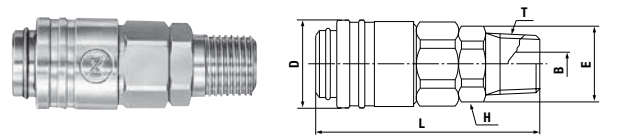

Model	Application (Thread)	Mass (g)	Dimensions (mm)					
			L	H(WAF)	T	øD	øE	øB
MS-10SM	Rc 1/8	24	(36.8)	Hex.12	R 1/8	14	13.2	4
MS-20SM	Rc 1/4	34	(40.8)	Hex.14	R 1/4	14	15.2	4

**Socket SF type (Female thread)**

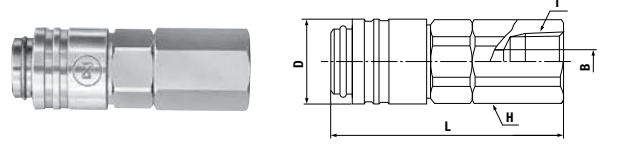

Model	Application (Thread)	Mass (g)	Dimensions (mm)				
			L	H(WAF)	T	øD	øB
MS-10SF	R 1/8	29.5	(38.8)	Hex.13	Rc 1/8	14	4

**Socket SC type (Tube Fitter)**

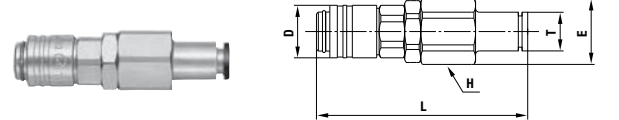

Model	Application (Tube)	Mass (g)	Dimensions (mm)				
			L	øD	øE	H(WAF)	øT
MS-20SC-6	6 mm OD	46	(56.3)	14	17.5	Hex.16	10.3
MS-20SC-8	8 mm OD	50.5	(60.8)	14	17.5	Hex.16	13.5

**Socket SCL type (L-shaped Tube Fitter)**

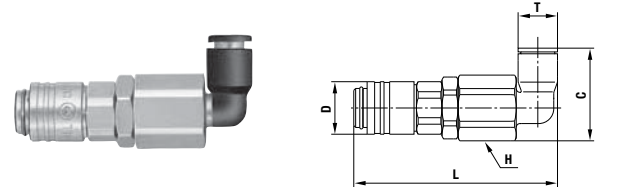

Model	Application (Tube)	Mass (g)	Dimensions (mm)				
			L	øD	C	H(WAF)	øT
MS-20SCL-6	6 mm OD	47.5	(56.8)	14	(24.8)	Hex.16	10.5
MS-20SCL-8	8 mm OD	49.5	(59.8)	14	(31.8)	Hex.16	13.5

**Socket SCB type (Tube Fitter for panel mounting)**

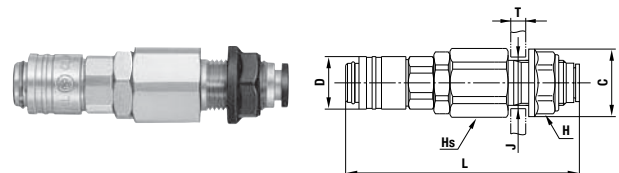

• T and øJ are dimensions of panel.

Model	Application (Tube)	Mass (g)	Dimensions (mm)						
			L	øD	øC	Hs(WAF)	H(WAF)	T	øJ
MS-20SCB-6	6 mm OD	57.5	(61.3)	14	18	Hex.17	Hex.15	7 or less	12.5 <sup>+0.3</sup> <sub>0</sub>
MS-20SCB-8	8 mm OD	58.5	(62.8)	14	21	Hex.17	Hex.18	8 or less	15.5 <sup>+0.3</sup> <sub>0</sub>

For Low Pressure

# COMPACT CUPLA

Small multipurpose type for low pressure lines

Working pressure



Valve structure



Applicable fluids



Compact 17.5 mm outer diameter, yet socket and plug have built-in automatic shut-off valves.

- Both socket and plug have built-in automatic shut-off valves.
- Compact size with maximum outer diameter 17.5 mm.
- For small bore piping from temperature control piping to scientific equipment.
- Body materials in stainless steel (SUS304) or brass, excellent in corrosion resistance.
- Four types of end configuration enable suitability with a wide range of piping applications.



## Specifications

Body material		Brass, Stainless steel (SUS 304)			
Size	Thread	1/8"			
	Tube barb	Polyamide tube : $\phi 4 \times \phi 6, \phi 6 \times \phi 8$ Polyolefin tube : $\phi 4 \times \phi 6, \phi 6 \times \phi 8$ Fluorine contained resin tube : $\phi 4 \times \phi 6, \phi 6 \times \phi 8$			
Pressure unit	MPa	kgf/cm <sup>2</sup>	bar	PSI	
Working pressure	1.0	10	10	145	
Seal material	Seal material	Mark	Working temperature range	Remarks	
	Working temperature range	Fluoro rubber	FKM	-20°C to +180°C	Standard material
		Ethylene-propylene rubber	EPDM	-40°C to +150°C	Available on request

Note: Maximum working pressure and working temperature range of nut type depend on the tube material and its dimensional tolerance.

## Maximum Tightening Torque

Nm {kgf·cm}

Size (Thread)	1/8"		Tube barb
Torque	Brass	5 {51}	5 {51}
	Stainless steel	9 {92}	7 {71}

## Flow Direction

Fluid flow can be bi-directional when socket and plug are connected.



## Interchangeability

Sockets and plugs can be connected regardless of end configurations.

## Minimum Cross-Sectional Area

(mm<sup>2</sup>)

Model	CO-1SM x CO-1PM	CO-1SF x CO-1PF	CO-40SN x CO-40PN	CO-60SN x CO-60PN
Minimum cross-sectional area	8.8	8.8	4.9	8.8

## Suitability for Vacuum

$1.3 \times 10^{-1}$  Pa { $1 \times 10^{-3}$  mmHg}

Socket only	Plug only	When connected
—	—	Operational

## Admixture of Air on Connection

May vary depending upon the usage conditions. (mL)

Volume of air admixture	0.34
-------------------------	------

## Volume of Spillage per Disconnection

May vary depending upon the usage conditions. (mL)

Volume of spillage	0.23
--------------------	------

## Flow Rate – Pressure Loss Characteristics

[Test conditions] • Fluid : Water • Temperature : 20°C±5°C

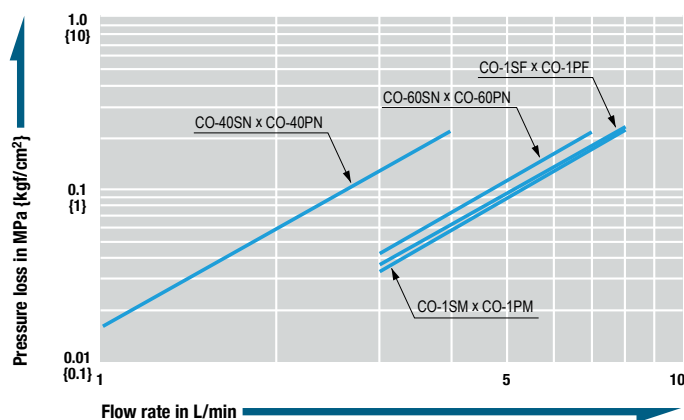

Models and Dimensions

**Plug PM type (Male thread)**

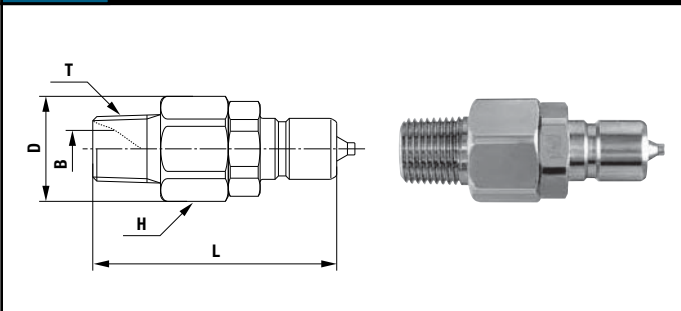

Model	Application (Thread)	Body material, Mass (g)		Dimensions (mm)				
		Brass	Stainless steel	L	øD	H (WAF)	T	øB
CO-1PM	Rc 1/8	20	19	(36)	15.5	Hex.14	R 1/8	5.5

**Socket SM type (Male thread)**

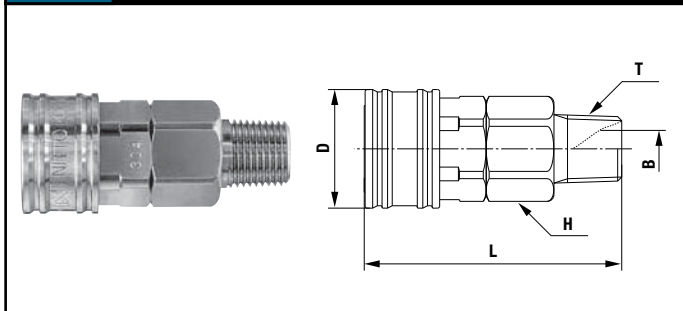

Model	Application (Thread)	Body material, Mass (g)		Dimensions (mm)				
		Brass	Stainless steel	L	øD	H (WAF)	T	øB
CO-1SM	Rc 1/8	34	32	(38)	17.5	Hex.14	R 1/8	5.5

**Plug PF type (Female thread)**

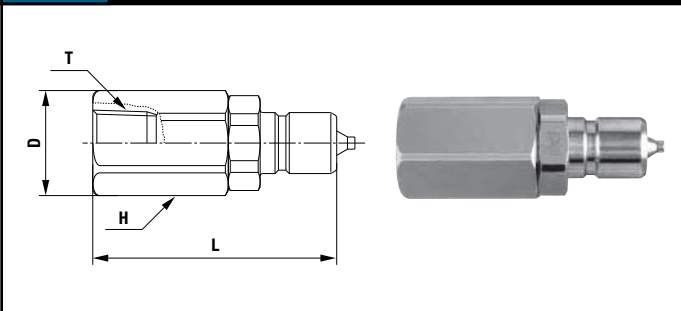

Model	Application (Thread)	Body material, Mass (g)		Dimensions (mm)			
		Brass	Stainless steel	L	øD	H (WAF)	T
CO-1PF	R 1/8	25	23	(36)	15.5	Hex.14	Rc 1/8

**Socket SF type (Female thread)**

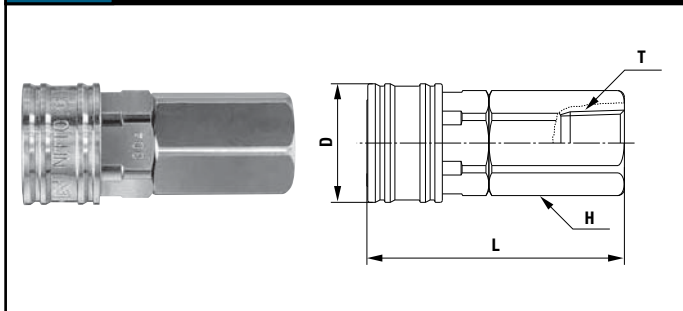

Model	Application (Thread)	Body material, Mass (g)		Dimensions (mm)			
		Brass	Stainless steel	L	øD	H (WAF)	T
CO-1SF	R 1/8	39	36	(38)	17.5	Hex.14	Rc 1/8

**Plug PN type (For connection to tube)**

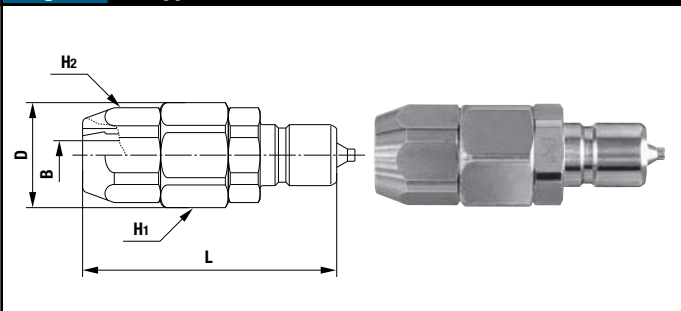

Model	Application (Tube)	Body material, Mass (g)		Dimensions (mm)				
		Brass	Stainless steel	L	øD	H1 (WAF)	H2 (WAF)	øB
CO-40PN	ø4 x ø6	23	22	(38.5)	15.5	Hex.14	Hex.10	2.5
CO-60PN	ø6 x ø8	25	24	(37.5)	15.5	Hex.14	Hex.13	4.2

**Socket SN type (For connection to tube)**

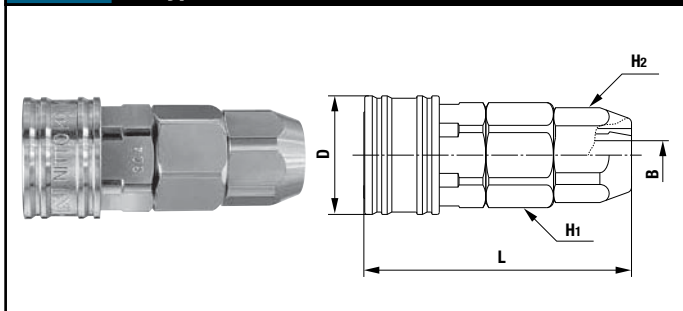

Model	Application (Tube)	Body material, Mass (g)		Dimensions (mm)				
		Brass	Stainless steel	L	øD	H1 (WAF)	H2 (WAF)	øB
CO-40SN	ø4 x ø6	38	35	(40.5)	17.5	Hex.14	Hex.10	2.5
CO-60SN	ø6 x ø8	40	37	(39.5)	17.5	Hex.14	Hex.13	4.2

No difference in dimensions of brass and stainless steel CUPLA

Application Example

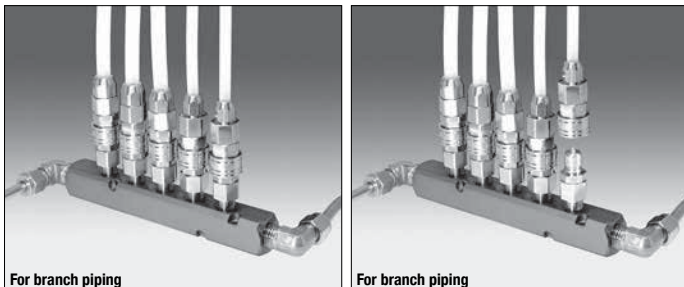

For branch piping

For branch piping

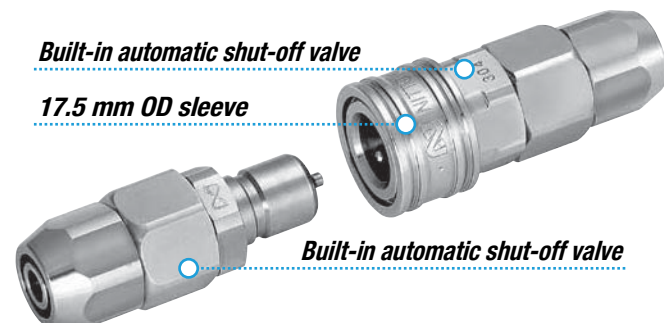



For Low Pressure

# CUBE CUPLA

Small and lightweight coupling for air supply lines.

Working pressure: **1.0** (1.0 MPa (10 kgf/cm<sup>2</sup>))

Valve structure: Two-way shut-off, One-way shut-off, Straight through

Applicable fluids: Air, Water

Both socket and plug have built-in valve types and valveless types. Simple one action for connection or disconnection. Lightweight plastic coupling.

- In all five color variations to prevent piping mistakes.
- Ultra-lightweight, made of polyacetal resin. Compact design for space saving.
- Just push plug into socket for connection. Simply press the button on the socket for disconnection.
- Two-way shut-off type with valve on both sides and straight through type with low pressure loss are available.
- L type plug ideal for piping in narrow spaces are available.
- Socket and plug cannot be disconnected unless two buttons on the socket are pressed simultaneously.



Choose from 5 colors

- Blue
- Yellow
- Pink
- Green
- Ivory

See page 3 for the colors

Push the buttons for quick disconnection

Push button for disconnection

Simple operation to push the buttons on the socket.

## Specifications

Body material	Polyacetal resin (POM)			
Size	4 mm and 6 mm ID tube, 1/8"			
Pressure unit	MPa	kgf/cm <sup>2</sup>	bar	PSI
Working pressure	1.0	10	10	145
Seal material	Seal material	Mark	Working temperature range	Remarks
Working temperature range	Nitrile rubber	NBR (SG)	-20°C to +60°C	Standard material

## Tightening Torque Range

Nm {kgf·cm}

Size (Thread)	R 1/8
Torque	0.9 to 1.1 {9.2 to 11}

## Flow Direction

Fluid flow can be bi-directional when socket and plug are connected.



## Interchangeability

Sockets and plugs can be connected regardless of end configurations. \*Do not use in the combination of valved sockets and valveless plugs. The valve in the socket will not open and the fluid will not flow.

## Connection capability

Select the combination of models suitable to your applications

Connection capability	Plug	
	With	Without
Socket	With	Two-way shut-off
	Without	One-way shut-off

Note: When disconnected, the fluid from the valveless side will flow out. Take care if the fluid is water.

## Minimum Cross-Sectional Area (-VL means Valve less type) (mm<sup>2</sup>)

Model Plug / Socket	SPC-04SH	SPC-06SH	SPC-10SM	SPC-04SH -VL	SPC-06SH -VL	SPC-10SM -VL
SPC-04PH/PHB/PHL	5	5	5	5	5	5
SPC-06PH/PHB/PHL	5	8.6	8.6	5	8.6	8.6
SPC-10PM	5	8.6	8.6	5	8.6	8.6
SPC-04PH-VL/PHB-VL/PHL-VL	-	-	-	5	5	5
SPC-06PH-VL/PHB-VL	-	-	-	5	10.2	10.2
SPC-06PHL-VL	-	-	-	5	10.2	12.6
SPC-10PM-VL	-	-	-	5	10.2	16.6

## Suitability for Vacuum

53.0 kPa {400 mmHg}

Socket only	Plug only	When connected
-	-	Operational

## Admixture of Air on Connection

May vary depending upon the usage conditions. (mL)

Volume of air admixture	0.60 (Built-in valve type only)
-------------------------	---------------------------------

## Volume of Spillage per Disconnection

May vary depending upon the usage conditions. (mL)

Volume of spillage	0.51 (Built-in valve type only)
--------------------	---------------------------------

## Pressure - Flow Characteristics (The fluid flow will not differ by body color)

[Test conditions] •Fluid : Air •Temperature : Room temperature

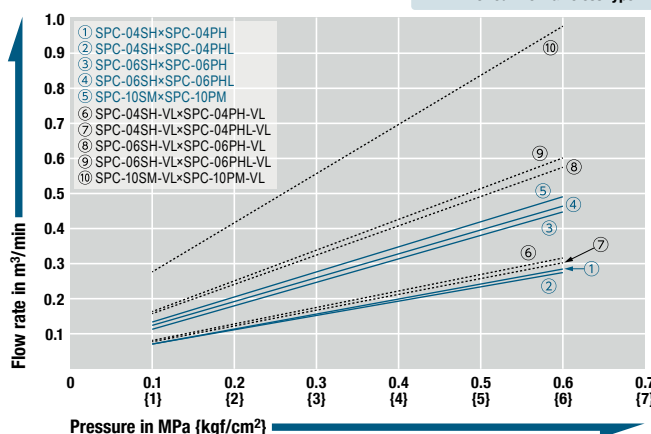



**Plug PH type (Hose barb)**

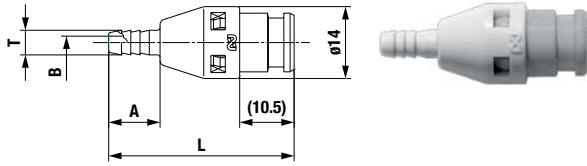

Color	Model	Application (Tube)	Built-in valve	Mass (g)	Dimensions (mm)			
					L	A	øT	øB
Ivory	SPC-04PH-IVR	4 mm ID	With	3.1	(36)	10	4.8	2.5
	SPC-04PH-VL-IVR	4 mm ID	Without	2.6	(36)	10	4.8	2.5
	SPC-06PH-IVR	6 mm ID	With	3.4	(40)	15	7	3.6
	SPC-06PH-VL-IVR	6 mm ID	Without	2.9	(40)	15	7	3.6
Blue	SPC-04PH-BLU	4 mm ID	With	3.1	(36)	10	4.8	2.5
	SPC-04PH-VL-BLU	4 mm ID	Without	2.6	(36)	10	4.8	2.5
	SPC-06PH-BLU	6 mm ID	With	3.4	(40)	15	7	3.6
	SPC-06PH-VL-BLU	6 mm ID	Without	2.9	(40)	15	7	3.6
Yellow	SPC-04PH-YEL	4 mm ID	With	3.1	(36)	10	4.8	2.5
	SPC-04PH-VL-YEL	4 mm ID	Without	2.6	(36)	10	4.8	2.5
	SPC-06PH-YEL	6 mm ID	With	3.4	(40)	15	7	3.6
	SPC-06PH-VL-YEL	6 mm ID	Without	2.9	(40)	15	7	3.6
Pink	SPC-04PH-PNK	4 mm ID	With	3.1	(36)	10	4.8	2.5
	SPC-04PH-VL-PNK	4 mm ID	Without	2.6	(36)	10	4.8	2.5
	SPC-06PH-PNK	6 mm ID	With	3.4	(40)	15	7	3.6
	SPC-06PH-VL-PNK	6 mm ID	Without	2.9	(40)	15	7	3.6
Green	SPC-04PH-GRN	4 mm ID	With	3.1	(36)	10	4.8	2.5
	SPC-04PH-VL-GRN	4 mm ID	Without	2.6	(36)	10	4.8	2.5
	SPC-06PH-GRN	6 mm ID	With	3.4	(40)	15	7	3.6
	SPC-06PH-VL-GRN	6 mm ID	Without	2.9	(40)	15	7	3.6

**Socket SH type (Hose barb)**

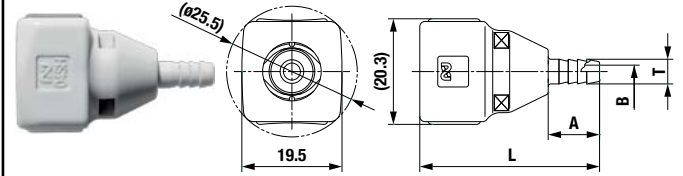

Color	Model	Application (Tube)	Built-in valve	Mass (g)	Dimensions (mm)			
					L	A	øT	øB
Ivory	SPC-04SH-IVR	4 mm ID	With	6.5	35	10	4.8	2.5
	SPC-04SH-VL-IVR	4 mm ID	Without	6.1	35	10	4.8	2.5
	SPC-06SH-IVR	6 mm ID	With	7.0	40	15	7	3.6
	SPC-06SH-VL-IVR	6 mm ID	Without	6.6	40	15	7	3.6
Blue	SPC-04SH-BLU	4 mm ID	With	6.5	35	10	4.8	2.5
	SPC-04SH-VL-BLU	4 mm ID	Without	6.1	35	10	4.8	2.5
	SPC-06SH-BLU	6 mm ID	With	7.0	40	15	7	3.6
	SPC-06SH-VL-BLU	6 mm ID	Without	6.6	40	15	7	3.6
Yellow	SPC-04SH-YEL	4 mm ID	With	6.5	35	10	4.8	2.5
	SPC-04SH-VL-YEL	4 mm ID	Without	6.1	35	10	4.8	2.5
	SPC-06SH-YEL	6 mm ID	With	7.0	40	15	7	3.6
	SPC-06SH-VL-YEL	6 mm ID	Without	6.6	40	15	7	3.6
Pink	SPC-04SH-PNK	4 mm ID	With	6.5	35	10	4.8	2.5
	SPC-04SH-VL-PNK	4 mm ID	Without	6.1	35	10	4.8	2.5
	SPC-06SH-PNK	6 mm ID	With	7.0	40	15	7	3.6
	SPC-06SH-VL-PNK	6 mm ID	Without	6.6	40	15	7	3.6
Green	SPC-04SH-GRN	4 mm ID	With	6.5	35	10	4.8	2.5
	SPC-04SH-VL-GRN	4 mm ID	Without	6.1	35	10	4.8	2.5
	SPC-06SH-GRN	6 mm ID	With	7.0	40	15	7	3.6
	SPC-06SH-VL-GRN	6 mm ID	Without	6.6	40	15	7	3.6

**Plug PM type (Male thread)**

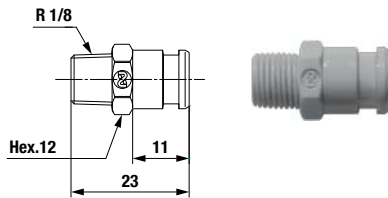

Dimensions (mm)

Color	Model	Application (Thread)	Built-in valve	Mass (g)
Ivory	SPC-10PM-IVR	Rc 1/8	With	2.0
	SPC-10PM-VL-IVR	Rc 1/8	Without	1.5
Blue	SPC-10PM-BLU	Rc 1/8	With	2.0
	SPC-10PM-VL-BLU	Rc 1/8	Without	1.5
Yellow	SPC-10PM-YEL	Rc 1/8	With	2.0
	SPC-10PM-VL-YEL	Rc 1/8	Without	1.5
Pink	SPC-10PM-PNK	Rc 1/8	With	2.0
	SPC-10PM-VL-PNK	Rc 1/8	Without	1.5
Green	SPC-10PM-GRN	Rc 1/8	With	2.0
	SPC-10PM-VL-GRN	Rc 1/8	Without	1.5

**Socket SM type (Male thread)**

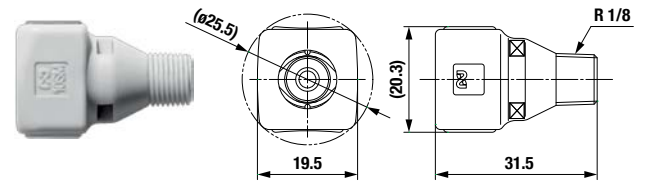

Dimensions (mm)

Color	Model	Application (Thread)	Built-in valve	Mass (g)
Ivory	SPC-10SM-IVR	Rc 1/8	With	6.8
	SPC-10SM-VL-IVR	Rc 1/8	Without	6.4
Blue	SPC-10SM-BLU	Rc 1/8	With	6.8
	SPC-10SM-VL-BLU	Rc 1/8	Without	6.4
Yellow	SPC-10SM-YEL	Rc 1/8	With	6.8
	SPC-10SM-VL-YEL	Rc 1/8	Without	6.4
Pink	SPC-10SM-PNK	Rc 1/8	With	6.8
	SPC-10SM-VL-PNK	Rc 1/8	Without	6.4
Green	SPC-10SM-GRN	Rc 1/8	With	6.8
	SPC-10SM-VL-GRN	Rc 1/8	Without	6.4

**Plug PHB Type (For panel mount)**

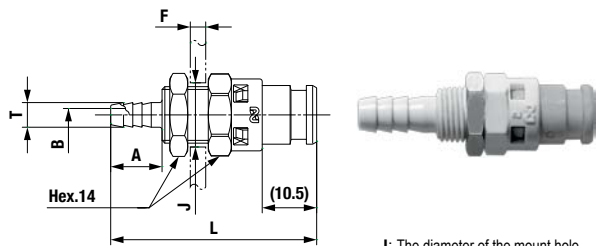

J: The diameter of the mount hole.  
F: Thickness of panel must be 5 mm or less.

Color	Model	Application (Tube)	Built-in valve	Mass (g)	Dimensions (mm)					
					L	A	øT	øB	F	øJ
Ivory	SPC-04PHB-IVR	4 mm ID	With	5.9	(40)	10	4.8	2.5	5 mm or less	11.1 <sup>+0.3</sup> <sub>0</sub>
	SPC-04PHB-VL-IVR	4 mm ID	Without	5.4	(40)	10	4.8	2.5	5 mm or less	11.1 <sup>+0.3</sup> <sub>0</sub>
	SPC-06PHB-IVR	6 mm ID	With	6.2	(45)	15	7	3.6	5 mm or less	11.1 <sup>+0.3</sup> <sub>0</sub>
	SPC-06PHB-VL-IVR	6 mm ID	Without	5.7	(45)	15	7	3.6	5 mm or less	11.1 <sup>+0.3</sup> <sub>0</sub>
Blue	SPC-04PHB-BLU	4 mm ID	With	5.9	(40)	10	4.8	2.5	5 mm or less	11.1 <sup>+0.3</sup> <sub>0</sub>
	SPC-04PHB-VL-BLU	4 mm ID	Without	5.4	(40)	10	4.8	2.5	5 mm or less	11.1 <sup>+0.3</sup> <sub>0</sub>
	SPC-06PHB-BLU	6 mm ID	With	6.2	(45)	15	7	3.6	5 mm or less	11.1 <sup>+0.3</sup> <sub>0</sub>
	SPC-06PHB-VL-BLU	6 mm ID	Without	5.7	(45)	15	7	3.6	5 mm or less	11.1 <sup>+0.3</sup> <sub>0</sub>
Yellow	SPC-04PHB-YEL	4 mm ID	With	5.9	(40)	10	4.8	2.5	5 mm or less	11.1 <sup>+0.3</sup> <sub>0</sub>
	SPC-04PHB-VL-YEL	4 mm ID	Without	5.4	(40)	10	4.8	2.5	5 mm or less	11.1 <sup>+0.3</sup> <sub>0</sub>
	SPC-06PHB-YEL	6 mm ID	With	6.2	(45)	15	7	3.6	5 mm or less	11.1 <sup>+0.3</sup> <sub>0</sub>
	SPC-06PHB-VL-YEL	6 mm ID	Without	5.7	(45)	15	7	3.6	5 mm or less	11.1 <sup>+0.3</sup> <sub>0</sub>
Pink	SPC-04PHB-PNK	4 mm ID	With	5.9	(40)	10	4.8	2.5	5 mm or less	11.1 <sup>+0.3</sup> <sub>0</sub>
	SPC-04PHB-VL-PNK	4 mm ID	Without	5.4	(40)	10	4.8	2.5	5 mm or less	11.1 <sup>+0.3</sup> <sub>0</sub>
	SPC-06PHB-PNK	6 mm ID	With	6.2	(45)	15	7	3.6	5 mm or less	11.1 <sup>+0.3</sup> <sub>0</sub>
	SPC-06PHB-VL-PNK	6 mm ID	Without	5.7	(45)	15	7	3.6	5 mm or less	11.1 <sup>+0.3</sup> <sub>0</sub>
Green	SPC-04PHB-GRN	4 mm ID	With	5.9	(40)	10	4.8	2.5	5 mm or less	11.1 <sup>+0.3</sup> <sub>0</sub>
	SPC-04PHB-VL-GRN	4 mm ID	Without	5.4	(40)	10	4.8	2.5	5 mm or less	11.1 <sup>+0.3</sup> <sub>0</sub>
	SPC-06PHB-GRN	6 mm ID	With	6.2	(45)	15	7	3.6	5 mm or less	11.1 <sup>+0.3</sup> <sub>0</sub>
	SPC-06PHB-VL-GRN	6 mm ID	Without	5.7	(45)	15	7	3.6	5 mm or less	11.1 <sup>+0.3</sup> <sub>0</sub>

**Plug PHL Type (Hose barb)**

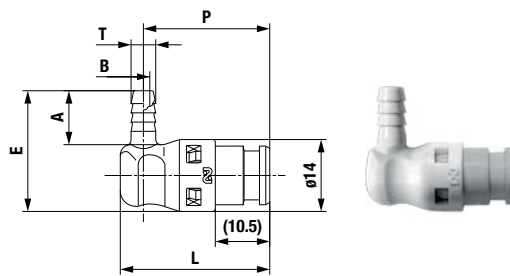

Color	Model	Application (Tube)	Built-in valve	Mass (g)	Dimensions (mm)					
					L	P	A	E	øT	øB
Ivory	SPC-04PHL-IVR	4 mm ID	With	3.5	(29)	(24.5)	10.5	23.5	4.8	2.5
	SPC-04PHL-VL-IVR	4 mm ID	Without	3	(29)	(24.5)	10.5	23.5	4.8	2.5
	SPC-06PHL-IVR	6 mm ID	With	3.9	(30.5)	(25.5)	15.5	28.5	7	4
	SPC-06PHL-VL-IVR	6 mm ID	Without	3.4	(30.5)	(25.5)	15.5	28.5	7	4
Blue	SPC-04PHL-BLU	4 mm ID	With	3.5	(29)	(24.5)	10.5	23.5	4.8	2.5
	SPC-04PHL-VL-BLU	4 mm ID	Without	3	(29)	(24.5)	10.5	23.5	4.8	2.5
	SPC-06PHL-BLU	6 mm ID	With	3.9	(30.5)	(25.5)	15.5	28.5	7	4
	SPC-06PHL-VL-BLU	6 mm ID	Without	3.4	(30.5)	(25.5)	15.5	28.5	7	4
Yellow	SPC-04PHL-YEL	4 mm ID	With	3.5	(29)	(24.5)	10.5	23.5	4.8	2.5
	SPC-04PHL-VL-YEL	4 mm ID	Without	3	(29)	(24.5)	10.5	23.5	4.8	2.5
	SPC-06PHL-YEL	6 mm ID	With	3.9	(30.5)	(25.5)	15.5	28.5	7	4
	SPC-06PHL-VL-YEL	6 mm ID	Without	3.4	(30.5)	(25.5)	15.5	28.5	7	4
Pink	SPC-04PHL-PNK	4 mm ID	With	3.5	(29)	(24.5)	10.5	23.5	4.8	2.5
	SPC-04PHL-VL-PNK	4 mm ID	Without	3	(29)	(24.5)	10.5	23.5	4.8	2.5
	SPC-06PHL-PNK	6 mm ID	With	3.9	(30.5)	(25.5)	15.5	28.5	7	4
	SPC-06PHL-VL-PNK	6 mm ID	Without	3.4	(30.5)	(25.5)	15.5	28.5	7	4
Green	SPC-04PHL-GRN	4 mm ID	With	3.5	(29)	(24.5)	10.5	23.5	4.8	2.5
	SPC-04PHL-VL-GRN	4 mm ID	Without	3	(29)	(24.5)	10.5	23.5	4.8	2.5
	SPC-06PHL-GRN	6 mm ID	With	3.9	(30.5)	(25.5)	15.5	28.5	7	4
	SPC-06PHL-VL-GRN	6 mm ID	Without	3.4	(30.5)	(25.5)	15.5	28.5	7	4

Choose from 5 colors

- Blue
- Yellow
- Pink
- Green
- Ivory

The following   part shown below are colored. The other plastic parts are ivory.

[See page 3 for the colors](#)

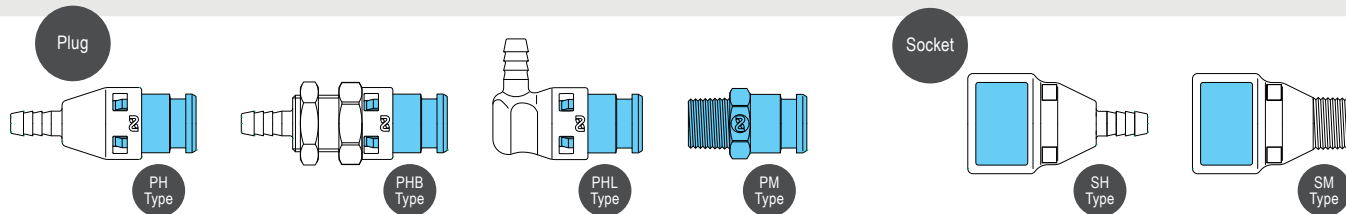

- Resin (POM) such as the main body ... Conforms to article No.3-D-2-(2)-2 and has passed both material and elution tests specified in the Food sanitation Act and the standards For Food and Food additives (Notice No. 370 of 1959 issued by the Ministry of Health and Welfare of Japan).
- O-ring (NBR) ... Conforms to article No.3-D-3-(1) and has passed both material and elution tests specified in the Food sanitation Act and the standards For Food and Food additives (Notice No. 370 of 1959 issued by the Ministry of Health and Welfare of Japan).
- Silicone type grease (NSF H1, NSF 61 registered product) is applied to the sealing material.
- The CUPLA should be evaluated before use to determine the suitability with applications that require sanitation control.

Small size

Lightweight  
made of resin

### Compared with products of the same specification

(Our products with similar working pressure / flow rate)



The weight is about ...

1/5

Push-to-connect  
operation

Push in

A clicking  
sound

Push button  
easy  
disconnection

Push button  
for disconnection  
2 places on the  
socket side

Just push  
the buttons

Push button  
easy  
disconnection

Before use, please be sure to read "Safety Guide" described at the end of this book and "Instruction Sheet" that comes with the products.

For Low Pressure (Air)

# SUPER CUPLA

Light, compact for air piping connections

Working pressure <b>1.0</b> 1.0 MPa (10 kgf/cm <sup>2</sup> )	Valve structure  One-way shut-off	Applicable fluid  Air
--	---	-----------------------------

## The lightweight design makes the CUPLA best suited to power tools! Push-to-connect for easy operation.

- Lightweight design suits direct connection to power tools. Aluminum body is adopted for some models to reduce the weight.
- Just push the plug into socket for easy one hand connection.
- Available in various end configurations for a wide range of pneumatic applications.
- Model 02S20P can be connected with sockets of HI CUPLA Models 10, 17, 20, 30 and 40.
- Also available with quick connect / disconnect Tube Fitter type.

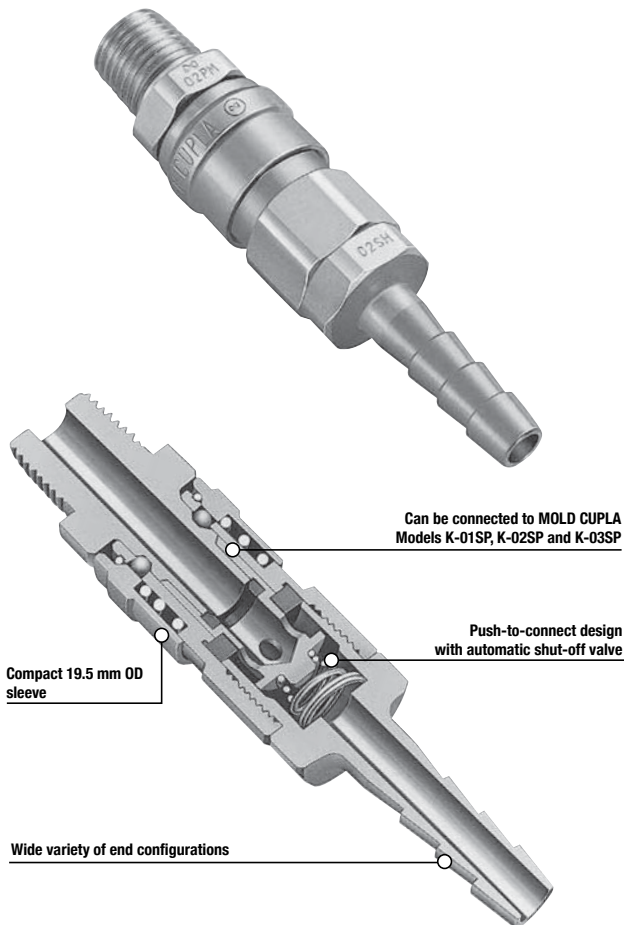

Specifications				
Body material	CUPLA : Steel (Chrome plated), Aluminum alloy (*1) Tube Fitter Part : Brass (Nickel plated) , Plastic			
	Thread	1/8", 1/4"		
Size	Hose barb	1/4", Urethane hose : $\phi 5 \times \phi 8$ , $\phi 6.5 \times \phi 10$		
	Tube barb (Tube fitter)	Polyurethane tube: Outside Dia. $\phi 6 \pm 0.1$ , $\phi 8 \pm 0.15$ Polyamide tube: Outside Dia. $\phi 6^{+0.05}_{-0.08}$ , $\phi 8^{+0.05}_{-0.1}$ Fluorine contained resin tube: Outside Dia. $\phi 6 \pm 0.07$ , $\phi 8 \pm 0.07$		
Pressure unit	MPa	kgf/cm <sup>2</sup>	bar	PSI
Working pressure	1.0	10	10	145
Seal material	Seal material	Mark	Working temperature range	Remarks
Working temperature range	Nitrile rubber	NBR (SG)	-20°C to +80°C	Standard material

\* Above specifications apply only to CUPLA. Maximum working pressure and working temperature range may vary depending on tube materials you use with and the working temperature.  
CUPLA with Tube Fitter has NBR packing material only.  
(\*1) Aluminum alloy is used for the body of 01SN, 02SN, 02SMF, 02SC-6, 02SC-8, 02SCL-6, 02SCL-8, 02SCB-6, 02SCB-8.

Maximum Tightening Torque		Nm {kgf·cm}
Size (Thread)	1/8"	1/4"
Torque	7 {71}	14 {143}

Tightening Torque Range		Nm {kgf·cm}
PN Type, SN Type		
		9 to 11 {92 to 112}

To mount on urethane hose, slide it over to the hose barb and tighten the nut until it is flush against the hose barb base. It is recommended that grease is applied to the inside of the nut (threaded part and hose contact part) for easy tightening.

### Flow Direction

Fluid flow can be bi-directional when socket and plug are connected.

### Interchangeability

Sockets and plugs can be connected regardless of end configurations and sizes.  
\*Interchangeable with MOLD CUPLA.  
\*Sockets of HI CUPLA models 10, 17, 20, 30, 40 can be connected when 02S20P is used.

Minimum Cross-Sectional Area		(mm <sup>2</sup> )					
Plug / Socket	01PN	02PC-6 / 02PCL-6	02PC-8 / 02PCL-8	02PH / 01PM	02PN	02PM / 02PFF	
	01SN	11.3	11.3	11.3	11.3	11.3	11.3
02SC-6/02SCL-6/02SCB-6	11.3	12.5	12.5	12.5	12.5	12.5	
02SC-8/02SCL-8/02SCB-8	11.3	12.5	19	19	19	19	
02SH	11.3	12.5	19	19.6	19.6	19.6	
02SN	11.3	12.5	19	19.6	22	22	
02SM/02SF/02SMF	11.3	12.5	19	19.6	22	28.2	
02S20P	11.3	12.5	19	19.6	22	28.2	

### Suitability for Vacuum

Not suitable for vacuum application in either connected or disconnected condition.

### Pressure - Flow Characteristics

[Test conditions] • Fluid : Air • Temperature : Room temperature  
• Tube size :  $\phi 6 \text{ mm} \times \phi 4 \text{ mm}$ ,  $\phi 8 \text{ mm} \times \phi 6 \text{ mm}$  (SUPER CUPLA with Tube Fitter)

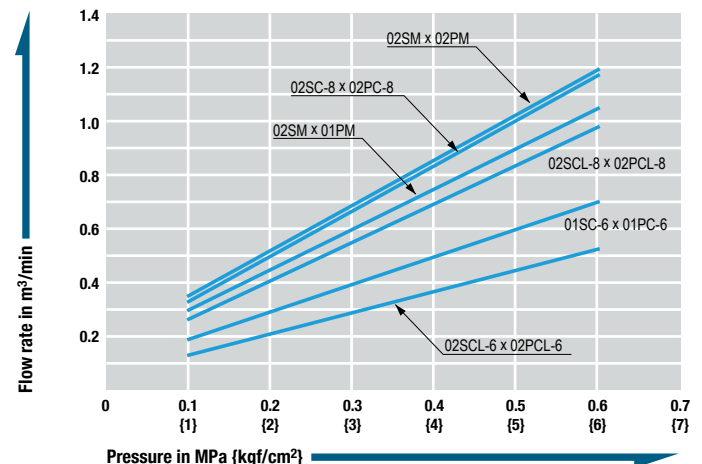

Models and Dimensions

**Plug** O2PH type (Hose barb)

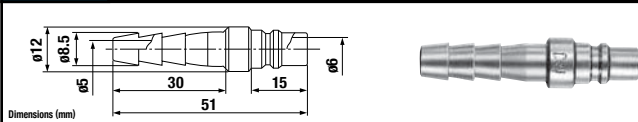

Model	Application (Hose)	Mass (g)
O2PH	1/4"	16

**Plug** PN type (For connection to urethane hose)

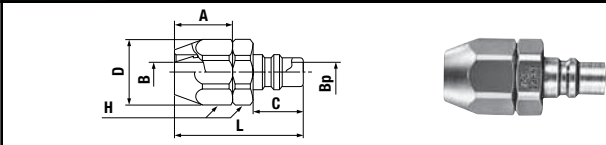

Model	Application (Hose)	Mass (g)	Dimensions (mm)						
			L	C	øD	A	H(WAF)	øBp	øB
O1PN	ø5 mm x ø8 mm	35.9	(38.5)	15	18.5	17	Hex.17	6	3.8
O2PN	ø6.5 mm x ø10 mm	35.3	(38.5)	15	18.5	17	Hex.17	6	5.3

**Plug** PM type (Male thread)

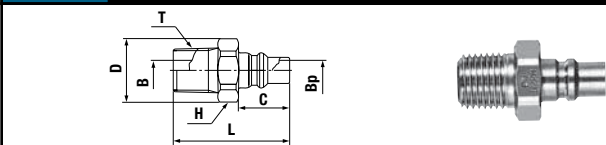

Model	Application (Thread)	Mass (g)	Dimensions (mm)						
			L	C	øD	H(WAF)	T	øBp	øB
O1PM	Rc 1/8	12	31	15	-	Hex.12	R 1/8	6	5
O2PM	Rc 1/4	22.7	34	15	18.5	Hex.17	R 1/4	6	6

**Plug** O2PFF type (Parallel female thread)

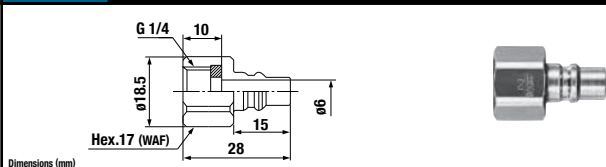

Model	Application (Thread)	Mass (g)
O2PFF	G 1/4	17.7

**Plug/Socket** Model O2S20P (Conversion model to connect HI CUPLA socket)

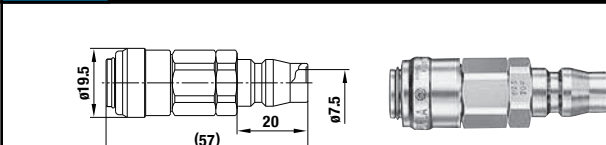

Model	Application	Mass (g)
O2S20P	HI CUPLA (Socket)	58

**Plug** PC type (With Tube Fitter)

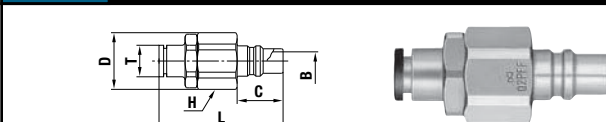

Model	Application (Tube)	Mass (g)	Dimensions (mm)						
			L	C	øD	E	H(WAF)	øT	øB
O2PC-6	6 mm OD	28.5	(40.5)	15	18.5	18.5	Hex.17	10.3	6
O2PC-8	8 mm OD	33	(47.5)	15	18.5	18.5	Hex.17	13.5	6

**Plug** PCL type (With L-shaped Tube Fitter)

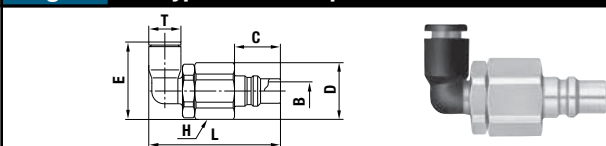

Model	Application (Tube)	Mass (g)	Dimensions (mm)						
			L	C	øD	E	H(WAF)	øT	øB
O2PCL-6	6 mm OD	29.5	(43)	15	18.5	(25.3)	Hex.17	10.5	6
O2PCL-8	8 mm OD	34.5	(46.5)	15	18.5	(32.3)	Hex.17	13.5	6

**Socket** O2SH type (Hose barb)

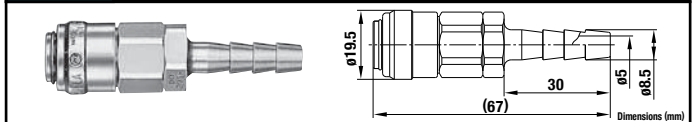

Model	Application (Hose)	Mass (g)
O2SH	1/4"	56

**Socket** SN type (For connection to urethane hose)

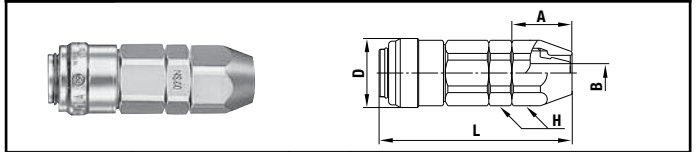

Model	Application (Hose)	Mass (g)	Dimensions (mm)				
			L	A	øD	H(WAF)	øB
O1SN	ø5 mm x ø8 mm	45.8	(54.5)	17	19.5	Hex.17	3.8
O2SN	ø6.5 mm x ø10 mm	44.4	(54.5)	17	19.5	Hex.17	5.3

**Socket** SM type (Male thread)

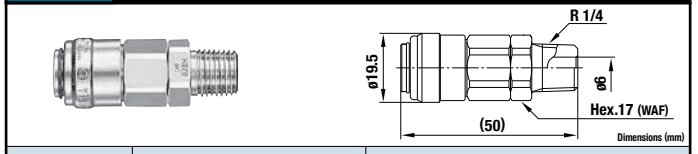

Model	Application (Thread)	Mass (g)
O2SM	Rc 1/4	57

**Socket** O2SF type (Female thread)

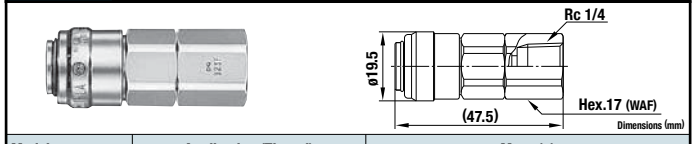

Model	Application (Thread)	Mass (g)
O2SF	R 1/4	56.4

**Socket** O2SMF type (Parallel male thread)

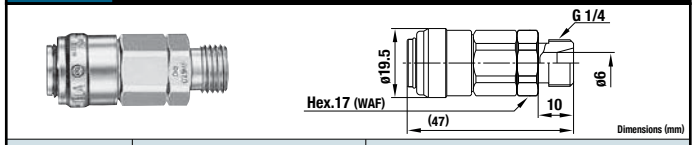

Model	Application (Thread)	Mass (g)
O2SMF	G 1/4	27

**Socket** SC type (With Tube Fitter)

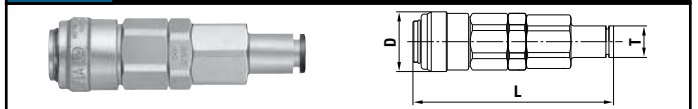

Model	Application (Tube)	Mass (g)	Dimensions (mm)		
			L	øD	øT
O2SC-6	6 mm OD	46	(65.5)	19.5	10.5
O2SC-8	8 mm OD	50.5	(70)	19.5	13.5

**Socket** SCL type (With L-shaped Tube Fitter)

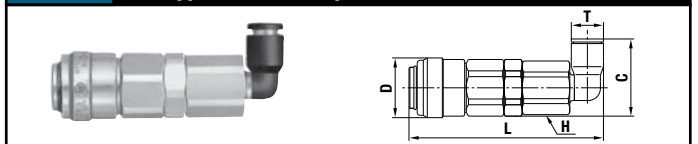

Model	Application (Tube)	Mass (g)	Dimensions (mm)				
			L	øD	H(WAF)	C	øT
O2SCL-6	6 mm OD	47.5	(63.5)	19.5	Hex.16	(25.7)	10.3
O2SCL-8	8 mm OD	49.5	(67.7)	19.5	Hex.16	(32.8)	13.5

**Socket** SCB type (With Tube Fitter for panel mounting)

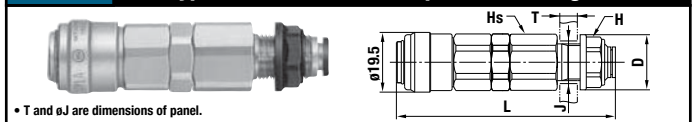

Model	Application (Tube)	Mass (g)	Dimensions (mm)					
			L	øD	Hs(WAF)	H(WAF)	T	øJ
O2SCB-6	6 mm OD	58.5	(71.5)	18	Hex.17	Hex.15	7 or less	12.5 <sup>+0.3</sup> <sub>0</sub>
O2SCB-8	8 mm OD	60.4	(72)	21	Hex.17	Hex.18	8 or less	15.5 <sup>+0.3</sup> <sub>0</sub>

\* T and øJ are dimensions of panel.



For Low Pressure

# HI CUPLA

Universal purpose couplings for air lines

Working pressure

Valve structure

Applicable fluids (Steel applies to air only)

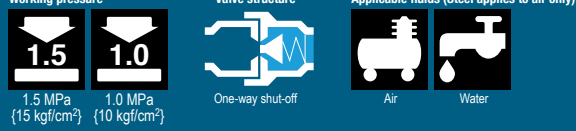

1.5 MPa (15 kgf/cm<sup>2</sup>)    1.0 MPa (10 kgf/cm<sup>2</sup>)

One-way shut-off

Air    Water

From factory air line to pneumatic tool connection, available in various body materials, sizes and end configurations. Excellent durability.

- An excellent general purpose coupling for connecting factory air supply to pneumatic tools.
- Steel coupling is suitable for air. Brass or stainless steel is suitable for water. Note that fluid will come out from the plug when disconnected.
- Critical structural parts of steel models are heat-treated for increased strength giving greater durability and resistance to wear.
- Available in various body materials, sizes and end configurations applicable to a wide range of applications.

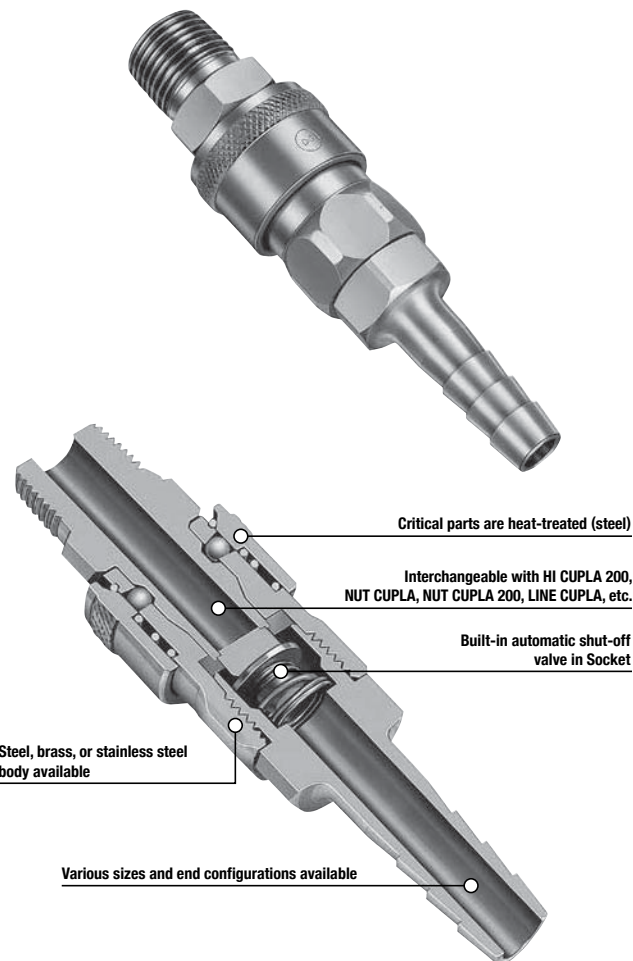

Specifications				
Body material		Steel (Chrome plated)	Brass	Stainless steel (SUS304)
Size	Thread	1/8" to 1"		
	Hose barb	1/4" to 1" hose		
Working pressure	MPa	1.5	1.0	1.5
	kgf/cm <sup>2</sup>	15	10	15
	bar	15	10	15
	PSI	218	145	218
Seal material		Nitrile rubber	Fluoro rubber	
Working temperature range		-20°C to +80°C	-20°C to +180°C	Standard material
		Mark	Working temperature range	Remarks
		NBR (SG)		
		FKM (X-100)		

Maximum Tightening Torque					Nm {kgf·cm}		
Size (Thread)		1/8"	1/4"	3/8"	1/2"	3/4"	1"
	Steel	7 {71}	14 {143}	22 {224}	60 {612}	100 {1020}	120 {1224}
Torque	Brass	5 {51}	9 {92}	11 {112}	30 {306}	50 {510}	65 {663}
	Stainless steel	—	14 {143}	22 {224}	60 {612}	100 {1020}	120 {1224}

**Flow Direction**

Fluid must run from socket to plug.



- Interchangeability**
- ① Sockets and plugs of models 10, 17, 20, 30, and 40 can be connected with each other regardless of end configurations.
  - ② Sockets and plugs of models 400, 600, and 800 can be connected with each other regardless of end configurations. ① and ② can not be connected across each group.
  - ③ Interchangeable with each models of NUT CUPLA series and HI CUPLA series. Please see page 19 for "HI CUPLA Series Interchangeability".

Minimum Cross-Sectional Area (mm <sup>2</sup> )											
■ 10, 17, 20, 30, 40 type											
Socket \ Plug	17PH	20PH	30PH	40PH	10PM	20PM	30PM	40PM	20PF	30PF	40PF
10SM	16	20	20	20	13	20	20	20	20	20	20
17SH	16	16	16	16	13	16	16	16	16	16	16
20SH	16	20	20	20	13	20	20	20	20	20	20
20SM, SF	16	20	33	33	13	33	33	33	33	33	33
30SH	16	20	33	33	13	33	33	33	33	33	33
30SM, SF	16	20	33	33	13	33	33	33	33	33	33
40SH	16	20	33	33	13	33	33	33	33	33	33
40SM, SF	16	20	33	33	13	33	33	33	33	33	33

■ 400, 600, 800 type										
Socket \ Plug	400PH	600PH	800PH	400PM	600PM	800PM	400PF	600PF	800PF	
400SH	64	64	64	64	64	64	64	64	64	
400SM, SF	64	94	94	94	94	94	94	94	94	
600SH	64	94	94	94	94	94	94	94	94	
600SM, SF	64	94	94	94	94	94	94	94	94	
800SH	64	94	94	94	94	94	94	94	94	
800SM, SF	64	94	94	94	94	94	94	94	94	

**Suitability for Vacuum**  
Not suitable for vacuum application in either connected or disconnected condition.

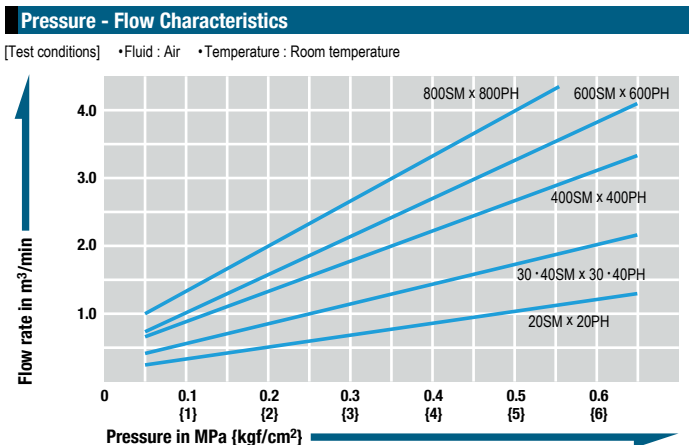

Models and Dimensions

WAF : WAF stands for width across flats.

**Plug PH type (Hose barb)**

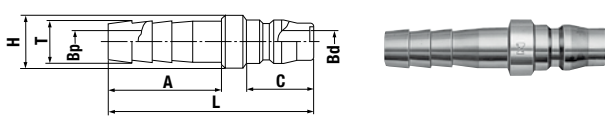

Model	Application (Hose)	Body material • Mass (g)			Dimensions (mm)						
		Steel	Brass	Stainless steel	L	øH	A	C	øT	øBp	øBd
17PH	1/4"	24	-	-	54	16	27	20	7.2	4.5	7.5
20PH	1/4"	28	31	27	57	16	30	20	9	5	7.5
30PH	3/8"	32	34	33	61	16	34	20	11.3	7.5	7.5
40PH	1/2"	59	64	60	63	20	36	20	15	9	7.5
400PH	1/2"	65	71	66	66	22	36	23	15	9	13
600PH	3/4"	123	130	124	77	30	45	23	21	13	13
800PH	1"	151	161	151	85	34	54	23	27	20	13

**Socket SH type (Hose barb)**

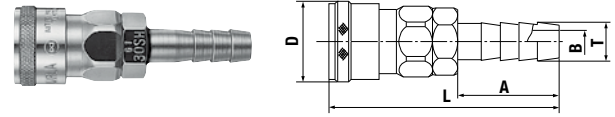

Model	Application (Hose)	Body material • Mass (g)			Dimensions (mm)				
		Steel	Brass	Stainless steel	L	øD	A	øT	øB
17SH	1/4"	99	-	-	(69.5)	(26.5)	27	7.2	4.5
20SH	1/4"	99	105	97	(72.5)	(26.5) <sup>+1</sup>	30	9	5
30SH	3/8"	102	107	100	(76.5)	(26.5) <sup>+1</sup>	34	11.3	7.5
40SH	1/2"	115	122	113	(78.5)	(26.5) <sup>+1</sup>	36	15	9
400SH	1/2"	220	235	230	(83)	35	36	15	9
600SH	3/4"	243	262	242	(92)	35	45	21	14
800SH	1"	327	350	325	(102)	35	55	27	16

**Plug PM type (Male thread)**

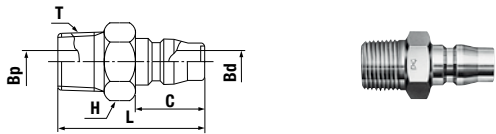

Model	Application (Thread)	Body material • Mass (g)			Dimensions (mm)					
		Steel	Brass	Stainless steel	L	H(WAF)	C	T	øBp	øBd
10PM	Rc 1/8	22	24	-	37	Hex.14	20	R 1/8	4	7.5
20PM	Rc 1/4	25	27	26	41	Hex.14	20	R 1/4	7.5	7.5
30PM	Rc 3/8	40	43	41	42	Hex.19 <sup>-3</sup>	20	R 3/8	7.5	7.5
40PM	Rc 1/2	60	65	60	46	Hex.22	20	R 1/2	12	7.5
400PM	Rc 1/2	70	73	69	50	Hex.22	23	R 1/2	13	13
600PM	Rc 3/4	113	121	114	55	Hex.32	23	R 3/4	19	13
800PM	Rc 1	182	196	183	63	Hex.35	23	R 1	22	13

**Socket SM type (Male thread)**

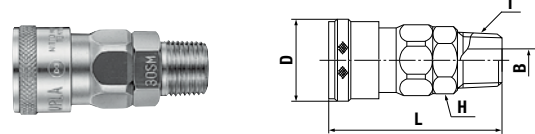

Model	Application (Thread)	Body material • Mass (g)			Dimensions (mm)				
		Steel	Brass	Stainless steel	L	øD	H(WAF)	T	øB
10SM	Rc 1/8	97	-	-	(52.5)	(26.5)	Hex.19	R 1/8	5
20SM	Rc 1/4	97	103	96	(55.5)	(26.5) <sup>+1</sup>	Hex.19	R 1/4	7
30SM	Rc 3/8	104	108	100	(56.5)	(26.5) <sup>+1</sup>	Hex.19	R 3/8	8 <sup>+4</sup>
40SM	Rc 1/2	127	135	126	(59.5)	(26.5) <sup>+1</sup>	Hex.23 <sup>+2</sup>	R 1/2	9
400SM	Rc 1/2	210	224	212	(63)	35	Hex.29	R 1/2	13
600SM	Rc 3/4	242	259	243	(67)	35	Hex.32	R 3/4	16
800SM	Rc 1	329	353	328	(72)	35	Hex.36	R 1	16

**Plug PF type (Female thread)**

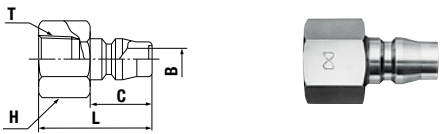

Model	Application (Thread)	Body material • Mass (g)			Dimensions (mm)				
		Steel	Brass	Stainless steel	L	H(WAF)	C	T	øB
20PF	R 1/4	28	31	29	36	Hex.17	20	Rc 1/4	7.5
30PF	R 3/8	35	41	38	37	Hex.21	20	Rc 3/8	7.5
40PF	R 1/2	69	76	70	38	Hex.29	20	Rc 1/2	7.5
400PF	R 1/2	82	86	81	41	Hex.29	23	Rc 1/2	13
600PF	R 3/4	115	124	115	45	Hex.35	23	Rc 3/4	13
800PF	R 1	189	207	190	54	Hex.41	23	Rc 1	13

**Socket SF type (Female thread)**

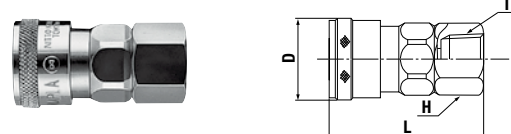

Model	Application (Thread)	Body material • Mass (g)			Dimensions (mm)			
		Steel	Brass	Stainless steel	L	øD	H(WAF)	T
20SF	R 1/4	97	101	94	(49.5)	(26.5) <sup>+1</sup>	Hex.19	Rc 1/4
30SF	R 3/8	98	103	95	(50.5)	(26.5) <sup>+1</sup>	Hex.21	Rc 3/8
40SF	R 1/2	136	146	138	(52.5)	(26.5) <sup>+1</sup>	Hex.29	Rc 1/2
400SF	R 1/2	216	233	215	(57)	35	Hex.29	Rc 1/2
600SF	R 3/4	259	277	257	(61)	35	Hex.35	Rc 3/4
800SF	R 1	327	361	327	(68)	35	Hex.41	Rc 1

**Plug PFF type (Parallel female thread)**

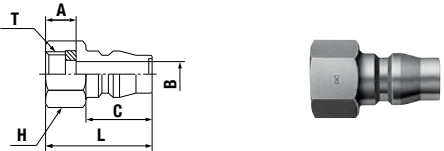

Model	Application (Thread)	Body material • Mass (g)			Dimensions (mm)					
		Steel	Brass	Stainless steel	L	H(WAF)	A	C	T	øB
20PFF	G 1/4	23	-	-	32	Hex.17	9	20	G 1/4	7.5

**Plug PC type (Tube Fitter)**

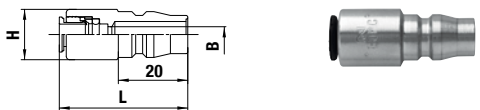

Model	Application (Tube)	Mass (g)	Dimensions (mm)		
			L	øH	øB
60PC	For 6 mm OD tube	25	(37)	14.5	4.5
80PC	For 8 mm OD tube	30	(41)	16.5	6.5
100PC	For 10 mm OD tube	43	(45)	19.5	7.5

\* Above pictures are plugs and sockets of steel 20, 30 and 40 models.

\*1 : D = 25.4 for brass and stainless steel models.

\*2 : H = Hex. 22 for brass and stainless steel models.

\*3 : H = Hex. 17 for brass and stainless steel models.

\*4 : B = 9 for brass and stainless steel models.

**Application Example**

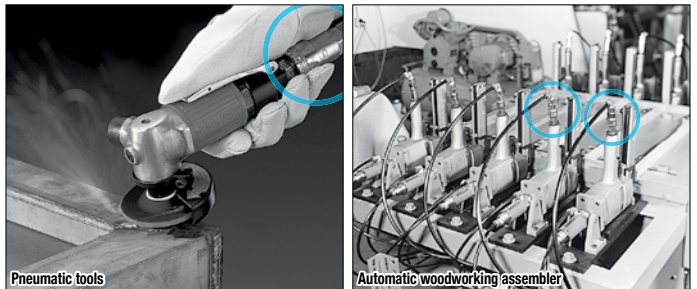

**All of socket, plug and tube can be connected in one push-to-connect operation.**

Just push the tube into CUPLA and then it is locked.

Polyurethane, Nylon and Fluorine contained resin tubes.

**PC type (Tube Fitter)**

For Low Pressure

# HI CUPLA BL

Universal purpose couplings with sleeve lock mechanism for air lines

Working pressure

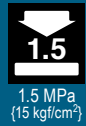

Valve structure



Applicable fluids (Steel applies to air only)

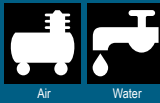

Sleeve-lock mechanism is engaged by rotating the sleeve after connection.

- Sleeve-lock mechanism prevents accidental disconnection.
- An excellent general purpose coupling for connecting factory air supply to pneumatic tools.
- Steel coupling is suitable for air. Stainless steel is suitable for water. Note that fluid will come out from the plug when disconnected.
- Critical structural parts made of steel are heat-treated for increased strength giving greater durability and resistance to wear.
- Various body materials, sizes, and end configurations are available.
- SN-BL type for connection to urethane hose requires no hose clamp.



Specifications					
Body material		Steel (Chrome plated)	Stainless steel (SUS304)		
Size	Thread and hose barb	1/4", 3/8", 1/2"			
	SN Type for urethane hose	For ø6.5 x ø10 mm hose	-		
		For ø8 x ø12 mm hose			
For ø8.5 x ø12.5 mm hose					
Pressure unit		MPa	kgf/cm <sup>2</sup>	bar	PSI
Working pressure		1.5	15	15	218
Seal material		Seal material	Mark	Working temperature range	Remarks
Working temperature range		Nitrile rubber	NBR (SG)	-20 °C to +80 °C	Standard material

Note: Working temperature range of SN-BL type is -20°C to +60°C.

Maximum Tightening Torque			Nm {kgf·cm}	
Size (Thread)	1/4"	3/8"	1/2"	
Torque	Steel	14 {143}	22 {224}	60 {612}
	Stainless steel	14 {143}	22 {224}	60 {612}

Tightening Torque Range		Nm {kgf·cm}	
SN Type for urethane hose			
9 to 11 {92 to 112}			

To mount on urethane hose, slide it over to the hose barb and tighten the nut until it is flush against the hose barb base. It is recommended that grease is applied to the inside of the nut (threaded part and hose contact part) for easy tightening.

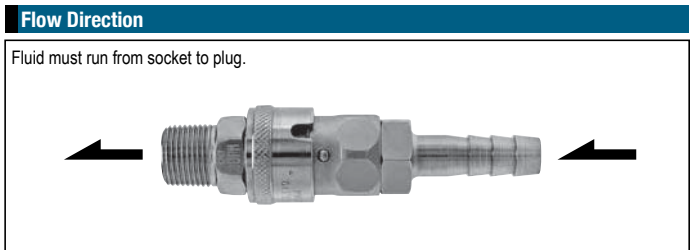

- Interchangeability**
- 1 Sockets and plugs of models 10, 17, 20, 30, and 40 can be connected with each other regardless of end configurations.
  - 2 Interchangeable with each models of NUT CUPLA series and HI CUPLA series. Please see page 19 for "HI CUPLA Series Interchangeability".

Minimum Cross-Sectional Area		(mm <sup>2</sup> )										
Socket	Plug	17PH	20PH	30PH	40PH	10PM	20PM	30PM	40PM	20PF	30PF	40PF
20SH-BL		16	20	20	20	13	20	20	20	20	20	20
20SM-BL		16	20	33	33	13	33	33	33	33	33	33
20SF-BL		16	20	33	33	13	33	33	33	33	33	33
30SH-BL		16	20	33	33	13	33	33	33	33	33	33
30SM-BL		16	20	33	33	13	33	33	33	33	33	33
30SF-BL		16	20	33	33	13	33	33	33	33	33	33
40SH-BL		16	20	33	33	13	33	33	33	33	33	33
40SM-BL		16	20	33	33	13	33	33	33	33	33	33
40SF-BL		16	20	33	33	13	33	33	33	33	33	33
65SN-BL		16	20	22	22	13	22	22	22	22	22	22
80SN-BL		16	20	33	33	13	33	33	33	33	33	33
85SN-BL		16	20	33	33	13	33	33	33	33	33	33

**Suitability for Vacuum**  
Not suitable for vacuum application in either connected or disconnected condition.

**Pressure - Flow Characteristics**

[Test conditions] • Fluid : Air • Temperature : Room temperature

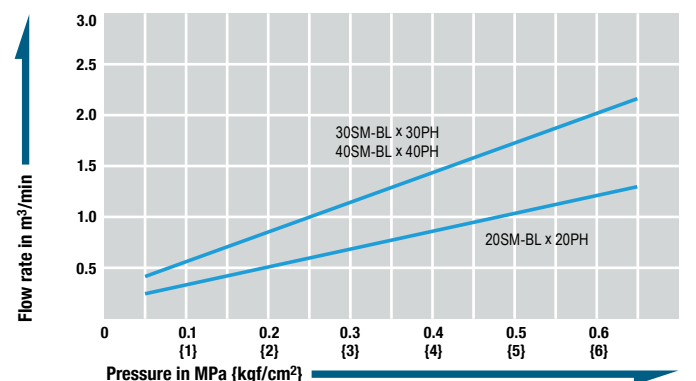

Models and Dimensions

Steel

Socket SH-BL type (Hose barb)

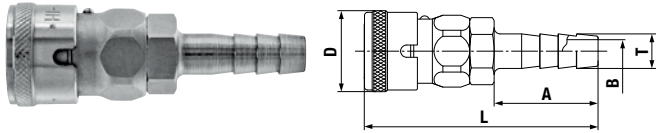

Model	Application (Hose)	Mass (g)	Dimensions (mm)				
			L	øD	A	øT	øB
20SH-BL	1/4"	103	(72.5)	(26.5)	30	9	5
30SH-BL	3/8"	106	(76.5)	(26.5)	34	11.3	7.5
40SH-BL	1/2"	118	(78.5)	(26.5)	36	15	9

Socket SM-BL type (Male thread)

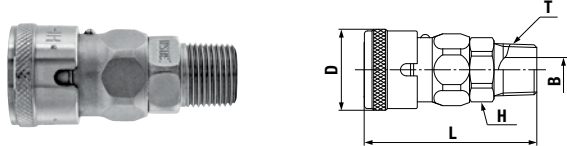

Model	Application (Thread)	Mass (g)	Dimensions (mm)				
			L	øD	H(WAF)	T	øB
20SM-BL	Rc 1/4	101	(55.5)	(26.5)	Hex.19	R 1/4	7
30SM-BL	Rc 3/8	108	(56.5)	(26.5)	Hex.19	R 3/8	8
40SM-BL	Rc 1/2	131	(59.5)	(26.5)	Hex.23	R 1/2	9

Socket SF-BL type (Female thread)

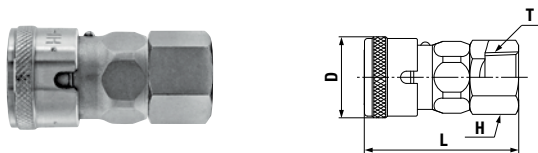

Model	Application (Thread)	Mass (g)	Dimensions (mm)			
			L	øD	H(WAF)	T
20SF-BL	R 1/4	95	(49.5)	(26.5)	Hex.19	Rc 1/4
30SF-BL	R 3/8	103	(50.5)	(26.5)	Hex.21	Rc 3/8
40SF-BL	R 1/2	139	(52.5)	(26.5)	Hex.29	Rc 1/2

Socket SN-BL type (For urethane hose connection)

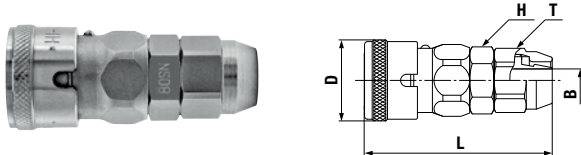

Model	Application (Hose)	Mass (g)	Dimensions (mm)				
			L	øD	øB	H(WAF)	T(WAF)
65SN-BL	ø6.5 x ø10	115	(59.5)	(26.5)	5.3	Hex.19	Hex.17
80SN-BL	ø8 x ø12	120	(61.5)	(26.5)	7.5	Hex.19	Hex.19
85SN-BL	ø8.5 x ø12.5	120	(61.5)	(26.5)	7.5	Hex.19	Hex.19

\* Above pictures are sockets of 30 and 80 models.



Stainless steel

Socket SH-BL type (Hose barb)

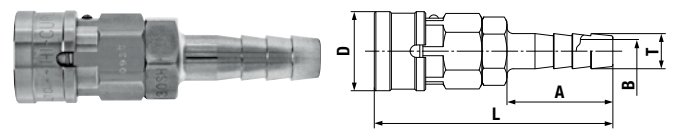

Model	Application (Hose)	Mass (g)	Dimensions (mm)				
			L	øD	A	øT	øB
20SH-BL	1/4"	100	(72.5)	25.4	30	9	5
30SH-BL	3/8"	101	(76.5)	25.4	34	11.3	7.5
40SH-BL	1/2"	118	(78.5)	25.4	36	15	9

Socket SM-BL type (Male thread)

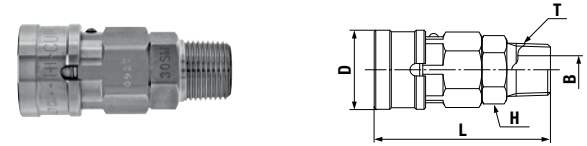

Model	Application (Thread)	Mass (g)	Dimensions (mm)				
			L	øD	H(WAF)	T	øB
20SM-BL	Rc 1/4	96	(55.5)	25.4	Hex.19	R 1/4	7
30SM-BL	Rc 3/8	105	(56.5)	25.4	Hex.19	R 3/8	9
40SM-BL	Rc 1/2	120	(59.5)	25.4	Hex.22	R 1/2	9

Socket SF-BL type (Female thread)



Model	Application (Thread)	Mass (g)	Dimensions (mm)			
			L	øD	H(WAF)	T
20SF-BL	R 1/4	98	(49.5)	25.4	Hex.19	Rc 1/4
30SF-BL	R 3/8	99	(50.5)	25.4	Hex.21	Rc 3/8
40SF-BL	R 1/2	138	(52.5)	25.4	Hex.29	Rc 1/2

**Unlocked**

Align the cutout in the sleeve with the ball stopper, and pull the sleeve to connect the plug.

Cutout in the sleeve

Ball stopper

The stopper is marked with blue for visual understanding.

**Locking the sleeve**

Without alignment of the cutout with the ball stopper disconnection cannot be made.

**Accidental disconnection is prevented.**

Locked



Align the cutout in the sleeve with the ball stopper, and pull the sleeve for disconnection.



For Low Pressure (Air)

# HI CUPLA 200

Push-to-connect type for air lines

<p>Working pressure</p>  <p>1.5 MPa (15 kgf/cm<sup>2</sup>)</p>	<p>Valve structure</p>  <p>One-way shut-off</p>	<p>Applicable fluid</p>  <p>Air</p>
---	--	--

Simple and secure push-to-connect type! Big flow rate! End-face seal design. Gives excellent handling touch.

- Just push the plug into the socket for simple and secure connection. This reduces connection time and improves efficiency.
- New valve design for low pressure loss to achieve flow rate increase (15% up over the conventional model).
- End-face seal is achieved when connected.
- Enhanced operability with low connection resistance.
- End-face seal design is superior to external seal with an O-ring due to no seal damage caused by exhausted lubrication.
- Available only with steel body. Not suitable for water or oil.
- Also available with quick connect/disconnect Tube Fitter type.



▼ With Tube Fitter



Specifications				
Body material	Steel (Chrome plated)			
Size	Thread and hose barb	1/4", 3/8", 1/2"		
	Tube barb (Tube fitter)	Polyurethane tube: Outer dia. $\phi 6 \pm 0.1$ , $\phi 8 \pm 0.15$ , $\phi 10 \pm 0.15$ Polyamide tube: Outer dia. $\phi 6^{+0.05}_{-0.08}$ , $\phi 8^{+0.05}_{-0.1}$ , $\phi 10^{+0.05}_{-0.1}$ Fluorine contained resin tube: Outer dia. $\phi 6 \pm 0.07$ , $\phi 8 \pm 0.07$ , $\phi 10 \pm 0.07$		
Pressure unit	MPa	kgf/cm <sup>2</sup>	bar	PSI
Working pressure	1.5	15	15	218
Seal material	Seal material	Mark	Working temperature range	Remarks
Working temperature range	Nitrile rubber	NBR (SG)	-20°C to +60°C	Standard material

\* Above specifications apply only to CUPLA. Maximum working pressure and working temperature range may vary depending on materials of the tube and the working temperature.

Maximum Tightening Torque		Nm {kgf·cm}		
Size (Thread)		1/4"	3/8"	1/2"
Torque		14 {143}	22 {224}	60 {612}

**Flow Direction**

Fluid must run from socket to plug.

**Interchangeability**

Interchangeable with plugs of HI CUPLA models 10, 17, 20, 30 and 40.  
Interchangeable with each models of NUT CUPLA series and HI CUPLA series (except models 400, 600, and 800).  
Please see page 19 for "HI CUPLA Series Interchangeability".

Minimum Cross-Sectional Area		(mm <sup>2</sup> )										
Socket	Plug	17PH	20PH	30PH	40PH	10PM	20PM	30PM	40PM	20PF	30PF	40PF
200-17SH		16	16	16	16	13	16	16	16	16	16	16
200-20SH		16	20	20	20	13	20	20	20	20	20	20
200-30SH		16	20	41	41	13	41	41	41	41	41	41
200-40SH		16	20	41	41	13	41	41	41	41	41	41
200-20SM		16	20	41	41	13	41	41	41	41	41	41
200-30SM		16	20	41	41	13	41	41	41	41	41	41
200-40SM		16	20	41	41	13	41	41	41	41	41	41
200-20SF		16	20	41	41	13	41	41	41	41	41	41
200-30SF		16	20	41	41	13	41	41	41	41	41	41
200-40SF		16	20	41	41	13	41	41	41	41	41	41

**Suitability for Vacuum**

Not suitable for vacuum application in either connected or disconnected condition.

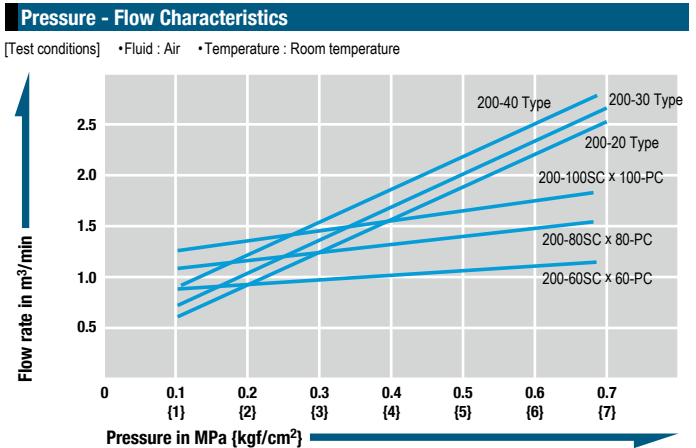

**Models and Dimensions** WAF : WAF stands for width across flats.

**Socket SH type (Hose barb)**

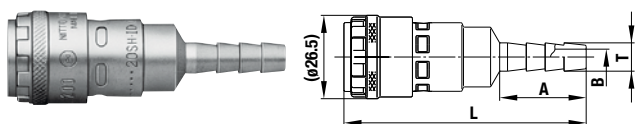

Model	Application (Hose)	Mass (g)	Dimensions (mm)			
			L	A	øT	øB
200-17SH	1/4"	86	(77)	27	7.2	4.5
200-20SH	1/4"	90	(77)	27.5	9	5
200-30SH	3/8"	92	(79)	32	11.3	7.5
200-40SH	1/2"	104	(79.5)	32	15	10

**Socket SM type (Male thread)**

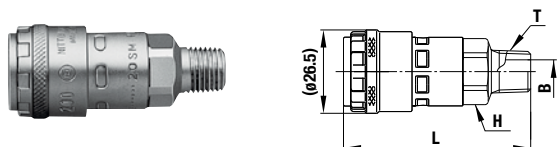

Model	Application (Thread)	Mass (g)	Dimensions (mm)			
			L	H(WAF)	T	øB
200-20SM	Rc 1/4	89	(60)	Hex.19	R 1/4	7.5
200-30SM	Rc 3/8	91	(60.5)	Hex.19	R 3/8	10
200-40SM	Rc 1/2	102	(56)	Hex.24	R 1/2	13

**Socket SF type (Female thread)**

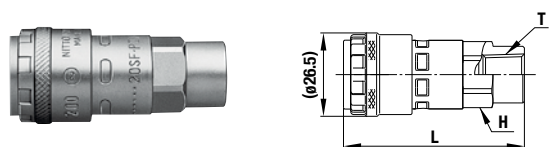

Models	Application (Thread)	Mass (g)	Dimensions (mm)		
			L	H(WAF)	T
200-20SF	R 1/4	94	(57.5)	Hex.19	Rc 1/4
200-30SF	R 3/8	103	(55.5)	Hex.22	Rc 3/8
200-40SF	R 1/2	138	(57.5)	Hex.29	Rc 1/2

**Models and Dimensions (With Tube Fitter)**

**Socket SC type (Tube Fitter)**

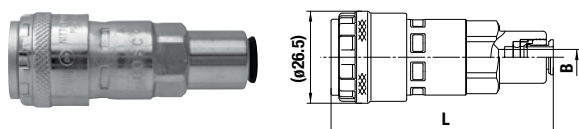

Model	Application (Tube)	Mass (g)	Dimensions (mm)	
			L	øB
200-60SC	For 6 mm OD tube	100	(64)	5
200-80SC	For 8 mm OD tube	105	(67.5)	6.5
200-100SC	For 10 mm OD tube	123	(70.5)	8.5

\* The outer dimensions of Model 200-100SC are a little bit different from those of other models.

**Application example**

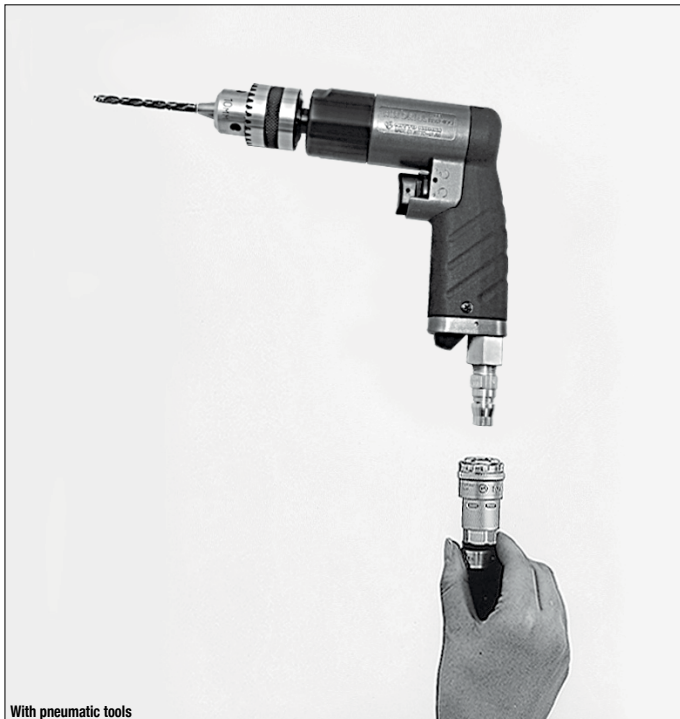
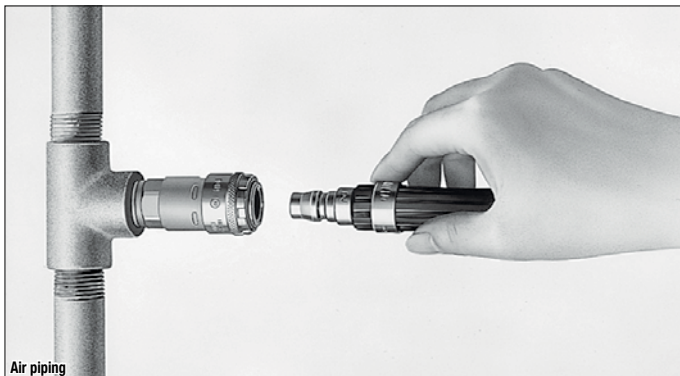

All of socket, plug and tube can be connected in one push-to-connect operation.

Just push the tube into CUPLA and then it is locked.  
Polyurethane, Nylon and Fluorine contained resin tubes.

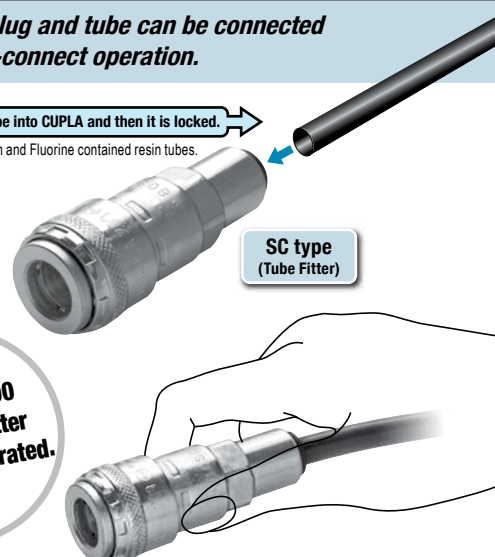

HI CUPLA 200 and Tube Fitter are now integrated.

Major applications: miniature pneumatic equipment, automatic control equipment, physicochemical equipment and medical devices.

Just push in for quick connection.

## For Low Pressure (Air)

# HI CUPLA for Connection to Braided Hoses

## NUT CUPLA

## NUT CUPLA 200

## ROTARY NUT CUPLA

For connection to urethane hose, braided hose

Working pressure

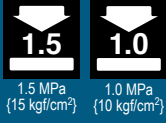

Valve structure



Applicable fluids (Steel applies to air only)



**No hose clamp required!**  
**Fitted with hose guard nut to prevent possible kinking.**  
**HI CUPLA for connection to braided hoses is now available.**

- Nut types are available in HI CUPLA Series and HI CUPLA 200 Series. Hose guard nut type available to prevent hose kinking.
- To mount on hose, simply slide it over the nipple and tighten the nut.
- The design to tighten outside of hose reduces hose slip away or fluid leaks.
- Also available are ROTARY NUT CUPLA equipped with ball bearing swivel mechanism to prevent and relieve tension on operator's hands.

NUT CUPLA

NUT CUPLA 200

NUT CUPLA 200 with hose guard nut

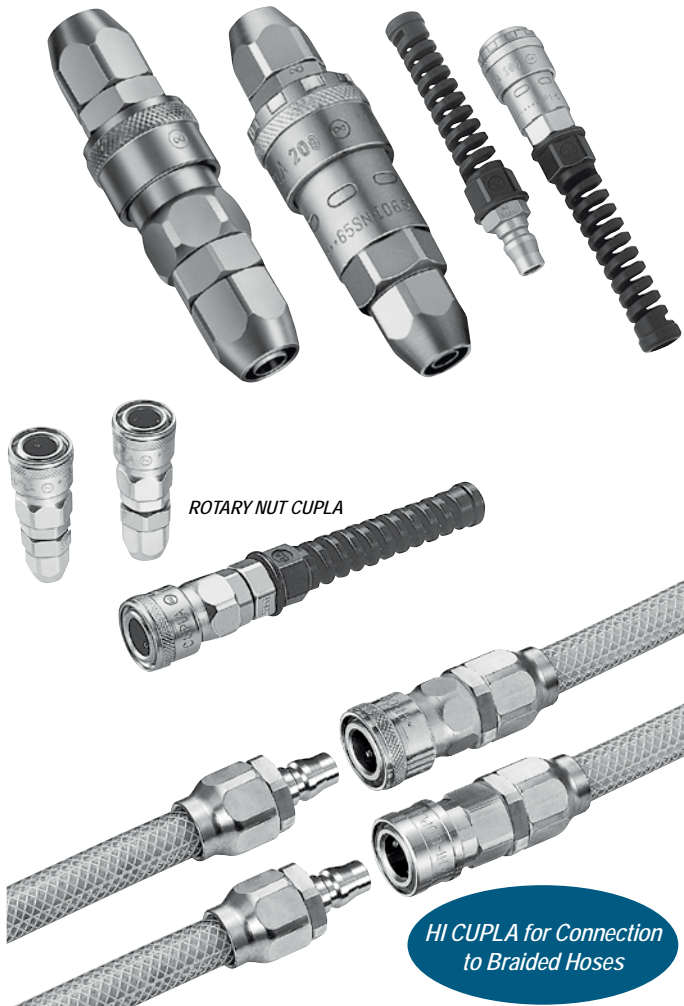

### Specifications (NUT CUPLA / NUT CUPLA 200 / ROTARY NUT CUPLA)

Body material	Steel (Chrome plated)			
Urethane hose size	For ø5 mm x ø8 mm, ø6 mm x ø9 mm hose For ø6.5 mm x ø10 mm, ø8 mm x ø12 mm hose For ø8.5 mm x ø12.5 mm, ø11 mm x ø16 mm hose			
Pressure unit	MPa	kgf/cm <sup>2</sup>	bar	PSI
Working pressure	1.5	15	15	218
Seal material	Seal material	Mark	Working temperature range	Remarks
Working temperature range	Nitrile rubber	NBR (SG)	-20°C to +60°C	Standard material

### Specifications (HI CUPLA for Connection to Braided Hoses)

Body material	Steel (Chrome plated)		Brass	
Braided hose size	For ø9 mm x ø15 mm hose			
Working pressure	MPa	1.5	1.0	
	kgf/cm <sup>2</sup>	15	10	
	bar	15	10	
	PSI	218	145	
Seal material	Seal material	Mark	Working temperature range	Remarks
Working temperature range	Nitrile rubber	NBR (SG)	-20°C to +80°C	Standard material

Maximum working pressure and temperature range of PN/SN type for braided hoses depends on the specification of the braided hose to be used.

### Tightening Torque Range

Nm {kgf·cm}

Model	SN, PN, SNR Type	65SNG, PNG, SNRG Type	85SNG, PNG, SNRG Type
Torque	9 to 11 {92 to 112}	5 to 6 {51 to 61}	7 to 8 {71 to 82}

To mount on braided hose or urethane hose, slide it over to the hose barb and tighten the nut until it is flush against the hose barb base. It is recommended that grease is applied to the inside of the nut (threaded part and hose contact part) for easy tightening.

### Flow Direction

Fluid must run from socket to plug.



### Interchangeability

Interchangeable with HI CUPLA models 10, 17, 20, 30 and 40. Interchangeable with each models of NUT CUPLA series and HI CUPLA series (except models 400, 600, and 800). Please see page 19 for "HI CUPLA Series Interchangeability".

### Minimum Cross-Sectional Area

(mm<sup>2</sup>)

Socket	Plug	17PH	20PH	30PH	40PH	10PM	20PM	30PM	40PM	20PF	30PF	40PF	90PN-BH
		200-50SN	16	16	16	16	13	16	16	16	16	16	16
200-60SN	16	20	22	22	13	22	22	22	22	22	22	22	22
200-65SN	16	20	22	22	13	22	22	22	22	22	22	22	22
200-80SN	16	20	41	41	13	41	41	41	41	41	41	41	41
200-85SN	16	20	41	41	13	41	41	41	41	41	41	41	41
200-110SN	16	20	41	41	13	41	41	41	41	41	41	41	41
200-50SNG	16	16	16	16	13	16	16	16	16	16	16	16	16
200-65SNG	16	20	22	22	13	22	22	22	22	22	22	22	22
200-85SNG	16	20	40	41	13	41	41	41	41	41	41	41	41
90SN-BH	16	20	33	33	13	33	33	33	33	33	33	33	33

### Suitability for Vacuum

Not suitable for vacuum application in either connected or disconnected condition.

### Pressure - Flow Characteristics

[Test conditions] • Fluid : Air • Temperature : Room temperature

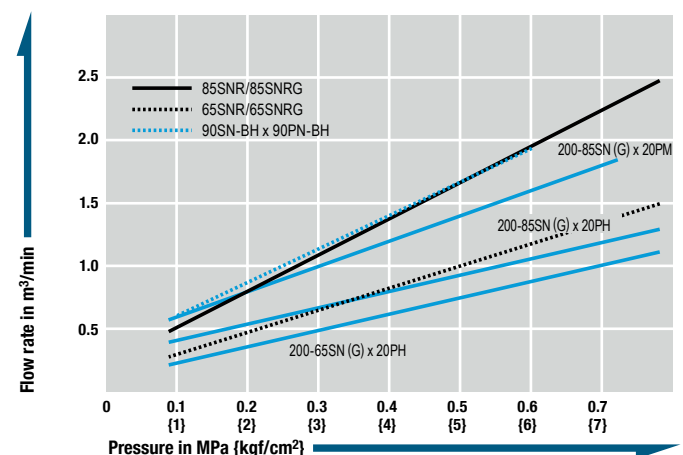



**Plug PN type (HI CUPLA for connection to braided hoses)**

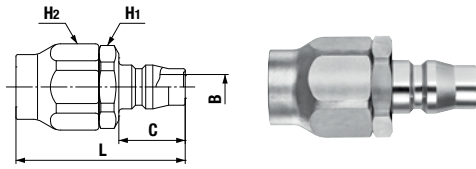

Grease is applied to the threaded part of steel nut to prevent galling.

Model	Application (Hose)	Wall Thickness (mm)	Body material·Mass (g)		Dimensions (mm)				
			Steel	Brass	L	H1(WAF)	H2(WAF)	C	øB
90PN-BH	ø9 x ø15	3±0.3	86	88	(51)	Hex.23	Hex.24	20	7.5

**Socket SN type (HI CUPLA for connection to braided hoses)**

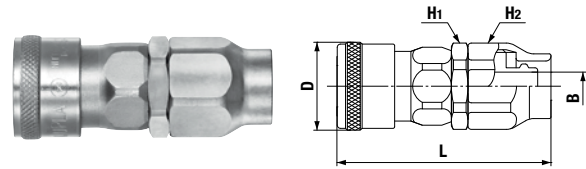

Grease is applied to the threaded part of steel nut to prevent galling.

Model	Application (Hose)	Wall Thickness (mm)	Body material·Mass (g)		Dimensions (mm)				
			Steel	Brass	L	øD	H1(WAF)	H2(WAF)	øB
90SN-BH	ø9 x ø15	3±0.3	147	154	(64.5)	(26.5) <sub>-1</sub>	Hex.24	Hex.24	8.5

**Plug PN type (NUT CUPLA for urethane hose connection)**

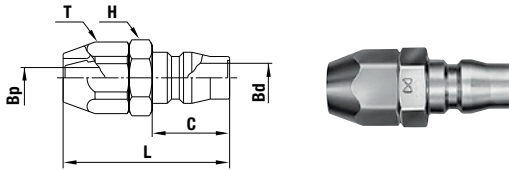

Grease is applied to the threaded part of stainless steel nut to prevent galling.

Model	Application (Hose)	Body material·Mass (g)		Dimensions (mm)					
		Steel	Stainless steel	L	C	øBp	øBd	H(WAF)	T(WAF)
50PN	ø5 x ø8	30	-	(43)	20	4.5	7.5	Hex.17	Hex.17
60PN	ø6 x ø9	40	-	(43)	20	5.3	7.5	Hex.17	Hex.17
65PN	ø6.5 x ø10	42	43	(43)	20	5.3	7.5	Hex.17	Hex.17
80PN	ø8 x ø12	50	52	(45)	20	7.5	7.5	Hex.19	Hex.19
85PN	ø8.5 x ø12.5	52	53	(45)	20	7.5	7.5	Hex.19	Hex.19
110PN	ø11 x ø16	75	-	(52)	20	7.5	7.5	Hex.23	Hex.24

**Socket SN type (NUT CUPLA for urethane hose connection)**

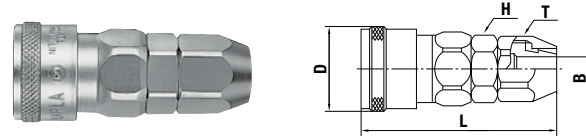

Grease is applied to the threaded part of stainless steel nut to prevent galling.

Model	Application (Hose)	Body material·Mass (g)		Dimensions (mm)				
		Steel	Stainless steel	L	øD	øB	H(WAF)	T(WAF)
50SN	ø5 x ø8	117	-	(60)	(26.5)	4.5	Hex.19	Hex.17
60SN	ø6 x ø9	115	-	(59.5)	(26.5)	5.3	Hex.19	Hex.17
65SN	ø6.5 x ø10	115	110	(59.5)	(26.5) <sub>-2</sub>	5.3	Hex.19	Hex.17
80SN	ø8 x ø12	120	114	(61.5)	(26.5) <sub>-2</sub>	7.5	Hex.19	Hex.19
85SN	ø8.5 x ø12.5	120	115	(61.5)	(26.5) <sub>-2</sub>	7.5	Hex.19	Hex.19
110SN	ø11 x ø16	153	-	(64.5)	(26.5)	10	Hex.23	Hex.24

**Socket SN type (NUT CUPLA 200 for urethane hose connection)**

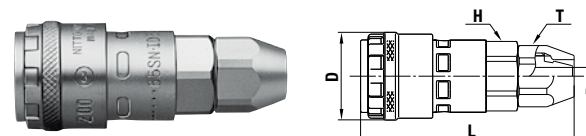

Model	Application (Hose)	Mass (g)	Dimensions (mm)				
			L	øD	øB	H(WAF)	T(WAF)
200-50SN	ø5 x ø8	105	(64.5)	(26.5)	4.5	Hex.19	Hex.17
200-60SN	ø6 x ø9	105	(64.5)	(26.5)	5.3	Hex.19	Hex.17
200-65SN	ø6.5 x ø10	106	(64.5)	(26.5)	5.3	Hex.19	Hex.17
200-80SN	ø8 x ø12	112	(66.5)	(26.5)	7.5	Hex.19	Hex.19
200-85SN	ø8.5 x ø12.5	113	(66.5)	(26.5)	7.5	Hex.19	Hex.19
200-110SN	ø11 x ø16	127	(62)	(26.5)	10	Hex.23	Hex.24

**Plug PNG type (For urethane hose with hose guard nut connection)**

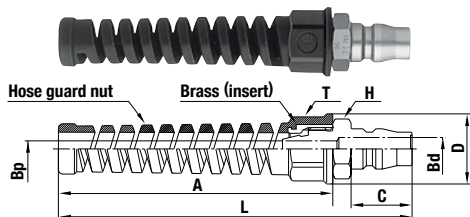

Model	Application (Hose)	Mass (g)	Dimensions (mm)						H(WAF)	T(WAF)
			L	C	A	øD	øBp	øBd		
50PNG *3	ø5 x ø8	41	(116)	20	90	23	4.5	7.5	Hex.17	Hex.19
65PNG	ø6.5 x ø10	43	(116)	20	90	23	5.3	7.5	Hex.17	Hex.19
85PNG	ø8.5 x ø12.5	55	(116)	20	90	26	7.5	7.5	Hex.19	Hex.22

**Socket SNG type (For urethane hose with hose guard nut connection)**

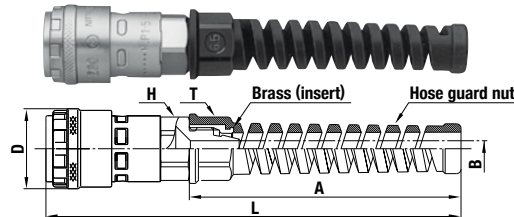

Model	Application (Hose)	Mass (g)	Dimensions (mm)					H(WAF)	T(WAF)
			L	A	øD	øB			
200-50SNG *3	ø5 x ø8	105	(137.5)	90	(26.5)	4.5	Hex.19	Hex.19	
200-65SNG	ø6.5 x ø10	107	(137.5)	90	(26.5)	5.3	Hex.19	Hex.19	
200-85SNG	ø8.5 x ø12.5	116	(137.5)	90	(26.5)	7.5	Hex.19	Hex.22	

**Socket SNR type (ROTARY NUT CUPLA with swivel mechanism)**

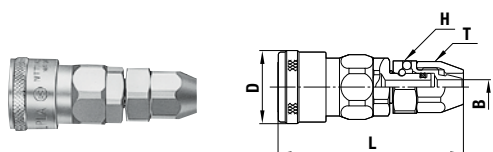

Model	Application (Hose)	Mass (g)	Dimensions (mm)				
			L	øD	øB	H(WAF)	T(WAF)
65SNR	ø6.5 x ø10	120	(67.3)	(26.5)	5.3	Hex.19	Hex.17
85SNR	ø8.5 x ø12.5	136	(69.3)	(26.5)	7.5	Hex.21	Hex.19

**Socket SNRG type (ROTARY NUT CUPLA with swivel mechanism)**

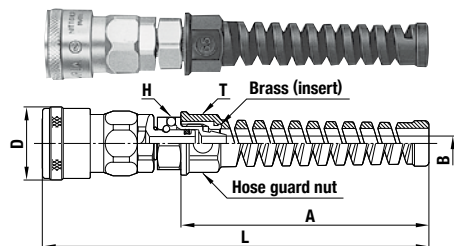

Model	Application (Hose)	Mass (g)	Dimensions (mm)					
			L	A	øD	øB	H(WAF)	T(WAF)
65SNRG	ø6.5 x ø10	121	(140.3)	90	(26.5)	5.3	Hex.19	Hex.19
85SNRG	ø8.5 x ø12.5	139	(140.3)	90	(26.5)	7.5	Hex.21	Hex.22

The pictures of HI CUPLA for connection to braided hoses and PN type and SN type of NUT CUPLA show steel bodies.

\*1: Brass: øD=25.4 \*2: Stainless steel: øD=25.4 \*3: Made-to-order item

Before use, please be sure to read "Safety Guide" described at the end of this book and "Instruction Sheet" that comes with the products.



For Low Pressure (Air)

# LOCK CUPLA 200

Air line coupling with sleeve safety lock feature

Working pressure: **1.5** MPa (15 kgf/cm<sup>2</sup>)

Valve structure: One-way shut-off

Applicable fluid: Air

Push-to-connect operation. Added easy lock design for safety!



- Locking mechanism prevents accidental disconnection after connection. Good for connections between hoses.
- Simple one push of plug and socket to each other for connection. Easy handling improves job efficiency.
- Ball bearing swivel mechanism prevents hose twists and relieves load on holding hands (SNRG type).
- To mount on hose, simply slide it over the nipple and tighten the nut (SNRG type).
- Hose guard nut to prevent hose from kinking as a standard feature (SNRG type).
- Low pressure loss valve design gives improved flow rate.

### Application Example

Applicable fluid	Application
Air	Pneumatic tools, Pneumatic devices, Various air piping

### Suitability for Vacuum

Not suitable for vacuum application in either connected or disconnected condition.

### Minimum Cross-sectional Area (mm<sup>2</sup>)

Plug LOCK CUPLA 200	Application (Hose)										
	17PH	20PH	30PH	40PH	10PM	20PM	30PM	40PM	20PF	30PF	40PF
L200-20SH	16	20	20	20	13	20	20	20	20	20	20
L200-30SH	16	20	41	41	13	41	41	41	41	41	41
L200-40SH	16	20	41	41	13	41	41	41	41	41	41
L200-20SM	16	20	41	41	13	41	41	41	41	41	41
L200-30SM	16	20	41	41	13	41	41	41	41	41	41
L200-40SM	16	20	41	41	13	41	41	41	41	41	41
L200-20SF	16	20	41	41	13	41	41	41	41	41	41
L200-30SF	16	20	41	41	13	41	41	41	41	41	41
L200-40SF	16	20	41	41	13	41	41	41	41	41	41
L200-65SNRG	16	20	20	20	13	20	20	20	20	20	20
L200-85SNRG	16	38	38	38	13	38	38	38	38	38	38

### Pressure - Flow Characteristics

[Test conditions] • Fluid : Air • Temperature : Room temperature

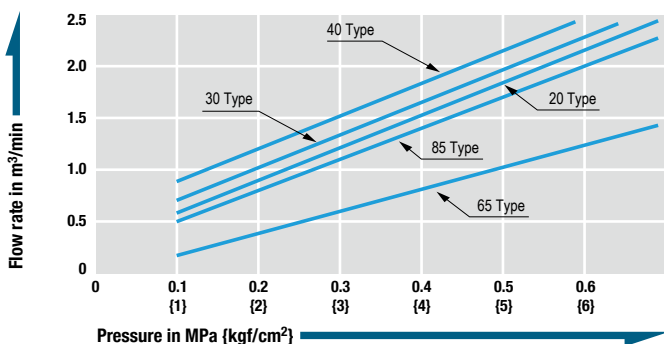

### Specifications

Body material		Steel (Chrome plated)			
Size	Thread and hose barb	1/4", 3/8", 1/2"			
	SNRG type	For ø6.5 mm x ø10mm, ø8.5 mm x ø12.5 mm hose			
Pressure unit	MPa	kgf/cm <sup>2</sup>	bar	PSI	
Working pressure	1.5	15	15	218	
Seal material	Nitrile rubber	NBR (SG)	-20°C to +60°C	Standard material	

### Maximum Tightening Torque, Tightening Torque Range Nm {kgf·cm}

Type of connection	Thread			Hose guard nut	
Applicable size	1/4"	3/8"	1/2"	ø6.5 mm x ø10mm	ø8.5 mm x ø12.5mm
Torque	14 {143}	22 {224}	60 {612}	5 to 6 {51 to 61}	7 to 8 {71 to 82}

To mount on urethane hose, slide it over to the hose barb and tighten the nut until it is flush against the hose barb base. It is recommended that grease is applied to the inside of the nut (threaded part and hose contact part) for easy tightening.

### Flow Direction

Fluid must run from socket to plug.

### Interchangeability

Interchangeable with plugs of HI CUPLA models 10, 17, 20, 30 and 40. Interchangeable with each models of NUT CUPLA series and HI CUPLA series. Please see page 19 for "HI CUPLA Series Interchangeability".

### Models and Dimensions

WAF : WAF stands for width across flats.

#### Socket SH type (Hose barb)

Model	Application (Hose)	Mass (g)	Dimensions (mm)			
			L	A	øT	øB
L200-20SH	1/4"	90	(77)	27.5	9	5
L200-30SH	3/8"	92	(79)	32	11.3	7.5
L200-40SH	1/2"	104	(79.5)	32	15	10

#### Socket SM type (Male thread)

Model	Application (Thread)	Mass (g)	Dimensions (mm)			
			L	H(WAF)	T	øB
L200-20SM	Rc 1/4	89	(60)	Hex.19	R 1/4	7.5
L200-30SM	Rc 3/8	91	(60.5)	Hex.19	R 3/8	10
L200-40SM	Rc 1/2	102	(56)	Hex.24	R 1/2	13

#### Socket SF type (Female thread)

Model	Application (Thread)	Mass (g)	Dimensions (mm)		
			L	H(WAF)	T
L200-20SF	R 1/4	94	(57.5)	Hex.19	Rc 1/4
L200-30SF	R 3/8	103	(55.5)	Hex.22	Rc 3/8
L200-40SF	R 1/2	138	(57.5)	Hex.29	Rc 1/2

#### Socket SNRG type (For hose with hose guard nut connection)

Model	Application (Hose)	Mass (g)	Dimensions (mm)				
			L	A	H(WAF)	T(WAF)	øB
L200-65SNRG	ø6.5 mm x ø10 mm	125	(147.8)	(90)	Hex.19	Hex.19	5.3
L200-85SNRG	ø8.5 mm x ø12.5 mm	132	(146.8)	(90)	Hex.21	Hex.22	7.5

Before use, please be sure to read "Safety Guide" described at the end of this book and "Instruction Sheet" that comes with the products.

For Low Pressure (Air)

# HI CUPLA

## Two Way Type

For bi-directional compressed air flow

Working pressure



Valve structure



Applicable fluid



Air flows in either direction from plug or from socket side when coupled. Ideal for connection of factory air supply lines to pneumatic devices.

- Can be connected with plugs for HI CUPLA Models 10, 17, 20, 30 and 40 and allows fluid to flow from either plug or socket side when coupled.
- Wide range of connections such as from ports on air pipes in factory to individual pneumatic devices.
- Critical structural parts are heat-treated for increased strength giving greater durability and resistance to wear.
- Available in various sizes and end configurations to suit a wide range of applications.



### Pressure - Flow Characteristics

[Test conditions] • Fluid : Air • Temperature : Room temperature

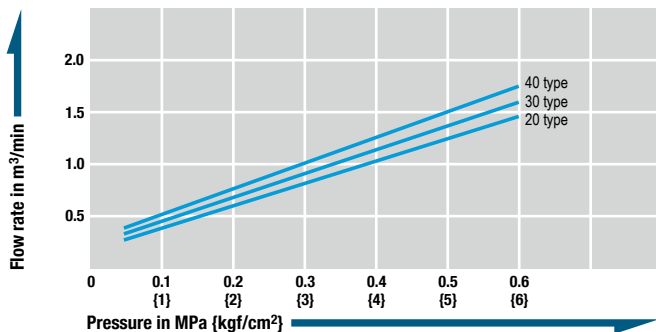

Specifications		Body material of brass or stainless steel is available as made-to-order item.			
Body material		Steel (Chrome plated)			
Size	Thread	1/4", 3/8", 1/2"			
	Hose barb	For $\phi 6.5$ mm x $\phi 10$ mm, $\phi 8.5$ mm x $\phi 12.5$ mm hose			
Pressure unit	MPa	kgf/cm <sup>2</sup>	bar	PSI	
Working pressure	1.5	15	15	218	
Seal material	Seal material	Mark	Working temperature range	Remarks	
Working temperature range	Nitrile rubber	NBR (SG)	-20°C to +80°C	Standard material	
	Fluoro rubber	FKM (X-100)	-20°C to +180°C	Made-to-order item	

Maximum Tightening Torque		Nm {kgf·cm}		
Size (Thread)	1/4"	3/8"	1/2"	
Torque	14 {143}	22 {224}	60 {612}	

### Flow Direction

Fluid flow can be bi-directional when socket and plug are connected.

### Interchangeability

Interchangeable with plugs of HI CUPLA models 10, 17, 20, 30 and 40. Interchangeable with each models of NUT CUPLA series and HI CUPLA series. Please see page 19 for "HI CUPLA Series Interchangeability".

### Suitability for Vacuum

Not suitable for vacuum application in either connected or disconnected condition.

### Models and Dimensions

WAF - WAF stands for width across flats.

#### Socket SH type (Hose barb)

Model	Application (Hose)	Mass (g)	Dimensions (mm)				
			L	$\phi D$	A	$\phi T$	$\phi B$
TW20SH	1/4"	98	(72.5)	(26.5)	30	9	5
TW30SH	3/8"	102	(76.5)	(26.5)	34	11.3	7.5
TW40SH	1/2"	117	(78.5)	(26.5)	36	15	9

#### Socket SM type (Male thread)

Model	Application (Thread)	Mass (g)	Dimensions (mm)				
			L	$\phi D$	H(WAF)	T	$\phi B$
TW20SM	Rc 1/4	95	(55.5)	(26.5)	Hex.19	R 1/4	7
TW30SM	Rc 3/8	109	(56.5)	(26.5)	Hex.19	R 3/8	8
TW40SM	Rc 1/2	116	(59.5)	(26.5)	Hex.23	R 1/2	9

#### Socket SF type (Female thread)



Model	Application (Thread)	Mass (g)	Dimensions (mm)			
			L	$\phi D$	H(WAF)	T
TW20SF	R 1/4	95	(49.5)	(26.5)	Hex.19	Rc 1/4
TW30SF	R 3/8	96	(50.5)	(26.5)	Hex.21	Rc 3/8
TW40SF	R 1/2	137	(52.5)	(26.5)	Hex.29	Rc 1/2

Before use, please be sure to read "Safety Guide" described at the end of this book and "Instruction Sheet" that comes with the products.

For Low Pressure (Air)

# FULL-BLOW CUPLA

Air line coupling with low pressure loss and high flow rate

<p>Working pressure</p>  <p>1.5 MPa (15 kgf/cm<sup>2</sup>)</p>	<p>Valve structure</p>  <p>One-way shut-off</p>	<p>Applicable fluid</p>  <p>Air</p>
---	--	--

Unique full-open gate type valve mechanism realizes low pressure loss and high flow rate, which reduces required source air volume.

- The flow rate is increased by up to 40% more than that of conventional CUPLA.
  - During connection and disconnection, the valve is closed, enabling connection/disconnection under zero line pressure.
  - When the sleeve of socket is returned to its original position, the purge mechanism releases the residual air pressure in the plug, eliminating unpleasant popping noise and hose whip motion on disconnection.
  - Built-in sleeve lock mechanism prevents accidental disconnection of CUPLA, ensuring safe operation.
  - The valve can be opened and closed while the socket and plug are connected.
  - The weight is reduced by 30 to 45% compared with that of conventional CUPLA.
- Note: Direct mounting of FULL-BLOW CUPLA to percussive and vibrating tools should be avoided.

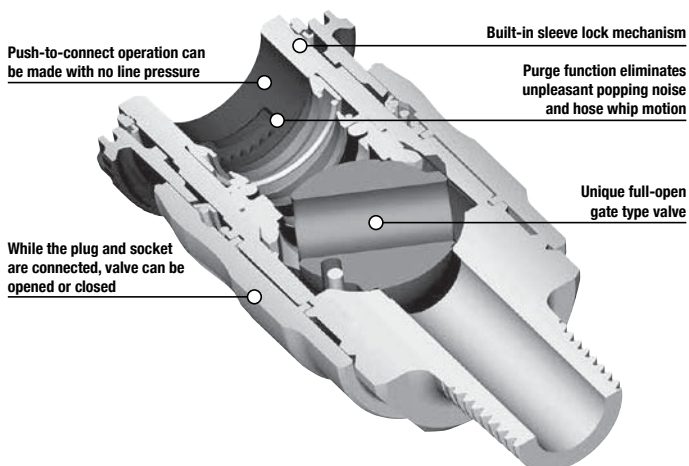

Specifications				
Body material	Aluminum alloy			
Size	Thread and hose barb	1/4", 3/8", 1/2"		
	SN type for urethane hose	For ø6.5 mm x ø10 mm, ø8 mm x ø12 mm polyurethane hose For ø8.5 mm x ø12.5 mm, ø11 mm x ø16 mm polyurethane hose		
Pressure unit	MPa	kgf/cm <sup>2</sup>	bar	PSI
Working pressure	1.5	15	15	218
Seal material	Seal material	Mark	Working temperature range	Remarks
Working temperature range	Nitrile rubber	NBR (SG)	-20 °C to +60 °C	Standard material

Maximum Tightening Torque				Nm {kgf·cm}
Size (Thread)	1/4"	3/8"	1/2"	
Torque	14 {143}	22 {224}	60 {612}	

Tightening Torque Range		Nm {kgf·cm}
SN Type for urethane hose		
9 to 11 {92 to 112}		

To mount on urethane hose, slide it over to the hose barb and tighten the nut until it is flush against the hose barb base. It is recommended that grease is applied to the inside of the nut (threaded part and hose contact part) for easy tightening.

**Flow Direction**

Fluid must run from socket to plug.

**Interchangeability**

Interchangeable with plugs of HI CUPLA models 10, 17, 20, 30 and 40.  
Interchangeable with each models of NUT CUPLA series and HI CUPLA series.  
Not interchangeable with some plugs of plastic HI CUPLA 250 (discontinued product).  
Please see page 19 for "HI CUPLA Series Interchangeability".

Minimum Cross-Sectional Area											(mm <sup>2</sup> )	
Socket	Plug	17PH	20PH	30PH	40PH	10PM	20PM	30PM	40PM	20PF	30PF	40PF
		FBH-20SH	16	20	24	24	13	24	24	24	24	24
FBH-30SH	16	20	44	44	13	44	44	44	44	44	44	44
FBH-40SH	16	20	44	44	13	44	44	44	44	44	44	44
FBH-20SM	16	20	44	44	13	44	44	44	44	44	44	44
FBH-30SM	16	20	44	44	13	44	44	44	44	44	44	44
FBH-40SM	16	20	44	44	13	44	44	44	44	44	44	44
FBH-20SF	16	20	44	44	13	44	44	44	44	44	44	44
FBH-30SF	16	20	44	44	13	44	44	44	44	44	44	44
FBH-40SF	16	20	44	44	13	44	44	44	44	44	44	44
FBH-65SN	16	20	24	24	13	24	24	24	24	24	24	24
FBH-80SN	16	20	44	44	13	44	44	44	44	44	44	44
FBH-85SN	16	20	44	44	13	44	44	44	44	44	44	44
FBH-110SN	16	20	44	44	13	44	44	44	44	44	44	44

**Suitability for Vacuum**

Not suitable for vacuum application in either connected or disconnected condition.

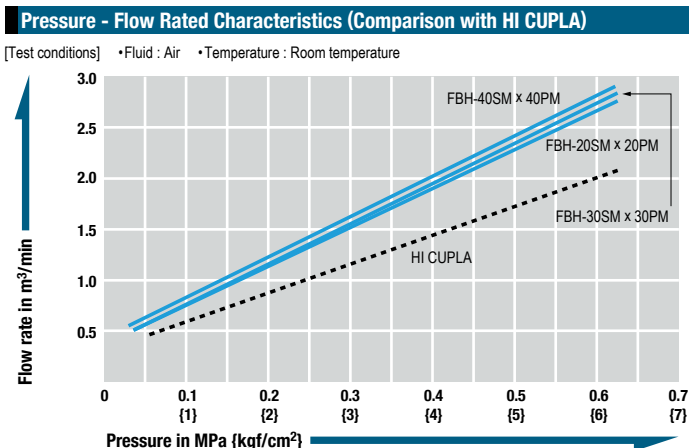

Models and Dimensions

WAF : WAF stands for width across flats.

Socket SH type (Hose barb)

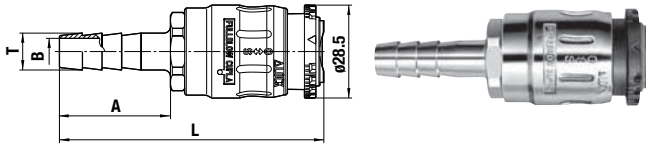

Model	Application (Hose)	Mass (g)	Dimensions (mm)			
			L	A	øT	øB
FBH-20SH	1/4"	70	(77)	30	9	5.5
FBH-30SH	3/8"	74	(81)	34	11.3	8
FBH-40SH	1/2"	85	(83)	36	15	10

Socket SM type (Male thread)

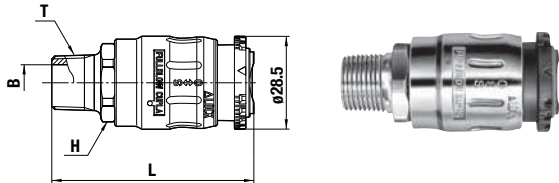

Model	Application (Thread)	Mass (g)	Dimensions (mm)			
			L	H(WAF)	T	øB
FBH-20SM	Rc 1/4	71	(62)	Hex.22	R 1/4	8
FBH-30SM	Rc 3/8	75	(62)	Hex.22	R 3/8	11
FBH-40SM	Rc 1/2	86	(66)	Hex.22	R 1/2	15

Socket SF type (Female thread)

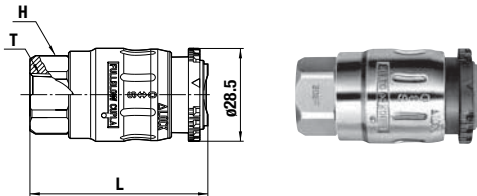

Model	Application (Thread)	Mass (g)	Dimensions (mm)		
			L	H(WAF)	T
FBH-20SF	R 1/4	77	(54.5)	Hex.22	Rc 1/4
FBH-30SF	R 3/8	69	(54.5)	Hex.22	Rc 3/8
FBH-40SF	R 1/2	90	(61)	Hex.26	Rc 1/2

Socket SN type (For urethane hose connection)

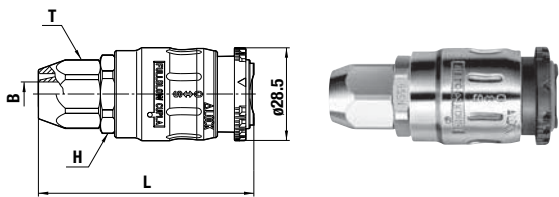

Model	Application (Hose)	Mass (g)	Dimensions (mm)			
			L	H(WAF)	T(WAF)	øB
FBH-65SN	ø6.5 mm x ø10 mm	64	(64)	Hex.22	Hex.17	5.5
FBH-80SN	ø8 mm x ø12 mm	67	(66)	Hex.22	Hex.19	7.5
FBH-85SN	ø8.5 mm x ø12.5 mm	68	(66)	Hex.22	Hex.19	7.5
FBH-110SN	ø11 mm x ø16 mm	86	(71)	Hex.26	Hex.24	10

Features of FULL-BLOW CUPLA

Up to about 40% increase in flow rate.

Pressure loss is reduced to the ultimate level. Up to about 40% increase in flow rate compared with conventional CUPLA.

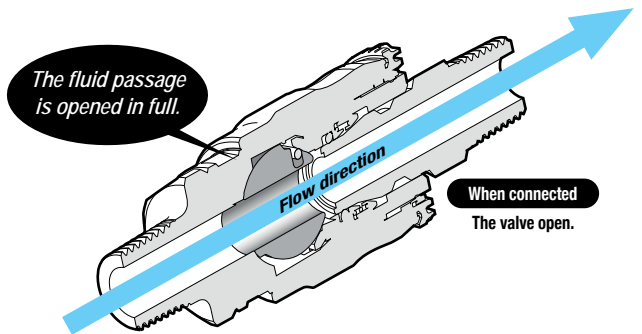
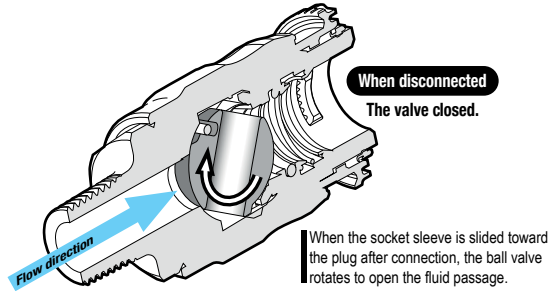

How It Works

1. Open the valve

Only after connection with the plug, you can slide the socket sleeve B toward the plug in order to open the built-in valve. Full flow path is then obtained.

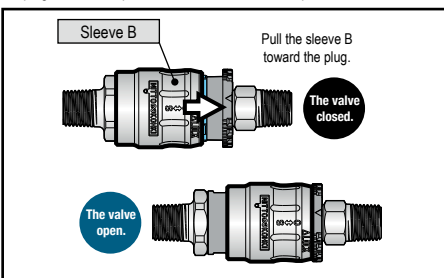

2. Lock the sleeve

Rotate the flange counterclockwise to lock the sleeve B. Without unlocking the plug you cannot disconnect.

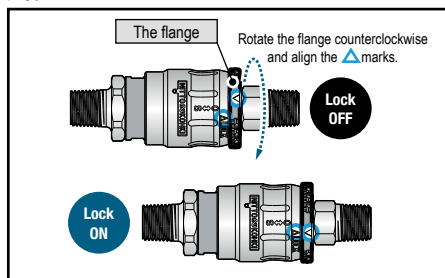

3. Purge the residual air

To disconnect the plug, first turn the flange back to its original position for unlocking and then pull the sleeve B back to the original position. The built-in valve will be closed to purge the residual air pressure.

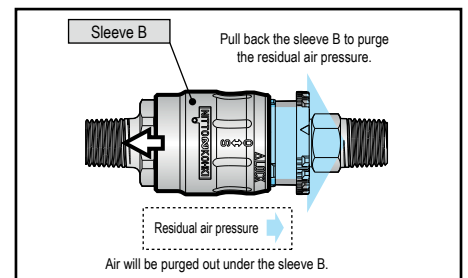

Before use, please be sure to read "Safety Guide" described at the end of this book and "Instruction Sheet" that comes with the products.





For Low Pressure (Air)

# PURGE HI CUPLA

## PVR Type

Air line coupling with built-in residual air pressure release function

<p>Working pressure</p>  <p>1.5 MPa (15 kgf/cm<sup>2</sup>)</p>	<p>Valve structure</p>  <p>One-way shut-off</p>	<p>Applicable fluid</p>  <p>Air</p>
---	--	--

Connection can be made smoothly regardless of the existing pressure inside the socket.

- Push-to-connect operation. Easy one-hand operation.
- Built-in sleeve lock mechanism prevents accidental disconnection of CUPLA, ensuring safe operation.
- Upon completion of sleeve locking the valve will open to supply air.
- When the sleeve is turned back to its original position, the valve is closed and purges residual air pressure in the plug without unpleasant popping noise and hose whip motion on disconnection.
- Even after connection, valve opening/closing control is possible.
- Flow rate increases by approximately 20% over that of HI CUPLA Model 400SM.
- Can be connected with plugs for HI CUPLA Models 400, 600 and 800.

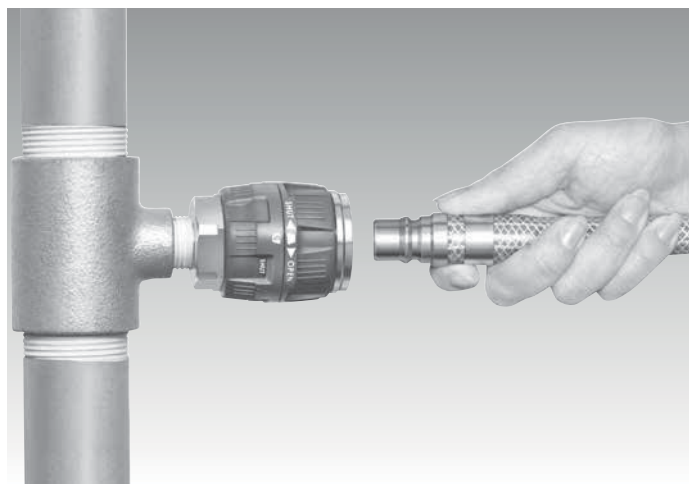

Specifications				
Body material	Zinc alloy (part Brass and others)			
Size	Thread	1/2", 3/4", 1"		
	Hose barb	1/2", 3/4", 1" hose		
Pressure unit	MPa	kgf/cm <sup>2</sup>	bar	PSI
Working pressure	1.5	15	15	218
Seal material	Seal material	Mark	Working temperature range	Remarks
	Nitrile rubber Hydrogenated nitrile rubber	NBR (SG)	-20°C to +60°C	Standard material

Maximum Tightening Torque		Nm {kgf·cm}		
Size (Thread)		1/2"	3/4"	1"
Torque		30 {306}	50 {510}	65 {663}

**Flow Direction**

Fluid must run from socket to plug.

**Interchangeability**

Can be connected with plugs of HI CUPLA models 400, 600 and 800. Please see page 19 for "HI CUPLA Series Interchangeability".

Minimum Cross-Sectional Area		(mm <sup>2</sup> )								
Model		400PH	600PH	800PH	400PM	600PM	800PM	400PF	600PF	800PF
PVR-400SH		64	71	71	71	71	71	71	71	71
PVR-600SH		64	116	116	116	116	116	116	116	116
PVR-800SH		64	116	116	116	116	116	116	116	116
PVR-400SM		64	116	116	116	116	116	116	116	116
PVR-600SM		64	116	116	116	116	116	116	116	116
PVR-800SM		64	116	116	116	116	116	116	116	116
PVR-400SF		64	116	116	116	116	116	116	116	116
PVR-600SF		64	116	116	116	116	116	116	116	116
PVR-800SF		64	116	116	116	116	116	116	116	116

**Suitability for Vacuum**

Not suitable for vacuum application in either connected or disconnected condition.

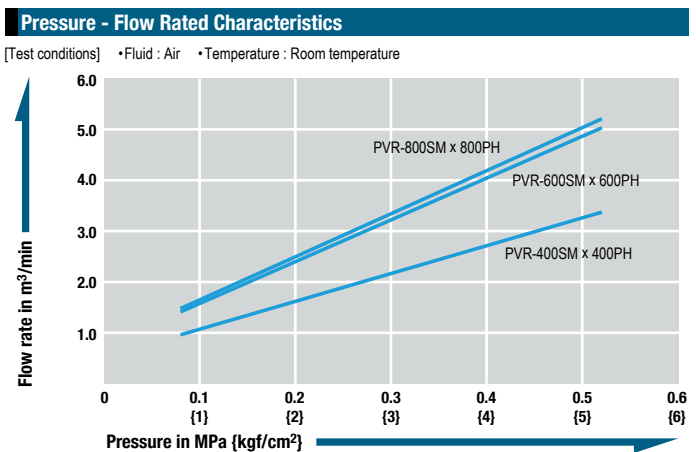

## Models and Dimensions

WAF : WAF stands for width across flats.

## Socket SH type (Hose barb)

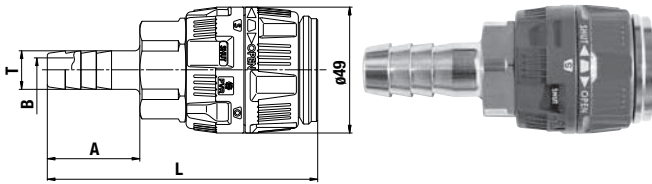

Model	Application (Hose)	Mass (g)	Dimensions (mm)			
			L	A	øT	øB
PVR-400SH	1/2"	380	(105)	36	15	9.5
PVR-600SH	3/4"	361	(109)	45	21	14
PVR-800SH	1"	440	(118)	55	27	16

## Socket SM type (Male thread)

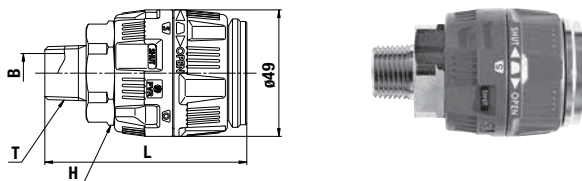

Model	Application (Thread)	Mass (g)	Dimensions (mm)			
			L	H(WAF)	T	øB
PVR-400SM	Rc 1/2	327	(78)	Hex.35	R 1/2	14
PVR-600SM	Rc 3/4	345	(82)	Hex.35	R 3/4	18
PVR-800SM	Rc 1	374	(84)	Hex.35	R 1	24

## Socket SF type (Female thread)

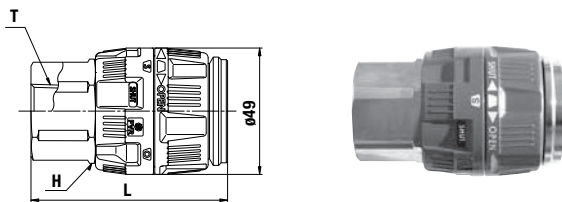

Model	Application (Thread)	Mass (g)	Dimensions (mm)		
			L	H(WAF)	T
PVR-400SF	R 1/2	394	(76)	Hex.35	Rc 1/2
PVR-600SF	R 3/4	370	(77)	Hex.35	Rc 3/4
PVR-800SF	R 1	440	(82)	Hex.41	Rc 1

## Function of PURGE HI CUPLA PVR Type

## 1. Connection

Valve opening/closing operation and plug connection to socket can be made independently. Push-to-connect operation is achieved regardless of existing pressure inside the pipe.

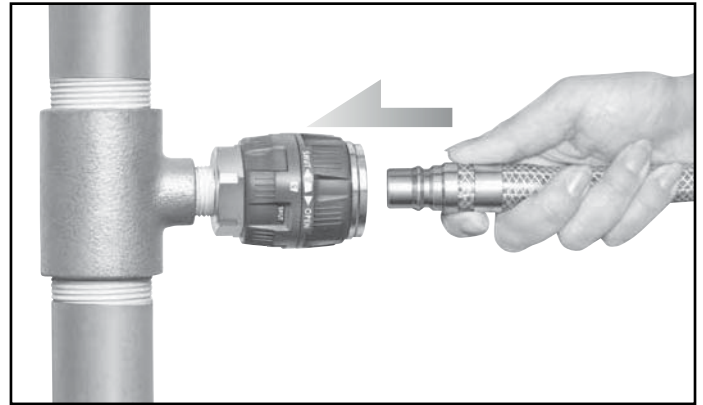

## 2. Open the valve and lock the sleeve.

Turning the operation ring will open the valve in the socket to supply air and lock the sleeve to prevent accidental disconnection.

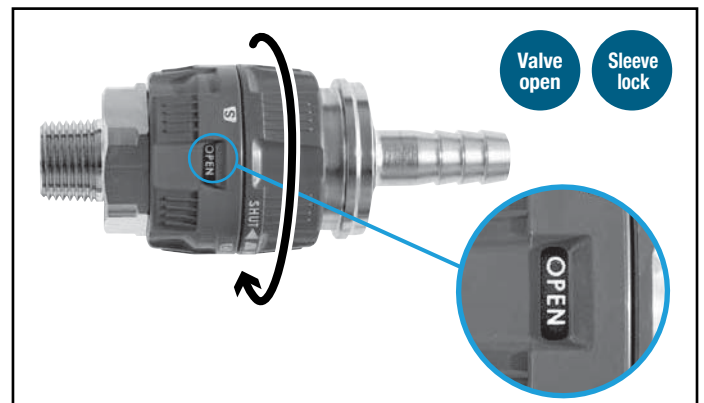

## 3. Close the valve and unlock the sleeve

Turning the operation ring back to its original position will close the valve and stop air flow, release the residual air pressure in the plug, and unlock the sleeve.

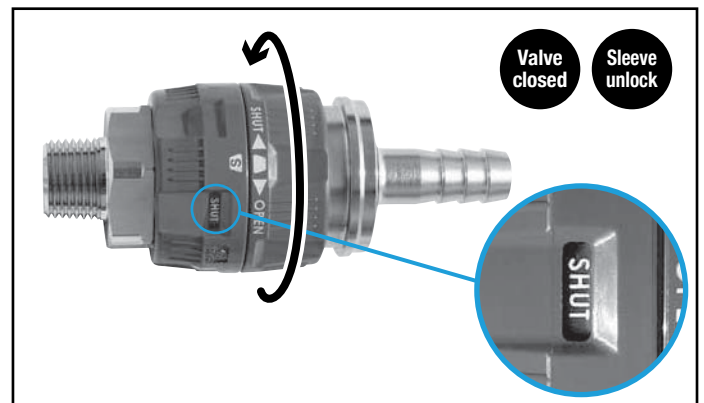

## 4. Disconnection

Disconnection can be made without unpleasant popping noise and hose whip motion due to no residual air pressure inside the plug.

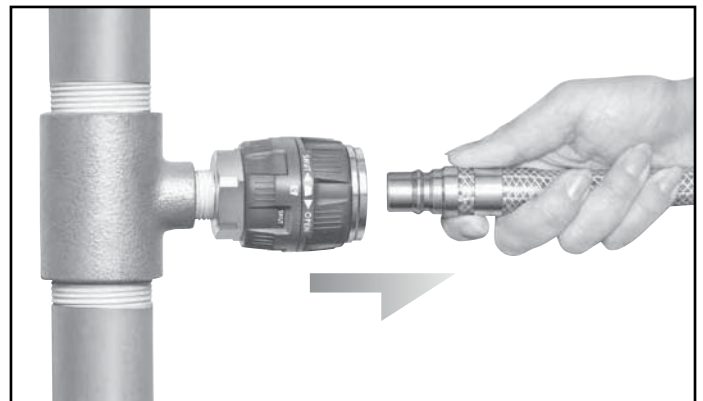

For Low Pressure (Air)

# PURGE HI CUPLA

Air line coupling with residual pressure release function

<p>Working pressure</p> <p>1.0 MPa (10 kgf/cm<sup>2</sup>)</p>	<p>Valve structure</p> <p>One-way shut-off</p>	<p>Applicable fluid</p> <p>Air</p>
--	--	------------------------------------

**Push-to-connect operation even with existing internal pressure! Eliminates unpleasant popping noise and hose whip motion on disconnection.**

- Just push in the plug for connection regardless of internal pressure in socket.
- Even after connection, lever operation gives perfect control over valve opening/closing.
- In disconnection, lever action releases residual air pressure in the plug without unpleasant popping noise and hose whip motion.
- Safe design prevents lever-operated valve from opening when plug is not connected.

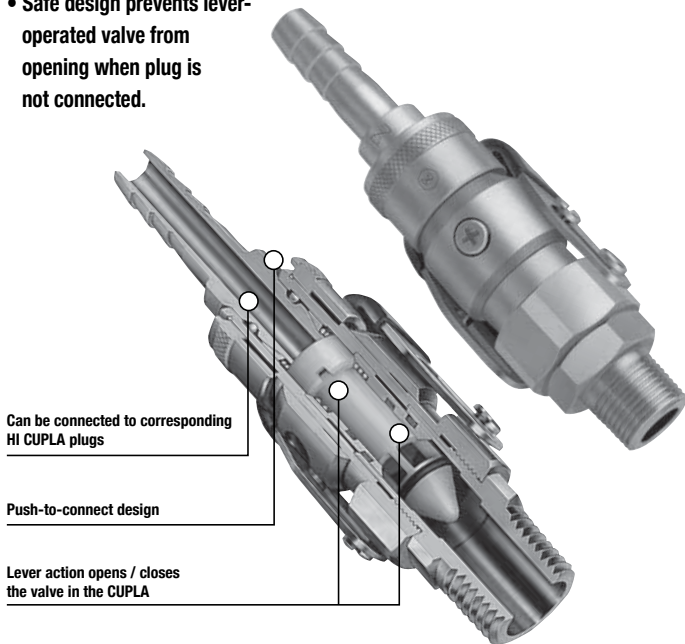

## How to Operate

<b>1</b>		Just push the plug into socket. (In this stage the valve of the socket is not open.)
<b>2</b>		Turning down the lever opens the valve and allows the fluid flow. (The turned-down lever works as a sleeve stopper and prevents disconnection.)
<b>3</b>		When the lever is pulled up, residual air pressure in the plug is purged without unpleasant popping noise and hose whip motion on disconnection. In this stage, the socket valve is still closed.

## Specifications

Body material	Brass (Chrome plated)			
Size (Thread)	1/4", 3/8", 1/2", 3/4"			
Pressure unit	MPa	kgf/cm <sup>2</sup>	bar	PSI
Working pressure	1.0	10	10	145
Seal material	Seal material	Mark	Working temperature range	Remarks
Working temperature range	Nitrile rubber	NBR (SG)	-20°C to +60°C	Standard material

## Maximum Tightening Torque

Nm {kgf·cm}

Model	PV-20SM	PV-30SM	PV-40SM	PV-400SM	PV-600SM
Torque	9 {92}	11 {112}	30 {306}	30 {306}	50 {510}

## Flow Direction



## Interchangeability

Models 20, 30 and 40 can be connected to plugs of HI CUPLA Models 10, 17, 20, 30 and 40. Interchangeable with each models of NUT CUPLA series and HI CUPLA series. Models 400 and 600 can be connected with plugs of HI CUPLA models 400, 600 and 800. Please see page 19 for "HI CUPLA Series Interchangeability".

## Minimum Cross-Sectional Area

(mm<sup>2</sup>)

Model	PV-20SM	PV-30SM	PV-40SM	PV-400SM	PV-600SM
Min. cross-sectional area	38	41	41	94	94

## Suitability for Vacuum

Not suitable for vacuum application in either connected or disconnected condition.

## Pressure - Flow Characteristics

[Test conditions] • Fluid : Air • Temperature : Room temperature

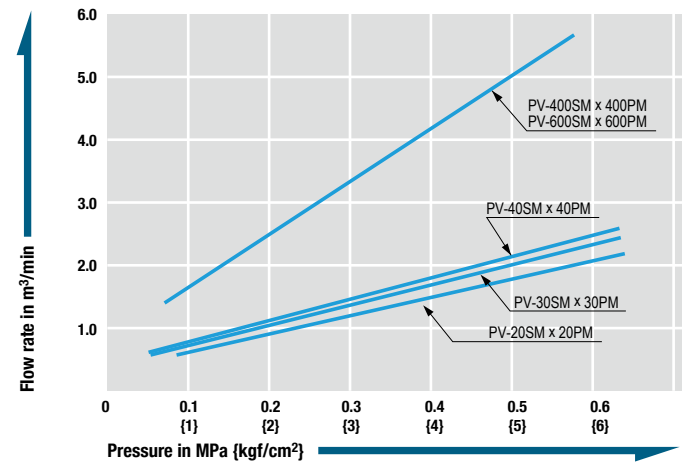

## Models and Dimensions

WAF : WAF stands for width across flats.

### Socket

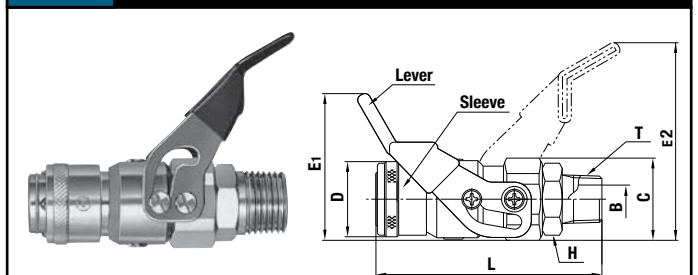



Model	Application (Thread)	Mass (g)	Dimensions (mm)							
			L	øD	E <sub>1</sub>	E <sub>2</sub>	H(WAF)	øC	T	øB
PV-20SM	Rc 1/4	225	(79)	26.5	(50.5)	(70)	Hex.22	29	R 1/4	7
PV-30SM	Rc 3/8	229	(80)	26.5	(50.5)	(70)	Hex.22	29	R 3/8	10
PV-40SM	Rc 1/2	235	(82)	26.5	(50.5)	(70)	Hex.22	29	R 1/2	14
PV-400SM	Rc 1/2	411	(94)	35	(61.5)	(82)	Hex.30	37.5	R 1/2	13
PV-600SM	Rc 3/4	424	(97)	35	(61.5)	(82)	Hex.30	37.5	R 3/4	18

Before use, please be sure to read "Safety Guide" described at the end of this book and "Instruction Sheet" that comes with the products.

For Low Pressure (Air)

# PURGE LINE CUPLA

Simple air line coupling manifold with residual pressure release function

<p>Working pressure</p>  <p>1.0 MPa {10 kgf/cm<sup>2</sup>}</p>	<p>Valve structure</p>  <p>One-way shut-off</p>	<p>Applicable fluid</p>  <p>Air</p>
--	--	--

**Residual pressure can be released by a mere lever turn. Very smooth connection/disconnection!**

- Single action, just push in the plug to connect regardless of internal pressure in socket.
- No unpleasant noise of air pressure discharge and no hose whip motion on disconnection for safety operation.
- Safe design – socket valve will not open or close unless plug is connected.
- Even after connection, a lever turn will open/close valve with perfect control of air flow or line shut-off.
- Enables simultaneous air supply to three outlets from a single air line.  
(A single outlet PURGE HI CUPLA is also available – see the pages of PURGE HI CUPLA for details.)

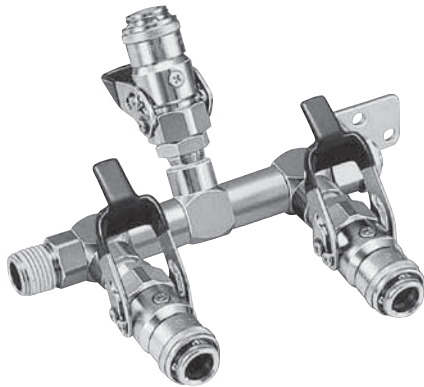

## Application Example

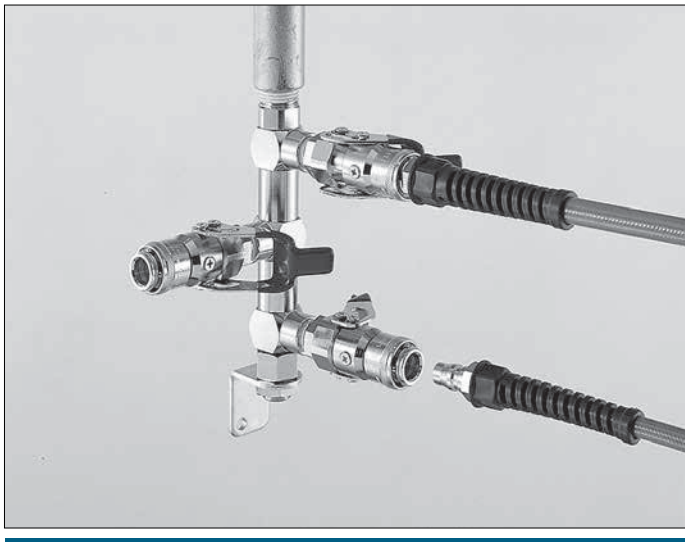

## Specifications

Body material	Brass (Chrome plated)			
Size	Inlet	R 1/2		
	Outlet	Socket (PV-30SM)		
Pressure unit	MPa	kgf/cm <sup>2</sup>	bar	PSI
Working pressure	1.0	10	10	145
Seal material	Seal material	Mark	Working temperature range	Remarks
Working temperature range	Nitrile rubber	NBR (SG)	-20°C to +60°C	Standard material

## Maximum Tightening Torque

Nm {kgf·cm}

Size (Thread)	1/2"
Torque	30 {306}

## Flow Direction

Fluid must run from the intake port to the outlet ports. Please refer to the flow directions (arrows) on the "Models and Dimensions."

## Interchangeability

Interchangeable with plugs of HI CUPLA models 10, 17, 20, 30 and 40. Interchangeable with each models of NUT CUPLA series and HI CUPLA series. Please see page 19 for "HI CUPLA Series Interchangeability".

## Minimum Cross-Sectional Area

(mm<sup>2</sup>)

Min. cross-sectional area	41
---------------------------	----

## Suitability for Vacuum

Not suitable for vacuum application in either connected or disconnected condition.

## Pressure - Flow Characteristics

[Test conditions] • Fluid : Air • Temperature : Room temperature

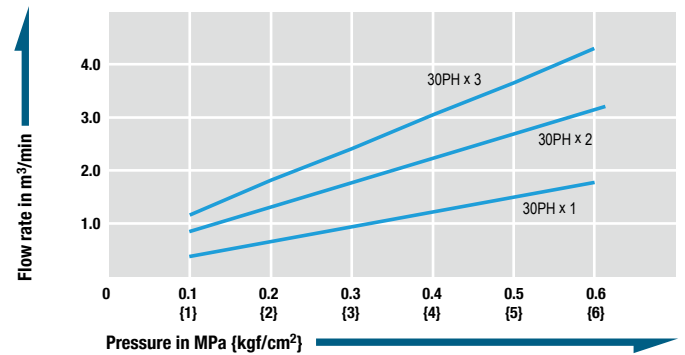

## Models and Dimensions

WAF : WAF stands for width across flats.

### Socket RE-PV-30 type (For three outlets)

Mass : 1,090 g

- Fluid must run in the direction of the arrow.

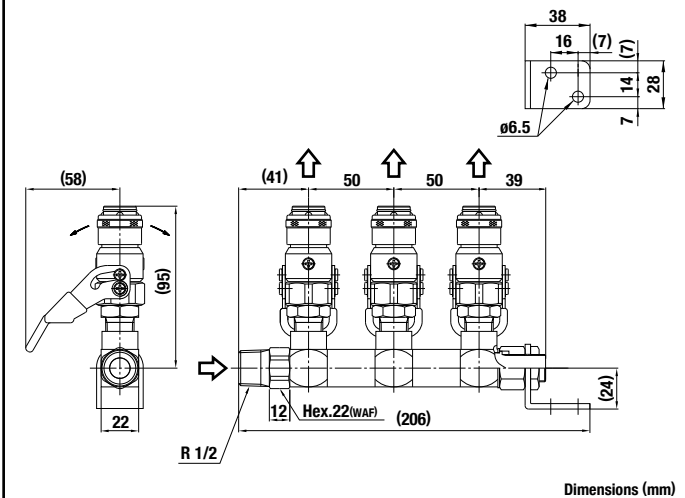





For Low Pressure (Air)

# ROTARY LINE CUPLA

Simple design air line couplings on free turn manifold

<p>Working pressure</p>  <p>1.5 MPa (15 kgf/cm<sup>2</sup>)</p>	<p>Valve structure</p>  <p>One-way shut-off</p>	<p>Applicable fluid</p>  <p>Air</p>
---	--	--

Each air outlet can be turned freely to any angle independently.

- Multiple outlets are available from single air supply source.
- Sideway air outlets are rotatable to any angle. Possible hose twists can be eliminated by the component couplings' swivel mechanism.
- Choose either RT type (2 outlets) or RE type (3 outlets) to suit your application.

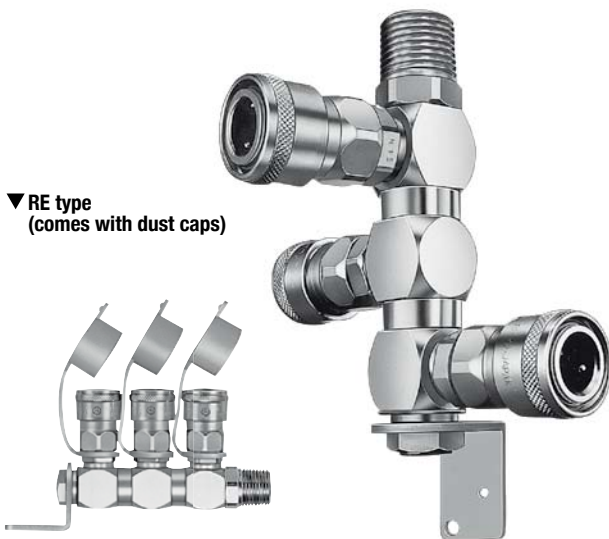
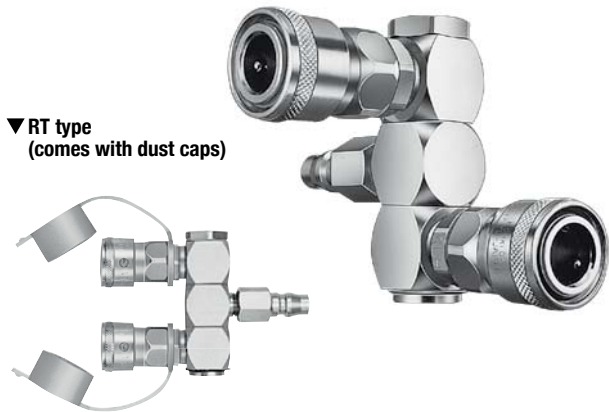

Specifications				
Body material	Body : Brass (Chrome plated), CUPLA : Steel (Chrome plated)			
Model	RT Type (for two branch lines)		RE Type (for three branch lines)	
Size	Inlet	HI CUPLA Plug 20PF	Inlet	R 1/2
	Outlet	2 sockets for HI CUPLA Model 20	Outlet	3 sockets for HI CUPLA Model 20
Pressure unit	MPa	kgf/cm <sup>2</sup>	bar	PSI
Working pressure	1.5	15	15	218
Seal material	Seal material	Mark	Working temperature range	Remarks
Working temperature range	Nitrile rubber	NBR (SG)	-20 °C to +60 °C	Standard material

\* The products come with dust caps.

Maximum Tightening Torque (RE Type)		Nm {kgf·cm}
Size (Thread)	1/2"	
Torque	30 {306}	

**Fluid Flow Direction**

Fluid must run from the inlet port to the outlet ports.

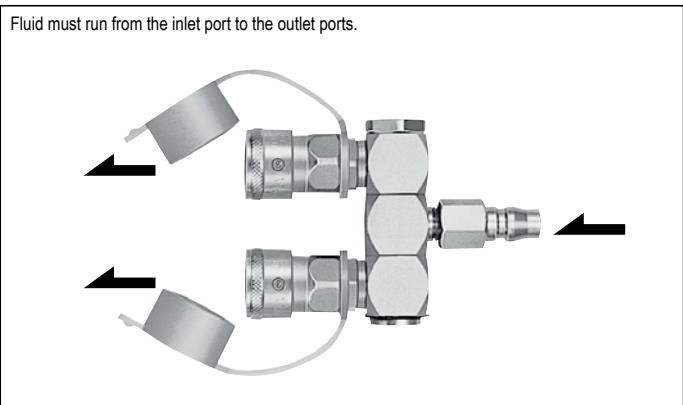

**Interchangeability**

Interchangeable with plugs of HI CUPLA models 10, 17, 20, 30 and 40.  
Interchangeable with each models of NUT CUPLA series and HI CUPLA series.  
Please see [page 19](#) for "HI CUPLA Series Interchangeability".

Minimum Cross-Sectional Area (mm <sup>2</sup> )		
Model	RT type	RE type
Minimum cross-sectional area	33	

**Suitability for Vacuum**

Not suitable for vacuum application in either connected or disconnected condition.

**Pressure - Flow Characteristics**

[Test conditions] • Fluid : Air • Temperature : Room temperature  
• Plug : 20PM (All the Socket valves are opened with 20PM)

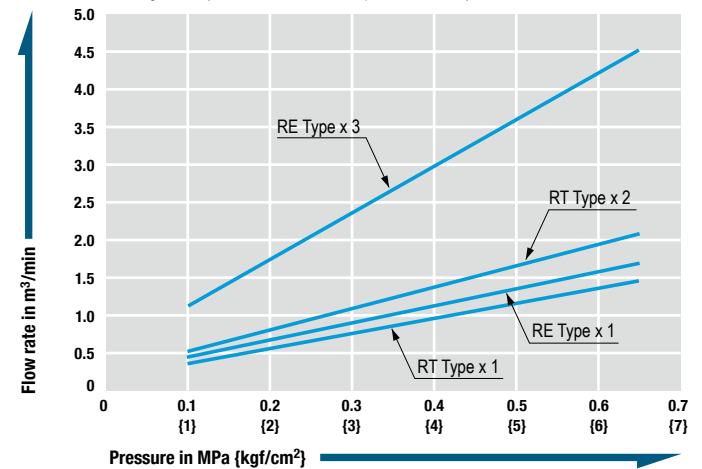

Models and Dimensions

**Socket RT type (For two outlets)**

Mass : 490 g

- Fluid must run in the direction of the arrow.
- The product comes with dust caps.

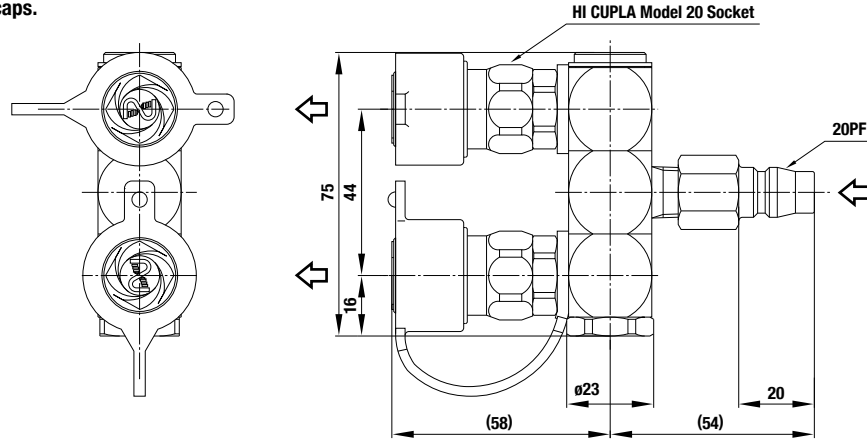

Dimensions (mm)

**Socket RE type (For three outlets)**

Mass : 660 g

- Fluid must run in the direction of the arrow.
- The product comes with dust caps.

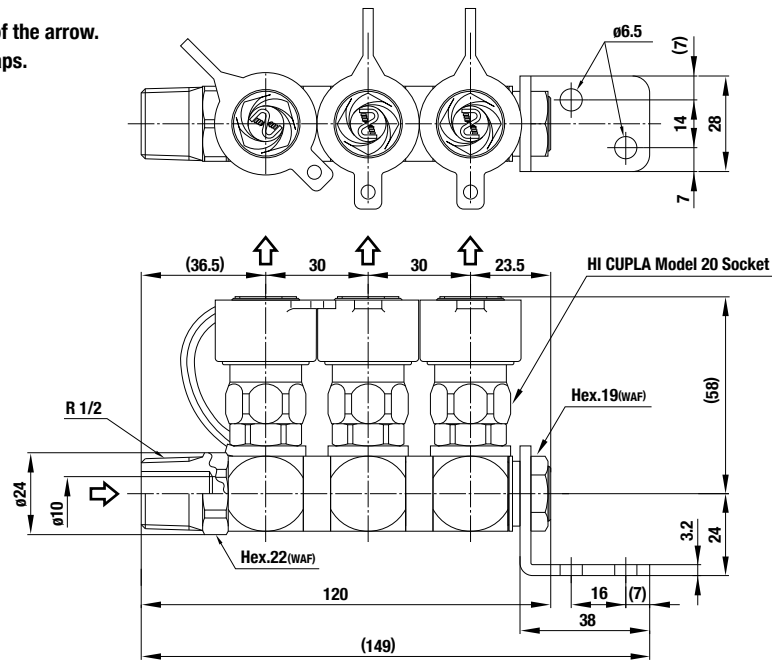

Dimensions (mm)

Application Example

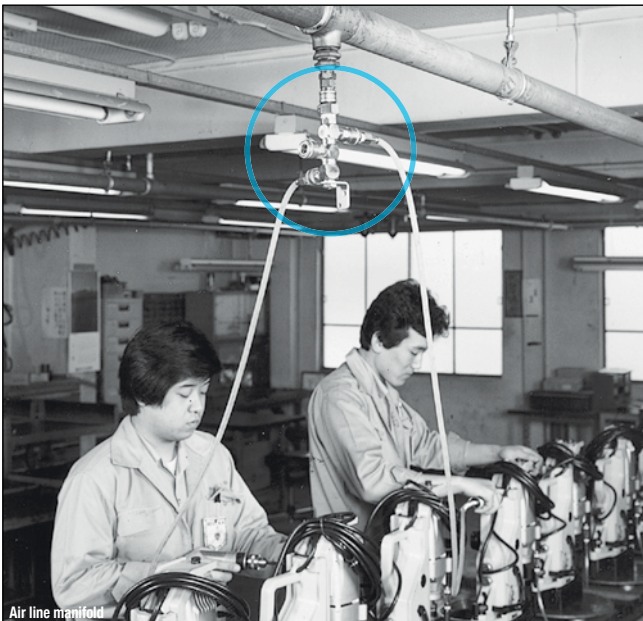

Air line manifold

Before use, please be sure to read "Safety Guide" described at the end of this book and "Instruction Sheet" that comes with the products.

For Low Pressure (Air)

# LINE CUPLA

## 200T Type, 200L Type, 200S Type

Simple design air line coupling on manifold

Working pressure



Valve structure



Applicable fluid



### Enables several air lines to be taken simultaneously from one supply line!

- Just push in the plug into socket for simple and secure connection.
- Multiple outlets are available from single air supply source.
- Choose from the 2-outlet type (Model 200T), the 5-outlet straight type (Model 200L) and the 5-outlet star type (Model 200S) to suit your application.



**200T type**  
(comes with dust caps)

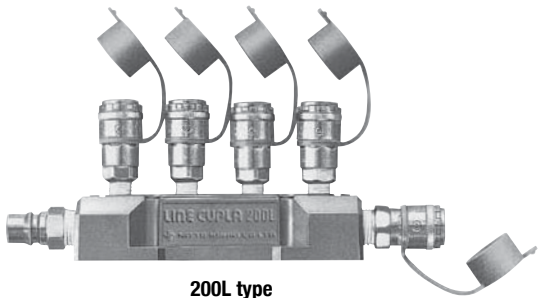

**200L type**  
(comes with an accessory 400SH and dust caps)



**200S type**  
(comes with an accessory 400SH and dust caps)

### Specifications

Body material	Body : Aluminum alloy, CUPLA : Steel (Chrome plated)			
Size	Inlet	200T Type : 20PM 200L Type / 200S Type : 400PM		
	Outlet	200T Type : 200-20SM 200L Type / 200S Type : 200-20SM, 40SM		
Pressure unit	MPa	kgf/cm <sup>2</sup>	bar	PSI
Working pressure	1.5	15	15	218
Seal material	Seal material	Mark	Working temperature range	Remarks
Working temperature range	Nitrile rubber	NBR (SG)	-20°C to +60°C	Standard material

\* The products come with dustproof caps.

### Flow Direction

Fluid must run from the inlet port to the outlet ports.

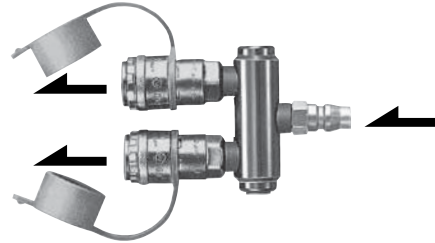

### Interchangeability

Interchangeable with plugs of HI CUPLA models 10, 17, 20, 30 and 40.  
Interchangeable with each models of NUT CUPLA series and HI CUPLA series.  
Please see [page 19](#) for "HI CUPLA Series Interchangeability".

### Minimum Cross-Sectional Area

(mm<sup>2</sup>)

Model	200T type, 200L type, 200S type
Minimum cross-sectional area	19

### Suitability for Vacuum

Not suitable for vacuum application in either connected or disconnected condition.

### Pressure - Flow Characteristics

[Test conditions] • Fluid : Air • Temperature : Room temperature

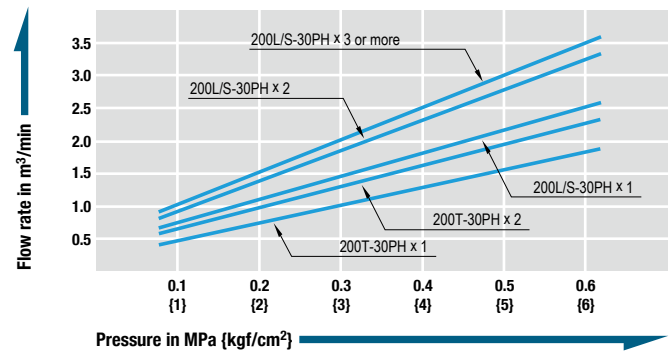

**Socket 200T type (For two outlets)**

Mass : 272 g

- Fluid must run in the direction of the arrow.
- The product comes with dust caps.

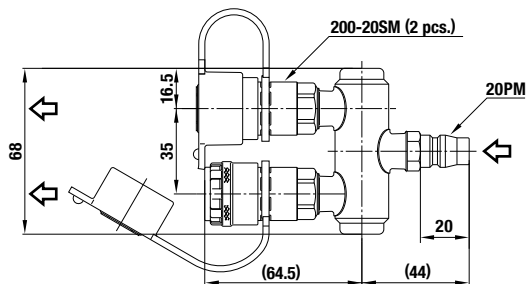

Dimensions (mm)

**Socket 200L type (For five outlets, in-line type)**

Mass : 890 g

- Fluid must run in the direction of the arrow.
- The product comes with dust caps.
- Accessory : 400SH

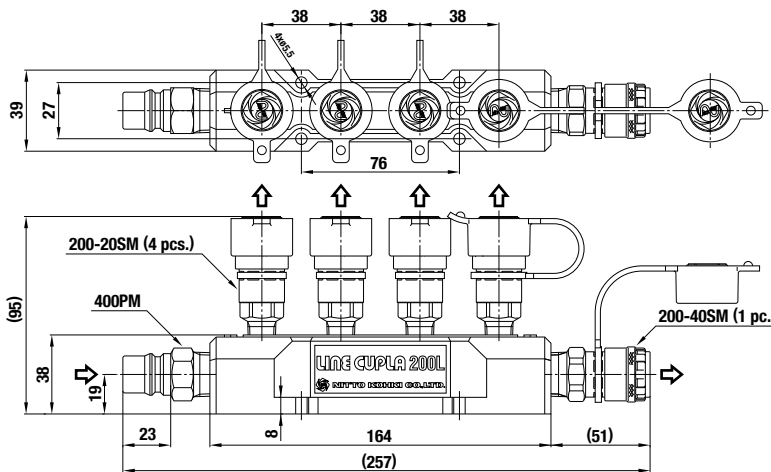

Dimensions (mm)

**Socket 200S type (For five outlets, star type)**

Mass : 769 g

- Fluid must run in the direction of the arrow.
- The product comes with dust caps.
- Accessory : 400SH

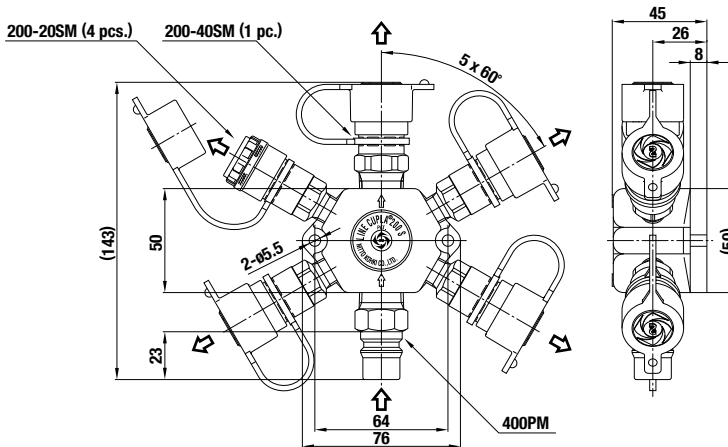

Dimensions (mm)

**Application Example**

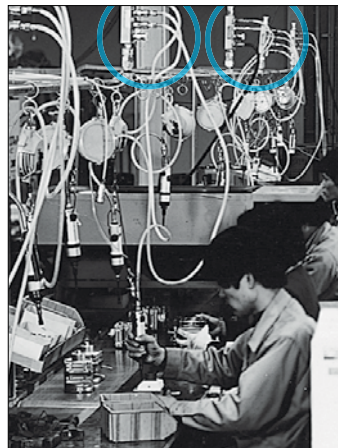
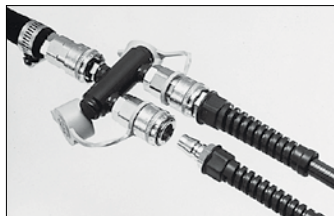

**Optional Items : PRESSURE GAUGE and DRAIN COCK**

"PRESSURE GAUGE" and "DRAIN COCK" are available as optional items to be mounted on LINE CUPLA 200. (See page 151)

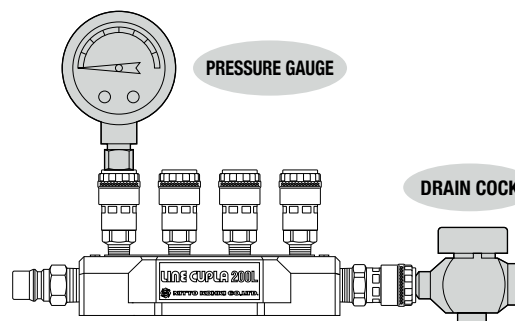

Appearance subject to change for improvement without notice.



For Low Pressure (Air)

# ROTARY FULL-BLOW LINE CUPLA

Free rotating branch air line coupling with low pressure loss & high flow rate

Working pressure



Valve structure



Applicable fluid



Each air outlet can be turned freely to any angle independently.

- Multiple outlets are available from single air supply source.
- Sideway air outlets are rotatable to any angle.
- Choose either RT type (2 outlets) or RE type (3 outlets) to suit your application.
- The flow rate increases by 40% to 50% over that of conventional CUPLA.
- During connection and disconnection, the valve is closed, enabling connection/disconnection under zero line pressure.
- When the sleeve of socket is returned to its original position, the purge mechanism releases the residual air pressure in the plug, eliminating unpleasant popping noise and hose whip motion on disconnection.
- Built-in sleeve lock mechanism prevents accidental disconnection of CUPLA, ensuring safe operation.
- The valve can be opened and closed while the socket and plug is connected.

FBH-RT Type  
(comes with dust caps)

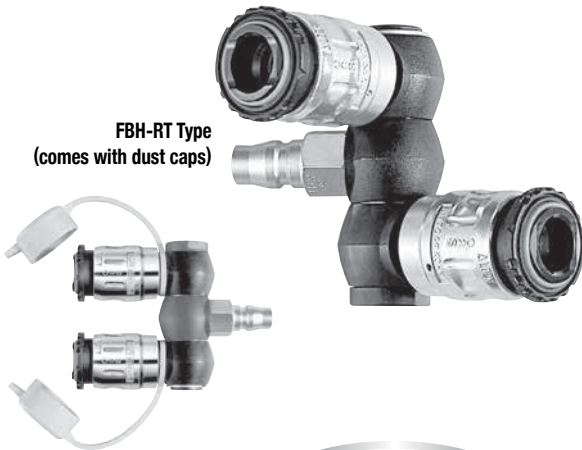

FBH-RE Type  
(comes with dust caps)

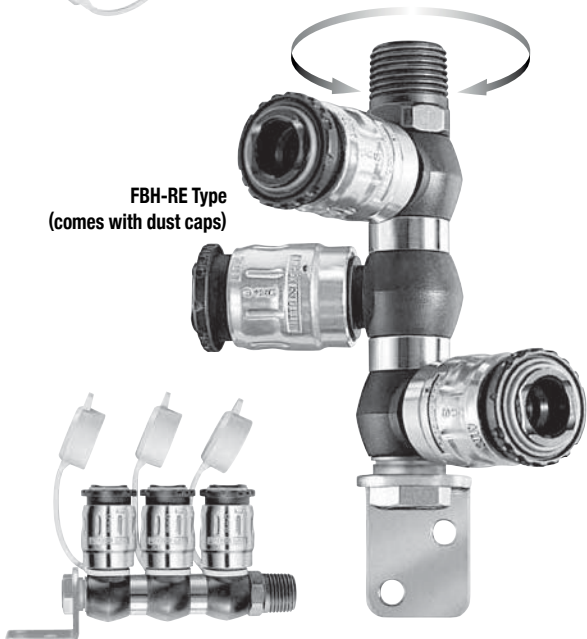

Specifications				
Body material	Zinc alloy			
Size	RT type (For two outlets)		RE type (For three outlets)	
	Inlet	Plug (20PFF)	Inlet	R 1/2
	Outlet	FULL-BLOW CUPLA	Outlet	FULL-BLOW CUPLA
Pressure unit	MPa	kgf/cm <sup>2</sup>	bar	PSI
Working pressure	1.5	15	15	218
Seal material	Seal material	Mark	Working temperature range	Remarks
Working temperature range	Nitrile rubber	NBR (SG)	-20 °C to +60 °C	Standard material

\* The product comes with dust caps.

Maximum Tightening Torque (FBH-RE Type)		Nm {kgf·cm}
Size (Thread)	1/2"	
Torque	30 {306}	

**Flow Direction**

Fluid must run from the inlet port to the outlet ports.

**Interchangeability**

Interchangeable with plugs of HI CUPLA models 10, 17, 20, 30 and 40.  
Interchangeable with each models of NUT CUPLA series and HI CUPLA series.  
Not interchangeable with some plugs of plastic HI CUPLA 250 (discontinued product).  
Please see page 19 for "HI CUPLA Series Interchangeability".

Minimum Cross-Sectional Area (mm <sup>2</sup> )		
Model	FBH-RT	FBH-RE
Minimum cross-sectional area	44	44

**Suitability for Vacuum**

Not suitable for vacuum application in either connected or disconnected condition.

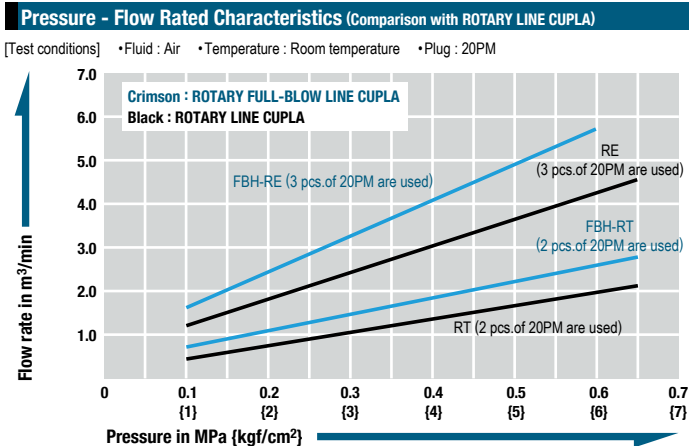

Models and Dimensions

**Socket FBH-RT type (For two branch lines)**

- Inlet : 1/4" HI CUPLA (20PFF)
- Outlet : FULL-BLOW CUPLA
- Mass : 358 g
- Fluid must run in the direction of the arrow.

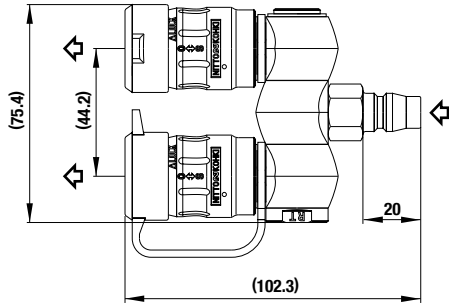

• The product comes with dust caps.

Dimensions (mm)

**Socket FBH-RE type (For three branch lines)**

- Inlet : R 1/2
- Outlet : FULL-BLOW CUPLA
- Mass : 527 g
- Fluid must run in the direction of the arrow.

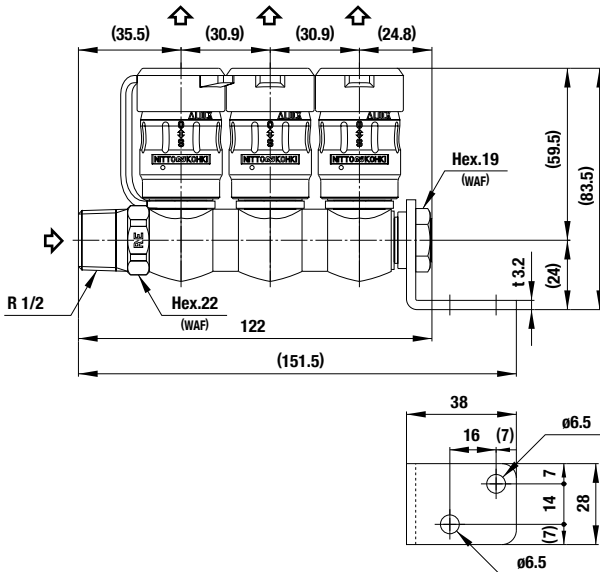

• The product comes with dust caps.

Dimensions (mm)

Features of ROTARY FULL-BLOW LINE CUPLA

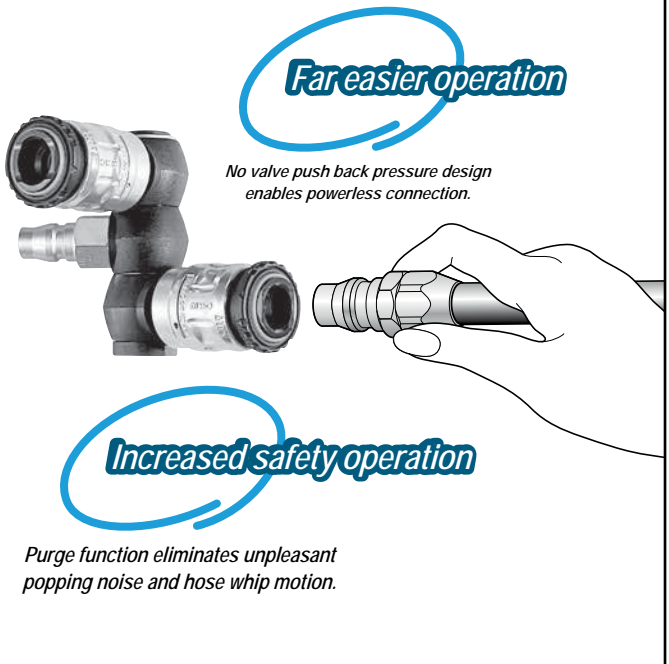
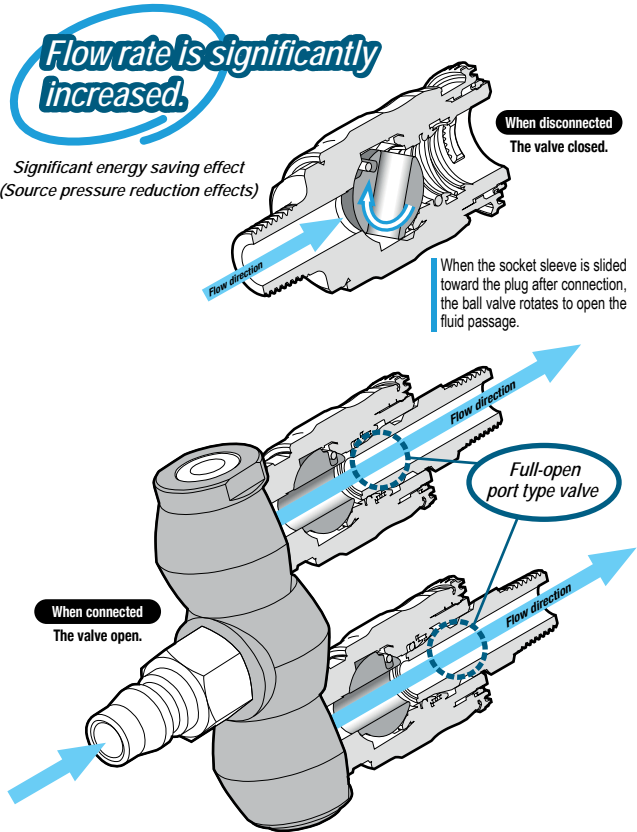

How It Works

1. Open the valve

Only after connection with the plug, you can slide the socket sleeve B toward the plug in order to open the built-in valve. Full flow path is then obtained.

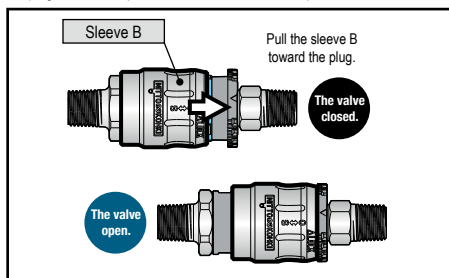

2. Lock the sleeve

Rotate the flange counterclockwise to lock the sleeve B. Without unlocking the plug you cannot disconnect.

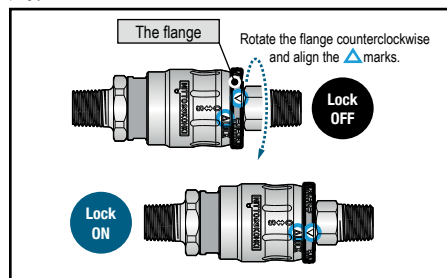

3. Purge the residual air

To disconnect the plug, first turn the flange back to its original position for unlocking and then pull the sleeve B back to the original position. The built-in valve will be closed to purge the residual air pressure.

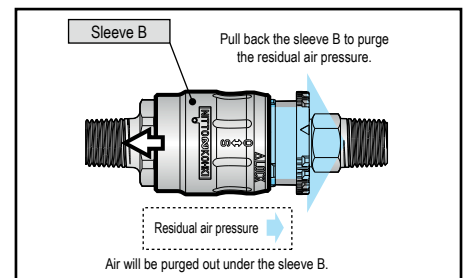



Before use, please be sure to read "Safety Guide" described at the end of this book and "Instruction Sheet" that comes with the products.

For Low Pressure

# HI CUPLA ACE

Lightweight plastic coupling with automatic safety lock for air line applications

<p>Working pressure</p>  <p>1.5 MPa (15 kgf/cm<sup>2</sup>)</p>	<p>Valve structure</p>  <p>One-way shut-off</p>	<p>Applicable fluids</p>  <p>Air Water</p>
---	--	---

The weight is merely a quarter of steel HI CUPLA's and smooth push-in connection is achieved. Sleeve lock mechanism for safety operation.

- Pressure ratings comparable to steel CUPLA.
- A built-in "lock mechanism" locks the sleeve upon connection, thus prevents accidental disconnection.
- Just push plug into socket for simple connection.
- The weight is a quarter of steel HI CUPLA for easy handling.
- Can be used for air and water.
- Air flows in either direction from plug or from socket side when coupled.
- Plug and socket with hose guard nut are also available (see page 64 of NK CUPLA HOSE / NK CUPLA COIL HOSE for details).

Specifications							
Body material		Engineering plastics (PBT, POM)					
Size	Thread and hose barb	1/4", 3/8" / 1/4", 3/8"					
	PN type, SN type (PNG type, SNG type)	For ø5 mm x ø8 mm, ø6 mm x ø9 mm, ø6.5 mm x ø10 mm, ø8 mm x ø12 mm, ø8.5 mm x ø12.5 mm polyurethane hose					
	T type	HA-T type • Inlet : 20P-PLA • Outlet : HA-65S x 2					
Working pressure	MPa	1.5	1.0 for plastic plug and Model HA-T				
	kgf/cm <sup>2</sup>	15	10 for plastic plug and Model HA-T				
	bar	15	10 for plastic plug and Model HA-T				
	PSI	218	145 for plastic plug and Model HA-T				
Seal material	Nitrile rubber	Mark	NBR (SG)	Working temperature range	-20 °C to +60 °C	Remarks	Standard material

Tightening Torque Range		Nm {kgf·cm}			
Model		20/30SM 20/30PM	50/60/65SN 50/60/65PN	80/85SN 80/85PN	20PFF
Torque		2.5 to 3.0 {26 to 31}	1.6 to 2.0 {16 to 20}	2.2 to 2.8 {22 to 29}	2.0 to 2.5 {20 to 25}

**Flow Direction**

Fluid flow can be bi-directional when socket and plug are connected.

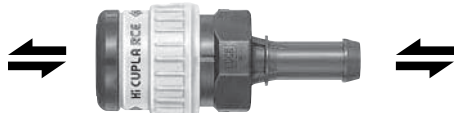

**Interchangeability**

Interchangeable with HI CUPLA models 10, 17, 20, 30 and 40.  
Interchangeable with each models of NUT CUPLA series and HI CUPLA series (except models 400, 600, and 800).  
Please see page 19 for "HI CUPLA Series Interchangeability".

**Suitability for Vacuum**

Not suitable for vacuum application in either connected or disconnected condition.

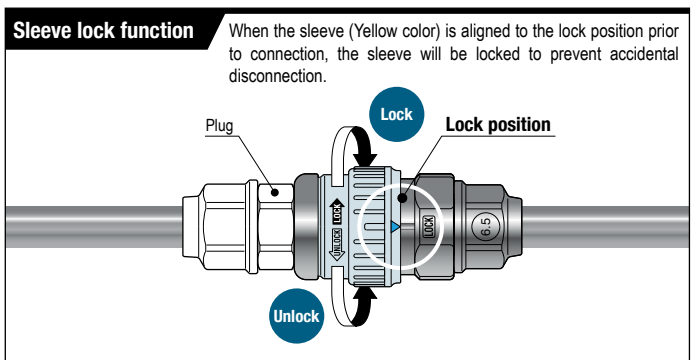
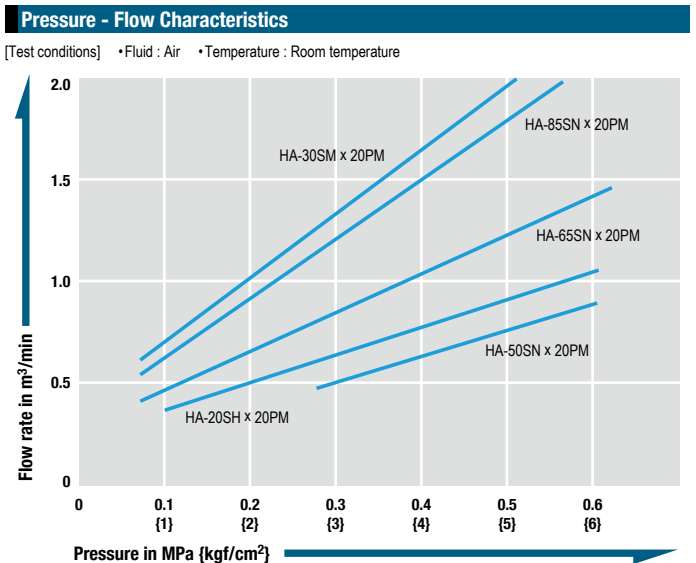

Models and Dimensions

**Plug PH type (Plastic plug / Hose barb)**

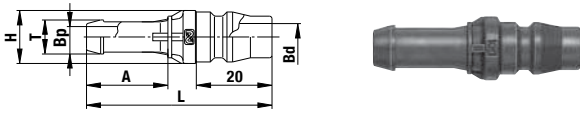

Model	Application (Hose)	Mass (g)	Dimensions (mm)					
			L	øH	A	øT	øBp	øBd
20PH-PLA	1/4"	3	49	14	21.5	9	5.5	7
30PH-PLA	3/8"	4	52	16	23.5	11.5	7.5	7

**Plug PM type (Plastic plug / Male thread)**

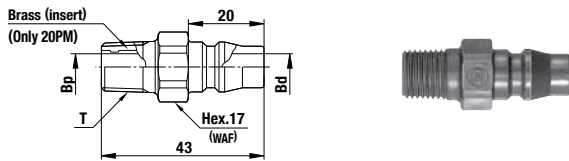

Model	Application (Thread)	Mass (g)	Dimensions (mm)		
			T	øBp	øBd
20PM-PLA	Rc 1/4	8	R 1/4	7.1	7.4
30PM-PLA	Rc 3/8	6	R 3/8	10	7.4

**Plug PN type (Plastic plug / For urethane hose connection)**

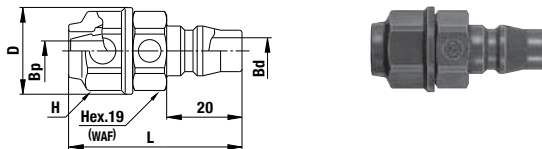

Model	Application (Hose)	Mass (g)	Dimensions (mm)				
			L	øH	Hp(WAF)	øBp	øBd
50PN-PLA	ø5 mm x ø8 mm	9	(46)	23	Hex.19	4	7
60PN-PLA	ø6 mm x ø9 mm	9	(46)	23	Hex.19	4.7	7
65PN-PLA	ø6.5 mm x ø10 mm	9	(46)	23	Hex.19	5.3	7
80PN-PLA	ø8 mm x ø12 mm	12	(48.5)	26	Hex.22	6.5	7
85PN-PLA	ø8.5 mm x ø12.5 mm	12	(48.5)	26	Hex.22	7	7

**Plug PFF type (Plastic plug / Parallel female thread)**

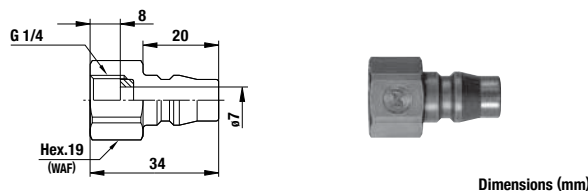

Model	Application (Thread)	Mass (g)
20PFF-PLA	G 1/4	6

**Plug PNG type (Plastic plug / For hose with hose guard nut connection)**

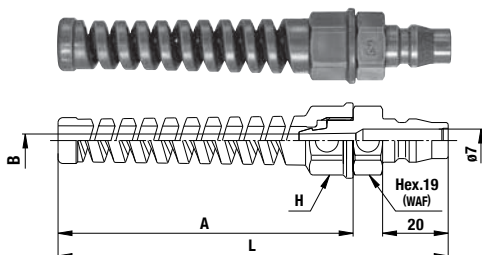

Model	Application (Hose)	Mass (g)	Dimensions (mm)			
			L	H(WAF)	A	øB
50PNG-PLA	ø5 mm x ø8 mm	14	(119)	Hex.19	(90)	4
65PNG-PLA	ø6.5 mm x ø10 mm	15	(119)	Hex.19	(90)	5.3
85PNG-PLA	ø8.5 mm x ø12.5 mm	17	(119)	Hex.22	(90)	7

**Socket SH type (Hose barb)**

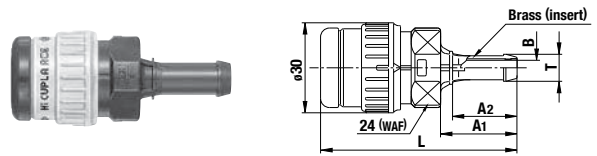

Model	Application (Hose)	Mass (g)	Dimensions (mm)				
			L	A1	A2	øT	øB
HA-20SH	1/4"	26	(65.5)	25.5	21.5	9	5
HA-30SH	3/8"	28	(68)	28	23.5	11.5	7

**Socket SM type (Male thread)**

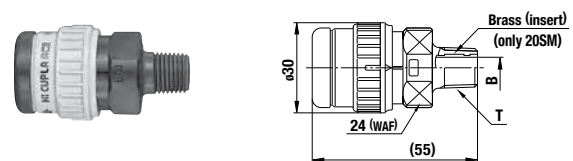

Model	Application (Thread)	Mass (g)	Dimensions (mm)	
			T	øB
HA-20SM	Rc 1/4	27	R 1/4	7.1
HA-30SM	Rc 3/8	26	R 3/8	8

**Socket SN type (For urethane hose connection)**

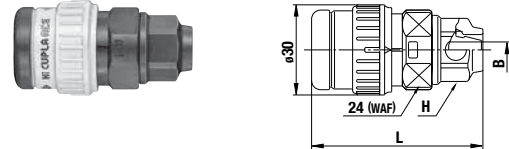

Model	Application (Hose)	Mass (g)	Dimensions (mm)		
			L	H(WAF)	øB
HA-50SN	ø5 mm x ø8 mm	27	(57)	Hex.19	4
HA-60SN	ø6 mm x ø9 mm	27	(57)	Hex.19	4.7
HA-65SN	ø6.5 mm x ø10 mm	27	(57)	Hex.19	5.3
HA-80SN	ø8 mm x ø12 mm	29	(59.5)	Hex.22	6.5
HA-85SN	ø8.5 mm x ø12.5 mm	29	(59.5)	Hex.22	7

**Socket T type (For two branch lines)**

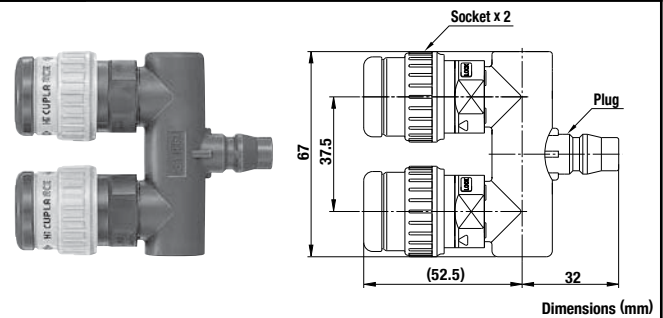

Model	Inlet / Outlet	Mass (g)
HA-T	20P-PLA / HA-65S x 2	73

**Socket SNG type (For hose with hose guard nut connection)**

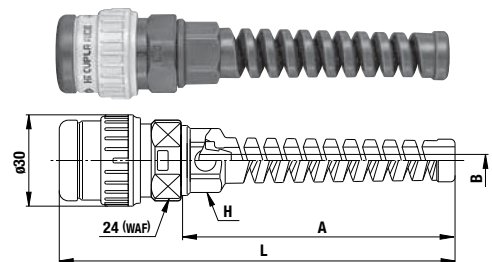



Model	Application (Hose)	Mass (g)	Dimensions (mm)			
			L	H(WAF)	A	øB
HA-50SNG	ø5 mm x ø8 mm	31	(130)	Hex.19	(90)	4
HA-65SNG	ø6.5 mm x ø10 mm	33	(130)	Hex.19	(90)	5.3
HA-85SNG	ø8.5 mm x ø12.5 mm	35	(130)	Hex.22	(90)	7



For Low Pressure (Air)

# ROTARY PLUG

For pneumatic tools and devices

<b>Working pressure</b>  1.5 MPa (15 kgf/cm <sup>2</sup> )	<b>Valve structure</b>  One-way shut-off	<b>Applicable fluid</b>  Air
---	---	---

**Newly developed rotary function allows 360° swivelling!**  
**Big improvement for handling of pneumatic tools!**

- Rotary neck plug for hose connection to pneumatic tools and pneumatic devices.
- Fits at 45° angle to the tool eliminating annoying offset load caused by connected hose.
- Ideal compact design enables optimum workability by simple body structure. Now far lighter and smaller than conventional models.
- New dust-proof design for increased durability.
- For air tackers, nailers, impact wrenches and other pneumatic tools.

■ Comparison by appearance

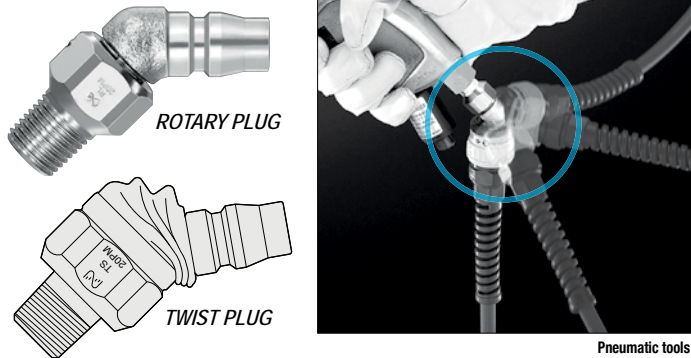

Specifications				
Body material	Steel (Nickel plated)			
Size (Thread)	1/4", 3/8"			
Pressure unit	MPa	kgf/cm <sup>2</sup>	bar	PSI
Working pressure	1.5	15	15	218
Seal material	Seal material	Mark	Working temperature range	Remarks
Working temperature range	Nitrile rubber	NBR (SG)	-20°C to +80°C	Standard material

Maximum Tightening Torque		Nm {kgf·cm}
Size (Thread)	1/4"	3/8"
Torque	14 {143}	22 {224}

**Flow Direction**

Fluid flow can be bi-directional when socket and plug are connected.

**Interchangeability**

Interchangeable with sockets of HI CUPLA models 10, 17, 20, 30 and 40. Interchangeable with each models of NUT CUPLA series and HI CUPLA series (except models 400, 600, and 800). Please see page 19 for "HI CUPLA Series Interchangeability".

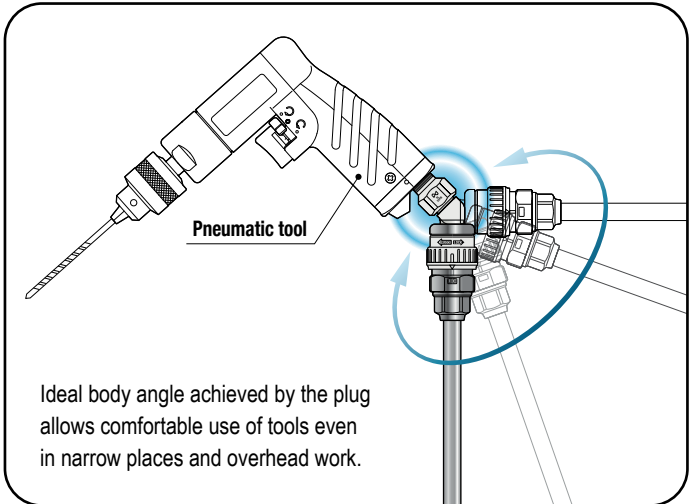

Models and Dimensions

**Plug PM type (Male thread)**

Model	Application (Thread)	Mass (g)	Dimensions (mm)		
			L	D	T
RL-20PM	Rc 1/4	52	(52.1)	(34.1)	R 1/4
RL-30PM	Rc 3/8	73	(50.8)	(32.8)	R 3/8

WAF : WAF stands for width across flats.

**Plug Model RL-20PFF type (Female thread)**

● Application (Thread) : G 1/4  
 ● Mass : 57 g

Dimensions (mm)

Before use, please be sure to read "Safety Guide" described at the end of this book and "Instruction Sheet" that comes with the products.

For Low Pressure (Air)

# TWIST PLUG

For pneumatic tools and devices

Working pressure



Valve structure



Applicable fluid



**Eliminates hose twisting, kinking, or bending! Greatly improves working efficiency!**

- A plug with a free twisting neck for hose connections to pneumatic tools and devices.
- Free angle control (max.70° flexible) provides comfortable job positions, even in narrow spaces or with overhead works.
- The flexible part is reinforced with self-lubricating plastics to give smooth bending action and excellent durability.
- Dust protector over the flexible part prevents dirt and swarf from entering.

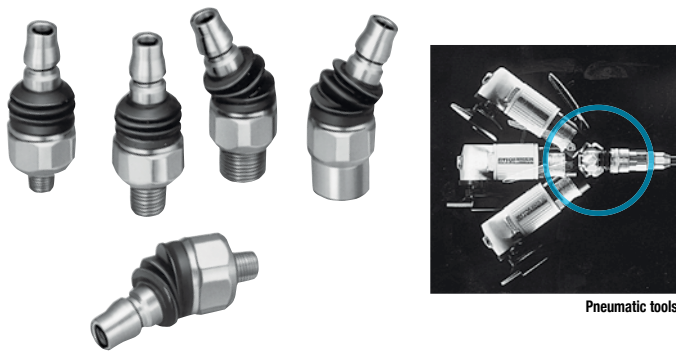

## Specifications

Body material	Steel (Nickel plated)			
Size (Thread)	1/8", 1/4", 3/8"			
Pressure unit	MPa	kgf/cm <sup>2</sup>	bar	PSI
Working pressure	1.0	10	10	145
Seal material	Seal material	Mark	Working temperature range	Remarks
Working temperature range	Nitrile rubber	NBR (SG)	-20°C to +60°C	Standard material

## Maximum Tightening Torque

Nm {kgf·cm}

Size (Thread)	1/8"	1/4"	3/8"
Torque	7 {71}	14 {143}	22 {224}

## Flow Direction

Fluid flow can be bi-directional when socket and plug are connected.

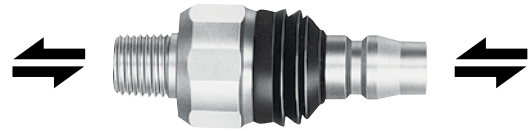

## Interchangeability

Interchangeable with sockets of HI CUPLA models 10, 17, 20, 30 and 40. Interchangeable with each models of NUT CUPLA series and HI CUPLA series (except models 400, 600, and 800). Please see page 19 for "HI CUPLA Series Interchangeability".

## Suitability for Vacuum

Not suitable for vacuum application in either connected or disconnected condition.

## Minimum Cross-Sectional Area

(mm<sup>2</sup>)

Model	TS-10PM	TS-20PM	TS-30PM	TS-20PFF
Min. cross-sectional area	12.5	38.5	38.5	38.5

## Pressure - Flow Characteristics

[Test conditions] • Fluid : Air • Temperature : Room temperature

(S) is a state of straight.  
(B) is a state of bending.

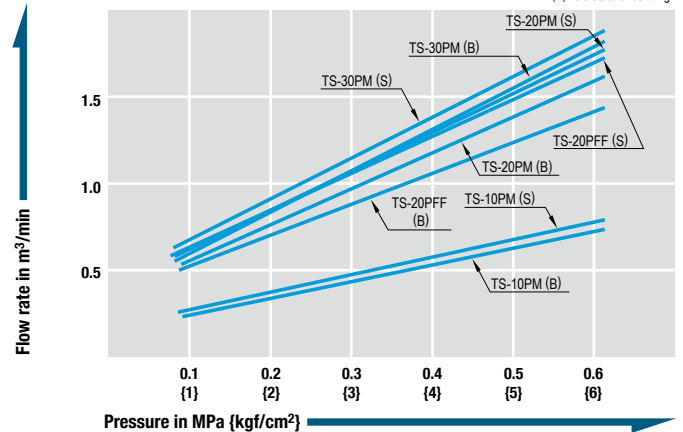

## Models and Dimensions

WAF : WAF stands for width across flats.

### Plug PM type (Male thread)

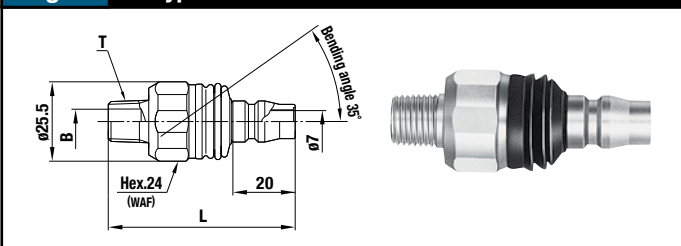

Model	Application (Thread)	Mass (g)	Dimensions (mm)		
			L	øB	T
TS-10PM	Rc 1/8	59	(57.5)	4	R 1/8
TS-20PM	Rc 1/4	59	(60)	8	R 1/4
TS-30PM	Rc 3/8	65	(60)	10	R 3/8

### Plug Model TS-20PFF (Female thread)

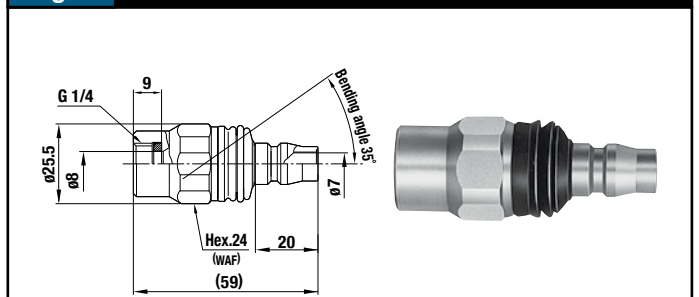



- Application (Thread) : G 1/4
  - Mass : 77 g
- Dimensions (mm)

For Low Pressure (Air)

# PURGE PLUG

For air lines with purge mechanism

Working pressure <b>1.0</b> 1.0 MPa (10 kgf/cm <sup>2</sup> )	Valve structure  Purge valve	Applicable fluid  Air
--	---	--

Eliminates unpleasant popping noise and hose whip motion when CUPLA is disconnected.

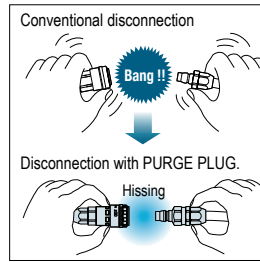

- When the CUPLA is disconnected, the pressure left in the plug side hose is released gradually without unpleasant popping noise and hose whip motion.
- Unique design of air purge system enables the residual pressure release quickly and quietly.
- A unique but simple purge valve design is good for long and repeated use.
- The function is assured even under a high supply pressure or with a long hose.

Note: This product is not a check valve to totally stop the air flow.



Specifications				
Body material	Steel (Chrome plated)			
Size	1/4", 3/8", 1/2" / ø6.5 mm x ø10 mm, ø8.5 mm x ø12.5 mm hose			
Pressure unit	MPa	kgf/cm <sup>2</sup>	bar	PSI
Working pressure	1.0	10	10	145
Seal material	Seal material	Mark	Working temperature range	Remarks
Working temperature range	Nitrile rubber	NBR (SG)	-20°C to +60°C	Standard material

Tightening Torque Range		Nm {kgf·cm}
Torque	9 to 11 {92 to 112}	

To mount on urethane hose, slide it over to the hose barb and tighten the nut until it is flush against the hose barb base. It is recommended that grease is applied to the inside of the nut (threaded part and hose contact part) for easy tightening.

### Flow Direction

Fluid must run from socket to plug.

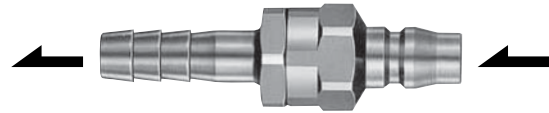

### Interchangeability

Interchangeable with sockets of HI CUPLA models 10, 17, 20, 30 and 40. Interchangeable with each models of NUT CUPLA series and HI CUPLA series (except models 400, 600, and 800). Please see page 19 for "HI CUPLA Series Interchangeability".

### Minimum Cross-Sectional Area (mm<sup>2</sup>)

Model	PV-20PH	PV-30PH	PV-40PH	PV-65PN	PV-85PN
Min. cross-sectional area	19.6	44.1	50.4	22.0	44.1

### Suitability for Vacuum

Not suitable for vacuum application in either connected or disconnected condition.

### Pressure - Flow Characteristics

[Test conditions] • Fluid : Air • Temperature : Room temperature

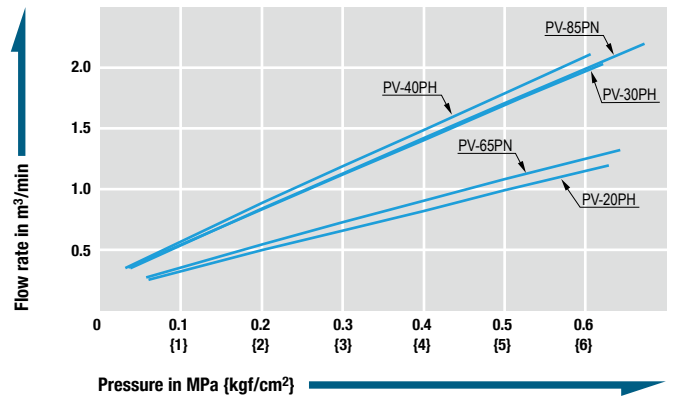

### Models and Dimensions

WAF : WAF stands for width across flats.



Model	Application (Hose)	Mass (g)	Dimensions (mm)			
			L	A	øB	øT
PV-20PH	1/4"	59	(70)	28	5	8.4
PV-30PH	3/8"	62	(74)	32	7.5	11.3
PV-40PH	1/2"	76	(77)	35	9	14.8

Model	Application (Hose)	Mass (g)	Dimensions (mm)			
			L	A	øB	T(WAF)
PV-65PN	ø6.5 mm x ø10 mm	71	(59)	17	5.3	Hex.17
PV-85PN	ø8.5 mm x ø12.5 mm	78	(61)	19	7.5	Hex.19

# For Low Pressure (Air)

# ANTI-VIBRATION PLUG HOSE

Plug hose for vibrating and percussive air tools

Working pressure	Valve structure	Applicable fluid
 1.5 MPa {15 kgf/cm <sup>2</sup> }	 One-way shut-off	 Air

## Protects the CUPLA from shock generated by vibrating tools and impact tools.

- Optimizes life and prevents wear of “CUPLA” by absorbing strong shocks generated by connected vibrating tools.
- Prevents hard-to-notice flow reduction caused by “CUPLA” wear under continuous vibration.
- Flexible rubber hose allows free and wide range of tool motion.



Specifications				
Applicable fluid	Air			
Model	SHA-3-2R	SHA-3-3R		
Size (Thread)	R 1/4"	R 3/8"		
Inlet (Plug)	HI CUPLA Plug 30PH			
Pressure unit	MPa	kgf/cm <sup>2</sup>	bar	PSI
Working pressure	1.5	15	15	218
Air hose	Rubber hose for air			
Overall length	320 mm			
Minimum bend radius	135 mm			

Maximum Tightening Torque		Nm {kgf·cm}
Size (Thread)	R 1/4	R 3/8
Torque	14 {143}	22 {224}

**Interchangeability**  
Interchangeable with sockets of HI CUPLA models 10, 17, 20, 30 and 40.  
Interchangeable with each models of NUT CUPLA series and HI CUPLA series (except models 400, 600, and 800).  
Please see [page 19](#) for “HI CUPLA Series Interchangeability”.

**Application**

Suitable for air tools such as impact wrenches used in car maintenance or metalworking industries, and tackers, nailers or concrete breakers in the construction industry, that commonly cause incessant vibrations.

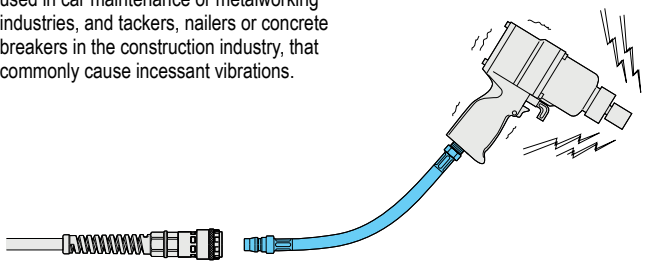

As an intermediate connection hose between “CUPLA” and a vibrating air tool.

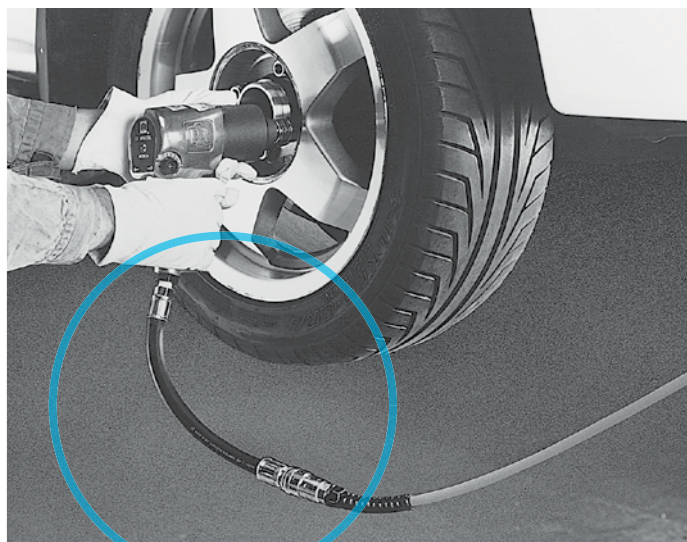





For Low Pressure (Air)

# DUSTER CUPLA

Air line coupling with air blower function

<p>Working pressure</p>  <p>1.0 MPa (10 kgf/cm<sup>2</sup>)</p>	<p>Valve structure</p>  <p>One-way shut-off</p>	<p>Applicable fluid</p>  <p>Air</p>
---	--	--

## Three functions in one: connection, air blow, hose twist release ! Dust blow without detaching the tool !

- HI CUPLA comes with compact air blow function.
- Improves job efficiency by air blow with tool still connected to hose.
- Ball bearing swivel mechanism prevents hose twist and relieves tension on operator's hand.
- Special design of air blow button switch is free from in line air pressure – no hard press down required.
- Also simple is routine water drain from air line before starting daily work.

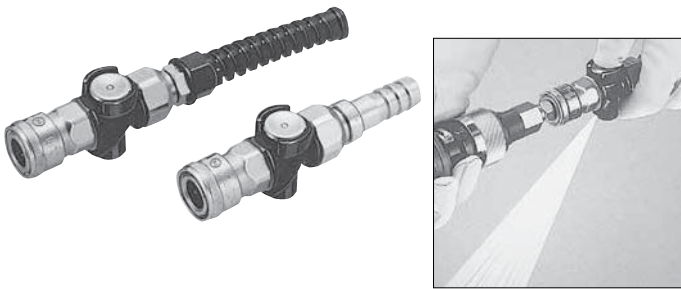

Photo shows simulated air flow.

Specifications				
Body material	Body : Aluminum alloy, CUPLA : Steel (Chrome plated)			
Size	For 1/4", 3/8", 1/2" hose For ø6.5 x ø10 mm, ø8.5 x ø12.5 mm polyurethane hose			
Pressure unit	MPa	kgf/cm <sup>2</sup>	bar	PSI
Working pressure	1.0	10	10	145
Seal material	Seal material	Mark	Working temperature range	Remarks
Working temperature range	Nitrile rubber	NBR (SG)	-20°C to +60°C	Standard material

Tightening Torque Range		Nm {kgf·cm}	
Model	65PNG	85PNG	
Torque	5 to 6 {51 to 61}	7 to 8 {71 to 82}	

To mount on urethane hose, slide it over to the hose barb and tighten the nut until it is flush against the hose barb base. It is recommended that grease is applied to the inside of the nut (threaded part and hose contact part) for easy tightening.

**Flow Direction**

Fluid must run from socket to plug.

**Interchangeability**

Interchangeable with plugs of HI CUPLA models 10, 17, 20, 30 and 40.  
Interchangeable with each models of NUT CUPLA series and HI CUPLA series.  
Please see page 19 for "HI CUPLA Series Interchangeability".

**Suitability for Vacuum**

Not suitable for vacuum application in either connected or disconnected condition.

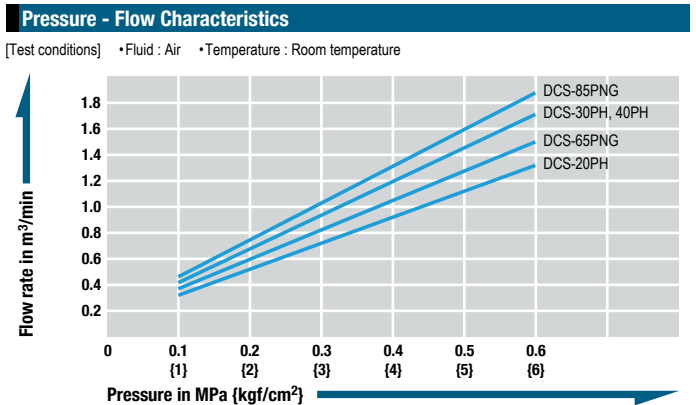

### Models and Dimensions

WAF : WAF stands for width across flats.

#### Socket PH type (Hose barb)

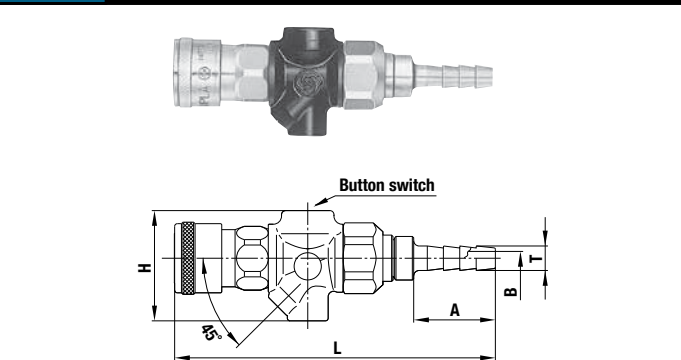

Model	Application (Hose)	Mass (g)	Dimensions (mm)				
			L	A	H	øB	øT
DCS-20PH	1/4"	168	(117.9)	30	40.5	5	9
DCS-30PH	3/8"	171	(121.9)	34	40.5	7.5	11.3
DCS-40PH	1/2"	193	(123.9)	36	40.5	7.5	15

#### Socket PNG type (For hose with hose guard nut connection)

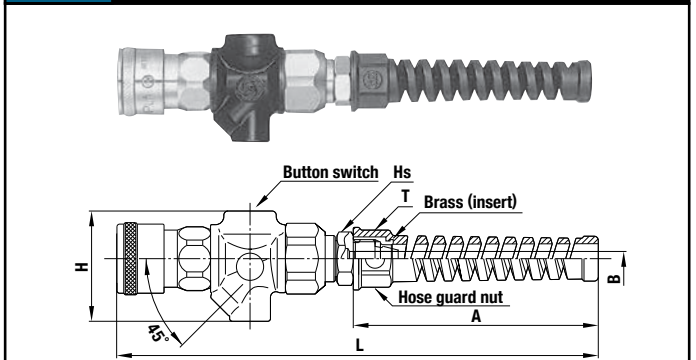

Model	Application (Hose)	Mass (g)	Dimensions (mm)						
			L	A	H	øB	H(WAF)	T(WAF)	
DCS-65PNG	ø6.5 mm x ø10 mm	176	(176.9)	90	40.5	5.3	Hex.17	Hex.19	
DCS-85PNG	ø8.5 mm x ø12.5 mm	185	(176.9)	90	40.5	7.5	Hex.19	Hex.22	

Before use, please be sure to read "Safety Guide" described at the end of this book and "Instruction Sheet" that comes with the products.

For Low Pressure (Air)

# NK CUPLA HOSE NK CUPLA COIL HOSE

Couplings with polyurethane hose for air lines

Working pressure	Valve structure	Applicable fluid
 0.7 MPa (7 kgf/cm <sup>2</sup> )	 One-way shut-off	 Air
 1.0 MPa (10 kgf/cm <sup>2</sup> )		

HI CUPLA ACE sockets with polyurethane hoses are now standard stock items.  
Push-to-connect design for quick piping.

- The HI CUPLA ACE socket is mounted on pliable polyurethane hose featuring excellent durability and wear resistant with hose guard nut to prevent possible kinking.
- Plastic socket will cause minimum risk of damage even in contact with tools or equipment.
- Air flows in either direction from plug or from socket side when coupled.
- Spiral polyurethane coil hoses processed from straight tube have self-recoiling feature.

## Specifications

Body material	Socket : Engineering plastics (PBT, POM) Plug : Steel (Chrome plated)			
Size	ø5 mm x ø8 mm, ø6.5 mm x ø10 mm, ø8.5 mm x ø12.5 mm			
Working pressure	MPa	NK CUPLA HOSE : 1.0	NK CUPLA COIL HOSE : 0.7	
	kgf/cm <sup>2</sup>	NK CUPLA HOSE : 10	NK CUPLA COIL HOSE : 7	
	bar	NK CUPLA HOSE : 10	NK CUPLA COIL HOSE : 7	
	PSI	NK CUPLA HOSE : 145	NK CUPLA COIL HOSE : 102	
Seal material	Nitrile rubber	Mark	NBR (SG)	Working temperature range
Working temperature range			-5°C to +60°C	Remarks
Standard material				

## Tightening Torque Range

	Nm {kgf·cm}		
Size	ø5 mm x ø8 mm	ø6.5 mm x ø10 mm	ø8.5 mm x ø12.5 mm
Torque (Socket)	1.6 to 2.0 {16 to 20}	1.6 to 2.0 {16 to 20}	2.2 to 2.8 {22 to 29}
Torque (Plug)	5 to 6 {51 to 61}	5 to 6 {51 to 61}	7 to 8 {71 to 82}

## Flow Direction

Fluid flow can be bi-directional when socket and plug are connected.

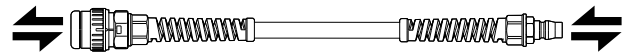

## Interchangeability

Interchangeable with HI CUPLA models 10, 17, 20, 30 and 40.  
Interchangeable with each models of NUT CUPLA series and HI CUPLA series (except models 400, 600, and 800).  
Please see [page 19](#) for "HI CUPLA Series Interchangeability".

## Suitability for Vacuum

Not suitable for vacuum application in either connected or disconnected condition.

## Models and Dimensions / Hose length

### Plug / Socket

### NK CUPLA HOSE



Model	Hose size	Hose length	Socket	Plug
			HI CUPLA ACE	NUT CUPLA
NKU-605B	ø6.5 mm x ø10 mm	5 m	HA-65SNG	65PNG
NKU-610B	ø6.5 mm x ø10 mm	10 m	HA-65SNG	65PNG
NKU-620B	ø6.5 mm x ø10 mm	20 m	HA-65SNG	65PNG
NKU-810B	ø8.5 mm x ø12.5 mm	10 m	HA-85SNG	85PNG
NKU-820B	ø8.5 mm x ø12.5 mm	20 m	HA-85SNG	85PNG

### Plug / Socket

### NK CUPLA COIL HOSE

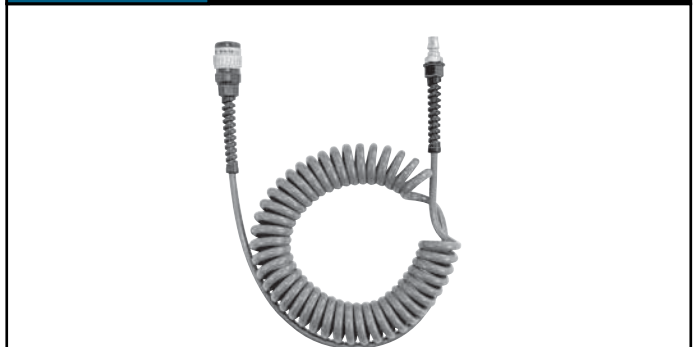

Model	Hose size	Maximum extensible length	Socket	Plug
			HI CUPLA ACE	NUT CUPLA
NKC-503B	ø5 mm x ø8 mm	2 m	HA-50SNG	50PNG
NKC-505B	ø5 mm x ø8 mm	4 m	HA-50SNG	50PNG
NKC-603B	ø6.5 mm x ø10 mm	2 m	HA-65SNG	65PNG
NKC-605B	ø6.5 mm x ø10 mm	4 m	HA-65SNG	65PNG

For Low Pressure

# MINI CUPLA

Standard type for use on equipment for welding and gas cutting, etc.

<b>Working pressure</b> 0.7 0.7 MPa (7 kgf/cm <sup>2</sup> )	<b>Valve structure</b> One-way shut-off	<b>Applicable fluids</b> Oxygen, Fuel Gas
---	--	--

## Exclusively for oxyacetylene equipment. Many variations with higher flow rates!

- From cylinders to torches, all piping connections associated with welding and cutting equipment are push-to-connect operations.
- Double-lip seal prevents minor leak during connection. Oxygen and fuel gas CUPLA have different sizes to prevent accidental interconnection.
- Pressure loss is minimized to achieve higher flow rate.
- Various types of end configurations have been standardized to comply with a wide range of welding and cutting equipment applications. Sockets themselves or plugs themselves are interchangeable with MINI CUPLA SUPER's counterparts.
- LINE CUPLA MINI is also available for multiple piping.

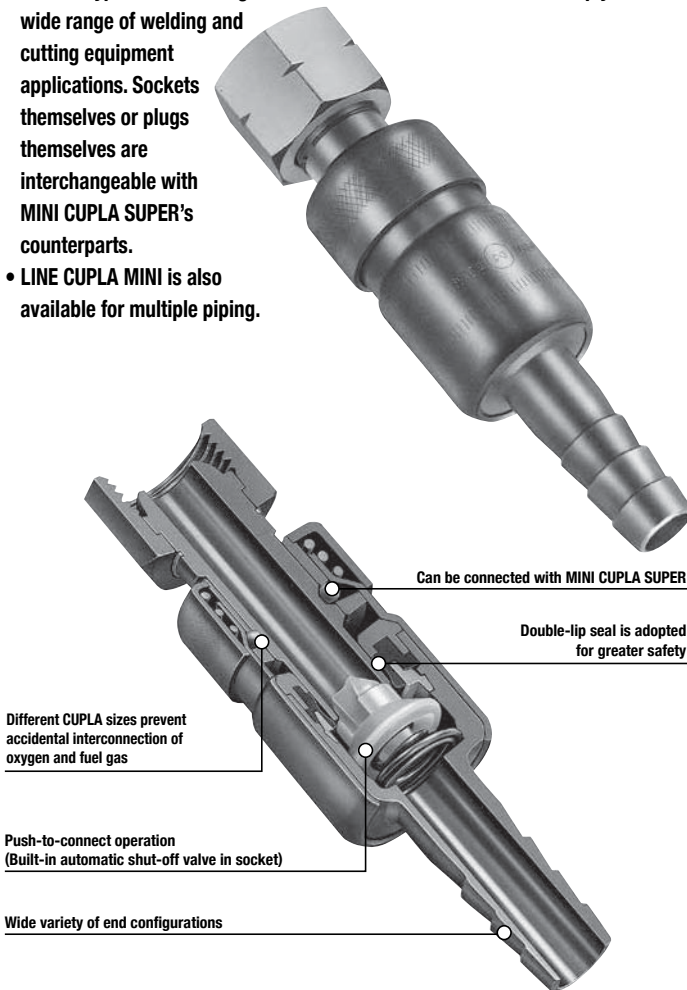

### Structure and Principle of Backflow Prevention

#### Plug with backflow stop valve

Plugs with backflow stop valve in MINI CUPLA are designed exclusively for gas welding/cutting to prevent occurrence of gas mixing. Possible backflow of gas during operation can be stopped by cutting the back flow into the cylinder or line. Such valve is adopted in both fuel gas and oxygen plug.

Cross-section sketch showing the structure

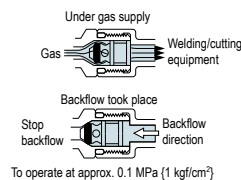
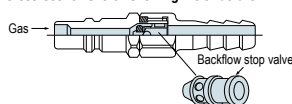

### Specifications

Body material		Brass			
Size	Thread	1/8", 1/4", 3/8" / M16, W12.5-20			
	Hose barb	1/4", 5/16", 3/8"			
Pressure unit	MPa	kgf/cm <sup>2</sup>	bar	PSI	
Working pressure	0.7	7	7	102	
Seal material	Seal material	Mark	Working temperature range	Remarks	
Working temperature range	Nitrile rubber	NBR (SG)	-20°C to +80°C	Standard material	

### Maximum Tightening Torque

Nm {kgf·cm}

Model	22PF, 22PFB, 22SF, 25PF, 33PF, 33PFB, 33SF	22SM	33SM
Torque	12 {122}	9 {92}	11 {112}

### Flow Direction

Fluid must run from socket to plug.



### Interchangeability

To prevent accidental connection, CUPLA for oxygen are not interchangeable with CUPLA for fuel gas. However, plugs and sockets for oxygen are interchangeable regardless of end configurations and plugs and sockets for fuel gas are interchangeable regardless of end configurations.

\*Interchangeable with MINI CUPLA SUPER.

### Minimum Cross-Sectional Area

(mm<sup>2</sup>)

#### For Oxygen

Socket \ Plug	22PH	25PH	22PF	22PFF	25PF	22PHB	25PHB	22PFB	21PMT	22PMT
22SH	19.6	19.6	19.6	19.6	19.6	15.9	15.9	15.9	19.6	19.6
25SH	19.6	19.6	19.6	19.6	19.6	15.9	15.9	15.9	19.6	19.6
22SF	19.6	19.6	19.6	19.6	19.6	15.9	15.9	15.9	19.6	19.6
22SM	19.6	19.6	19.6	19.6	19.6	15.9	15.9	15.9	19.6	19.6

#### For Fuel Gas

Socket \ Plug	33PH	35PH	33PF	33PHB	35PHB	33PFB
33SH	44.1	28.2	44.1	15.9	15.9	15.9
35SH	28.2	28.2	28.2	15.9	15.9	15.9
33SF	19.6	19.6	19.6	15.9	15.9	15.9
33SM	44.1	28.2	44.1	15.9	15.9	15.9

### Suitability for Vacuum

Not suitable for vacuum application in either connected or disconnected condition.

### Pressure - Flow Characteristics

[Test conditions] • Fluid : Air • Temperature : Room temperature

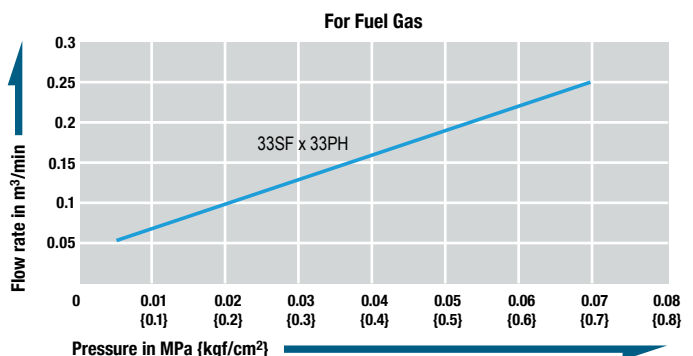
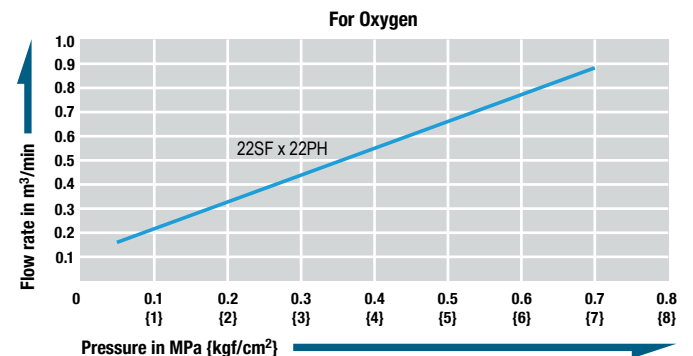

Models and Dimensions

**Plug PH type (Hose barb)**

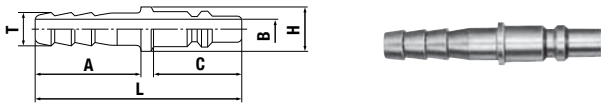

Usage	Model	Application (Hose)	Mass (g)	Dimensions (mm)					
				L	C	A	ØH	ØT	ØB
For Oxygen	22PH	1/4"	16	55	23.5	28	11	7.8	5
	25PH	5/16"	19					9	
For Fuel Gas	33PH	3/8"	22	57	25.5	28	14	10.5	7.5
	35PH	5/16"	20					9	6

**Socket SH type (Hose barb)**

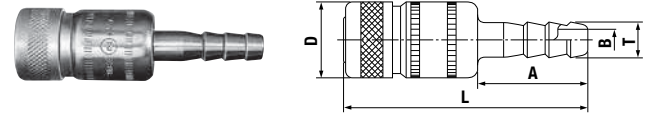

Usage	Model	Application (Hose)	Mass (g)	Dimensions (mm)				
				L	ØD	A	ØT	ØB
For Oxygen	22SH	1/4"	52	(64)	(19.8)	29	7.8	5
	25SH	5/16"	55				9	
For Fuel Gas	33SH	3/8"	69	(65)	(22.6)	29	10.5	7.5
	35SH	5/16"	67				9	6

**Plug PF type (Female thread for torch connection)**

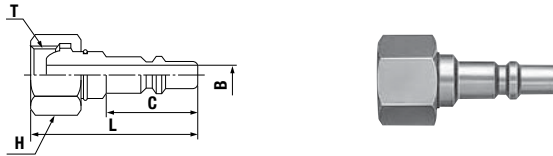

Usage	Model	Application (Thread)	Mass (g)	Dimensions (mm)				
				L	C	H(WAF)	T	ØB
For Oxygen	22PF	For oxygen torch side	31	(43)	23.5	Hex.19	M16 x 1.5	5
	22PFF		29	(43.5)			G 1/4	
	25PF		26				W12.5-20	
For Fuel Gas	33PF	For fuel gas torch side	36	(44.5)	25.5	Hex.19	M16 x 1.5 left-hand thread	7.5

**Socket SF type (Female thread for cylinder connection)**

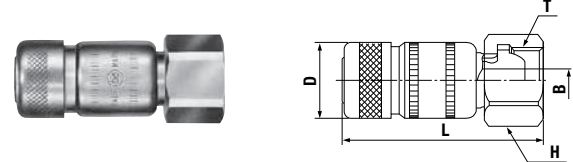

Usage	Model	Application (Thread)	Mass (g)	Dimensions (mm)				
				L	ØD	T	ØB	H(WAF)
For Oxygen	22SF	For oxygen gauge side	80	(52)	(19.8)	M16 x 1.5	5	Hex.19
For Fuel Gas	33SF	For fuel gas gauge side	96	(54)	(22.6)	M16 x 1.5 left-hand thread	5	Hex.19

**Plug PHB type (Hose barb with backflow stop valve)**

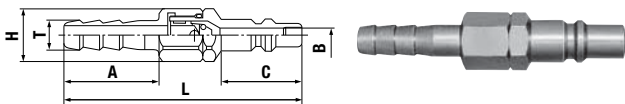

Usage	Model	Application (Hose)	Mass (g)	Dimensions (mm)					
				L	C	A	ØH	ØT	ØB
For Oxygen	22PHB	1/4"	31	(69.6)	23.5	28	15.5	7.8	4.5
	25PHB	5/16"	34					9	
For Fuel Gas	33PHB	3/8"	41	(70.6)	25.5	28	15.5	10.5	4.5
	35PHB	5/16"	39					9	

**Socket SM type (Male thread)**

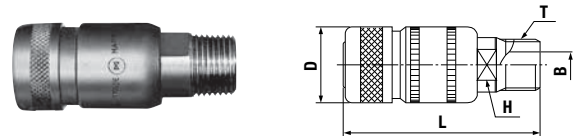

Usage	Model	Application (Thread)	Mass (g)	Dimensions (mm)				
				L	ØD	H(WAF)	T	ØB
For Oxygen	22SM	Rc 1/4	51	(52)	(19.8)	12	R 1/4	7.5
For Fuel Gas	33SM	Rc 3/8	77	(55)	(22.6)	14	R 3/8	10

**Plug PFB type (Female thread with backflow stop valve for torch connection)**

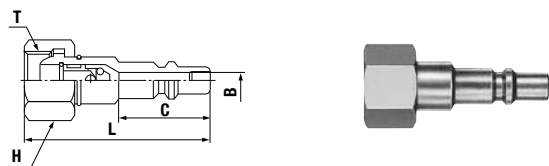

Usage	Model	Application (Thread)	Mass (g)	Dimensions (mm)				
				L	C	H(WAF)	T	ØB
For Oxygen	22PFB	For oxygen torch side	36	(48.5)	23.5	Hex.19	M16 x 1.5	4.5
For Fuel Gas	33PFB	For fuel gas torch side	41	(49)	25.5	Hex.19	M16 x 1.5 left-hand thread	4.5

**Plug PMT type (Male thread)**



Usage	Model	Application (Thread)	Mass (g)	Dimensions (mm)				
				L	C	H(WAF)	T	ØB
For Oxygen	21PMT	Rc 1/8	22	43.5	24	Hex.14	R 1/8	5
	22PMT	Rc 1/4	27	45	24	Hex.14	R 1/4	5

**Socket LINE CUPLA MINI LM-32 (For three port branch piping)**

Mass : 4,300 g  
 • Dust caps come with the product as standard.

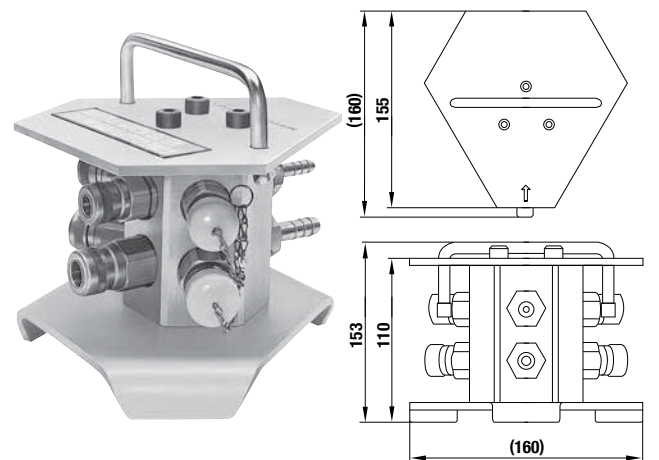

LINE CUPLA MINI contains:	Dimensions (mm)		
	For Oxygen	For Fuel Gas	Qty
Supply port	1/4"	3/8"	Each 1 pc.
Gas outlets	22SM	33SM	Each 3 pc.
Accessories (Plug with backflow stop valve)	22PHB	33PHB	Each 3 pc.



For Low Pressure

# MINI CUPLA SUPER

Heavy-duty push-to-connect type for oxyacetylene piping

<b>Working pressure</b>	<b>Valve structure</b>	<b>Applicable fluids</b>
0.7 MPa (7 kgf/cm <sup>2</sup> )	One-way shut-off	Oxygen, Fuel Gas

## Exclusively for welding and cutting equipment.

- From cylinders to torches, all piping connections associated with welding and cutting equipment are push-to-connect operations.
- Plated body for better corrosion resistance.
- Heat-treated plugs for better durability.
- Oxygen and fuel gas CUPLA have different configuration sizes with sleeves in different appearances, silver colored plating for oxygen and copper colored plating for fuel gas, to prevent accidental interconnection.
- Smaller diameter design enables wider range of applications.
- Various types of end configurations have been standardized to comply with a wide range of welding and cutting equipment applications. Sockets themselves or plugs themselves are interchangeable with MINI CUPLA's counterparts.

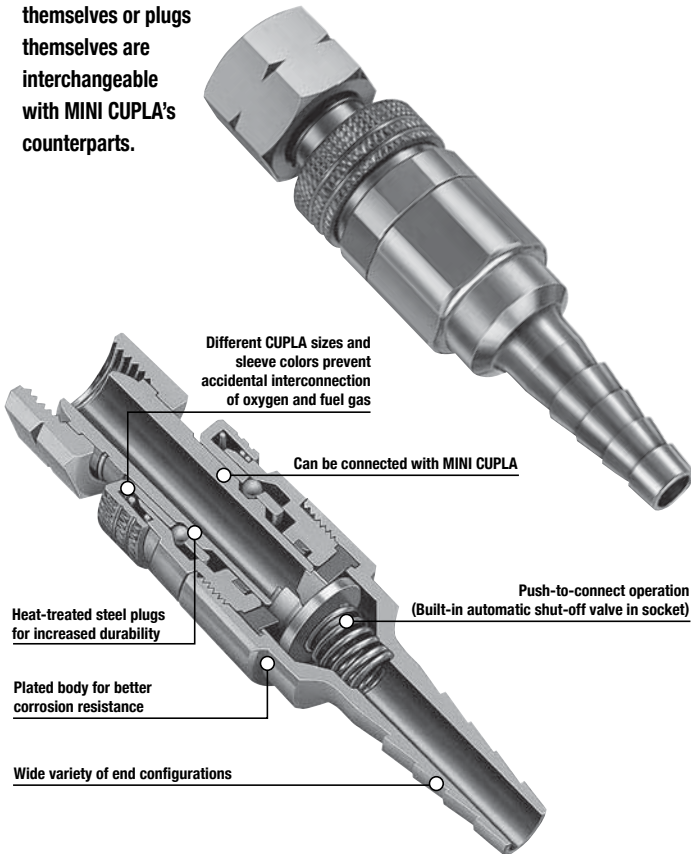

### Structure and Principle of Backflow Prevention

#### Plug with backflow stop valve

Plugs with backflow stop valve in MINI CUPLA SUPER are designed exclusively for gas welding/cutting to prevent occurrence of gas mixing. Possible backflow of gas during operation can be stopped by cutting the back flow into the cylinder or line. Such valve is adopted in both fuel gas and oxygen plug.

Cross-section sketch showing the structure

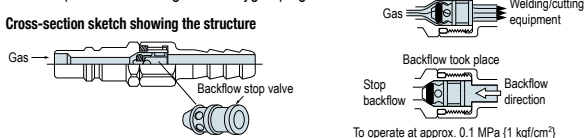

### Specifications

<b>Body material</b>	Socket : Brass (Chrome plated) Plug : Steel (Chrome plated)			
<b>Size</b>	<b>Thread</b>	1/4", 3/8", M16		
	<b>Hose barb</b>	1/4", 5/16", 3/8" / 5 mm ID		
<b>Pressure unit</b>	<b>MPa</b>	<b>kgf/cm<sup>2</sup></b>	<b>bar</b>	<b>PSI</b>
<b>Working pressure</b>	0.7	7	7	102
<b>Seal material</b>	<b>Seal material</b>	<b>Mark</b>	<b>Working temperature range</b>	<b>Remarks</b>
<b>Working temperature range</b>	Nitrile rubber	NBR (SG)	-20°C to +80°C	Standard material

### Maximum Tightening Torque

Nm {kgf·cm}

<b>Model</b>	S22PF, S22SF, S33PF, S33SF	S22SM	S33SM
<b>Torque</b>	12 {122}	9 {92}	11 {112}

### Flow Direction

Fluid must run from socket to plug.



### Interchangeability

To prevent accidental connection, CUPLA for oxygen are not interchangeable with CUPLA for fuel gas. However, plugs and sockets for oxygen are interchangeable regardless of end configurations and plugs and sockets for fuel gas are interchangeable regardless of end configurations. Can be connected with MINI CUPLA series.

### Minimum Cross-Sectional Area

(mm<sup>2</sup>)

#### For Oxygen

Socket \ Plug	S22PH	S225PH	S22PF	S22PN
S22SH	15.9	7.5	15.9	15.9
S225SH	7.5	7.5	7.5	7.5
S22SF	15.9	7.5	15.9	15.9
S22SM	15.9	7.5	15.9	15.9
S22SN	15.9	7.5	15.9	15.9

#### For Fuel Gas

Socket \ Plug	S33PH	S335PH	S33PF	S33PN
S33SH	28.2	7.5	28.2	15.9
S335SH	7.5	7.5	7.5	7.5
S33SF	28.2	7.5	28.2	15.9
S33SM	28.2	7.5	28.2	15.9
S33SN	15.9	7.5	15.9	15.9

### Suitability for Vacuum

Not suitable for vacuum application in either connected or disconnected condition.

### Pressure - Flow Characteristics

[Test conditions] • Fluid : Air • Temperature : Room temperature

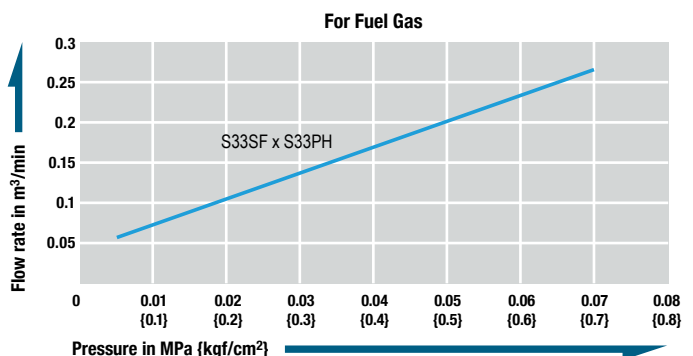
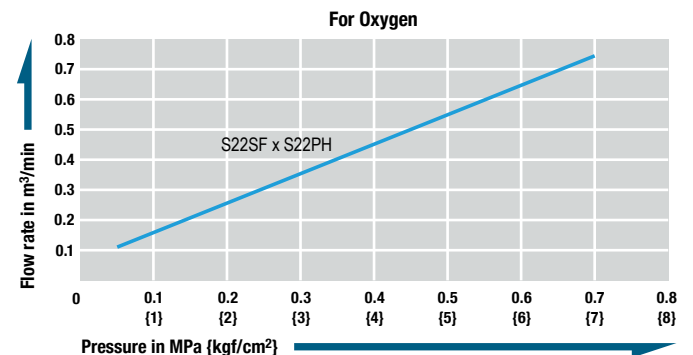

Models and Dimensions

**Plug PH type (Hose barb)**

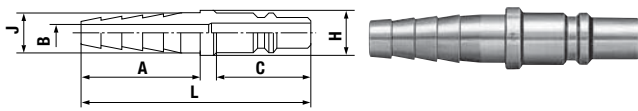

Usage	Model	Application (Hose)	Mass (g)	Dimensions (mm)					
				L	C	A	øH	øJ	øB
For Oxygen	S22PH	1/4", 5/16"	17	58	23.5	30	11	9.5	4.5
For Oxygen	S225PH	5 mm ID	12	49	23.5	21	11	6.2	3.1
For Fuel Gas	S33PH	5/16", 3/8"	22	59.5	25.5	30	14	11	6
For Fuel Gas	S335PH	5 mm ID	15	50.5	25.5	21	14	6.2	3.1
For Fuel Gas	S32PH*1	1/4", 5/16"	20	59.5	25.5	30	14	9	4.5

**Plug PF type (Female thread for torch connection)**

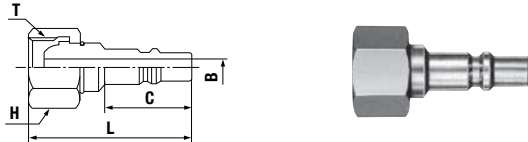

Usage	Model	Application (Thread)	Mass (g)	Dimensions (mm)				
				L	C	H(WAF)	T	øB
For Oxygen	S22PF	For oxygen torch side	35	(43)	23.5	Hex.19	M16 x 1.5	5
For Fuel Gas	S33PF	For fuel gas torch side	32	(44.5)	25.5	Hex.19	M16 x 1.5 left-hand thread	7.5

**Plug PFB type (Female thread with backflow stop valve for torch connection)**

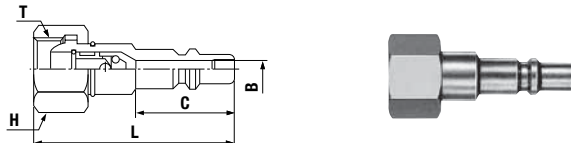

Usage	Model	Application (Thread)	Mass (g)	Dimensions (mm)				
				L	C	H(WAF)	øT	øB
For Oxygen	S23PFB-2*1	For oxygen torch side	48	(51)	23.5	Hex.21	BS 3/8	4.5
For Fuel Gas	S33PFB-2*1	For fuel gas torch side	52	(51)	25.5	Hex.21	BS 3/8 left-hand thread	4.5

**Plug PN type (Nut type for small diameter hose)**

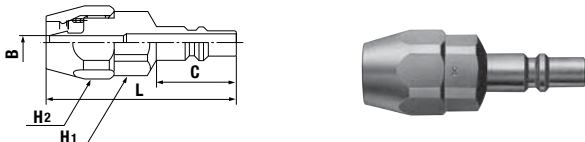

Usage	Model	Application (Hose)	Mass (g)	Dimensions (mm)				
				L	C	H1(WAF)	H2(WAF)	øB
For Oxygen	S22PN	5 mm ID <sup>2</sup>	54	(53.5)	23.5	Hex.17	Hex.19	4.5
For Fuel Gas	S33PN	5 mm ID <sup>2</sup>	57	(54.5)	25.5	Hex.17	Hex.19	4.5

Application Example



**Socket SH type (Hose barb)**

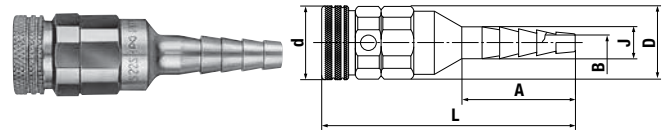

Usage	Model	Application (Hose)	Mass (g)	Dimensions (mm)					
				L	ød	øD	A	øJ	øB
For Oxygen	S22SH	1/4", 5/16"	50	(64.5)	(19.5)	20	30	9.5	4.5
For Oxygen	S225SH	5 mm ID	54	(62.5)	(19.5)	20	21	6.2	3.1
For Fuel Gas	S33SH	5/16", 3/8"	73	(68)	(22)	22	30	11	6
For Fuel Gas	S335SH	5 mm ID	65	(63)	(22)	22	21	6.2	3.1
For Fuel Gas	S32SH*1	1/4", 5/16"	74	(72.5)	(22)	22	30	9	4.5

**Socket SF type (Female thread for cylinder connection)**

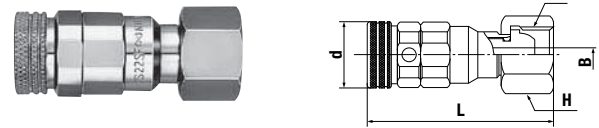

Usage	Model	Application (Thread)	Mass (g)	Dimensions (mm)				
				L	ød	T	H(WAF)	øB
For Oxygen	S22SF	For oxygen torch side	74	(52.5)	(19.5)	M16 x 1.5	Hex.19	4.5
For Fuel Gas	S33SF	For fuel gas torch side	97	(57.5)	(22)	M16 x 1.5 left-hand thread	Hex.19	6
For Oxygen	S23SF-BS*1	For oxygen torch side	82	(55.5)	(19.5)	BS 3/8	Hex.21	4.5
For Fuel Gas	S33SF-BS*1	For fuel gas torch side	88	(59)	(22)	BS 3/8 left-hand thread	Hex.21	6

**Socket SM type (Male thread)**

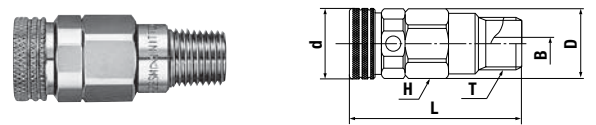

Usage	Model	Application (Thread)	Mass (g)	Dimensions (mm)					
				L	ød	øD	H(WAF)	T	øB
For Oxygen	S22SM	Rc 1/4	58	(48.5)	(19.5)	20	Hex.18	R 1/4	4.5
For Fuel Gas	S33SM	Rc 3/8	85	(52)	(22)	23	Hex.21	R 3/8	6

**Socket SN type (Nut type for small diameter hose)**

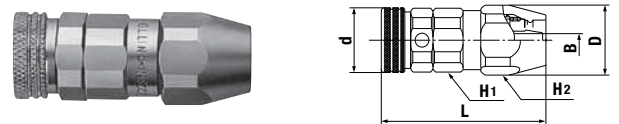

Usage	Model	Application (Hose)	Mass (g)	Dimensions (mm)					
				L	ød	øD	H1(WAF)	H2(WAF)	øB
For Oxygen	S22SN	5 mm ID <sup>2</sup>	74	(52)	(19.5)	20.5	Hex.18	Hex.19	4.5
For Fuel Gas	S33SN	5 mm ID <sup>2</sup>	91	(57)	(22)	20.5	Hex.21	Hex.19	4.5

\*1 : Made-to-order item.

\*2 : Available hose sizes are ø5 mm x ø11.2 mm, ø5 mm x ø11.5 mm and ø5 mm x ø11.8 mm.

■ Select the combination in accordance with your own application.

<p>Male thread</p>	<p>For regulator</p>	<p>For extension hose</p>	<p>For torch</p>
Suggested combination SM x PH	Suggested combination SF x PH	Suggested combination SH x PH	Suggested combination SH x PF

For Low Pressure

# MOLD CUPLA

General purpose and mold coolant port coupling

Working pressure



Valve structure



Applicable fluids



Designed for quick replacement for die and mold !  
Rust resistant models having many variations.

- Space saving design for molds with closely spaced coolant ports.
- Long sleeve socket facilitates connection/disconnection with plug embedded in mold.
- Enables quick mold cooling water line connection/disconnection.
- Various sizes and end configurations to suit a wide variety of mold applications.
- Can be connected with SUPER CUPLA, excluding K3 and K4 types.
- Push-to-connect design. (Built-in automatic shut-off valve in the socket)  
Also available is CUPLA without valve (Please specify in ordering).
- CUPLA for braided hose connection requires no hose clamp. (Model K-90SN)

For Braided Hose

Please use braided hoses available in the market.



Benefits without a hose clamp

Two piece design

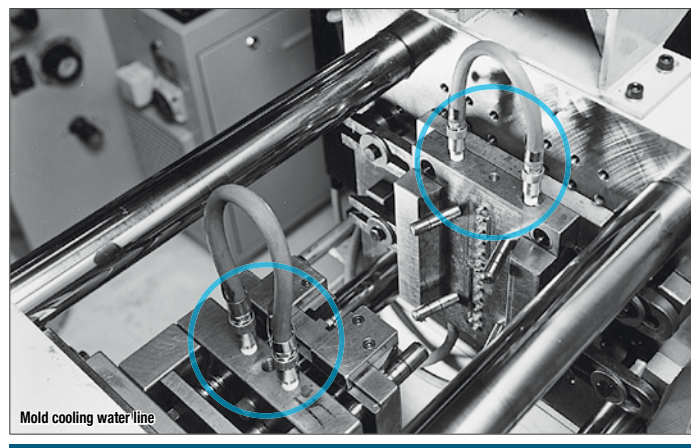

Mold cooling water line

## Specifications

Body material	Brass			
Size	Thread	1/8", 1/4", 3/8"		
	Hose barb	Hose: 1/4", 3/8" / Braided hose: ø9 mm x ø15 mm		
Pressure unit	MPa	kgf/cm <sup>2</sup>	bar	PSI
Working pressure	1.0	10	10	145
Seal material Working temperature range	Seal material	Mark	Working temperature range	Remarks
	Nitrile rubber	NBR (SG)	-20°C to +80°C	Standard material
	Fluoro rubber	FKM (X-100)	-20°C to +180°C	Available on request

Maximum working pressure and working temperature range of CUPLA for braided hoses depend upon the specifications of braided hoses to be used.

## Maximum Tightening Torque

Nm {kgf·cm}

Size (Thread)	1/8"	1/4"	3/8"
Torque	5 {51}	9 {92}	11 {112}

Tighten the nut until it is flush against the hose barb base after pushing a braided hose to the end.

## Flow Direction

Fluid flow can be bi-directional when socket and plug are connected.



## Interchangeability

Sockets and plugs can be connected regardless of end configurations and sizes. K-0 series are not interchangeable with high flow type K3 and K4 series. Can be connected with SUPER CUPLA.

## Minimum Cross-Sectional Area

(mm<sup>2</sup>)

Socket Plug	Plug													
	K-02SH	K-02TSH	K-03SH	K-03TSH	K-02SM	K-02TSM	K-03SM	K-03TSM	K-02SF	K-02TSF	K-02SHL	K-03SHL	K-03TSHL	K-90SN
K-02PH	15.5	15.5	15.5	15.5	15.5	15.5	15.5	15.5	15.5	15.5	15.5	15.5	15.5	15.5
K-03PH	19	19	28	28	28	28	28	28	28	28	15.5	28	28	28
K-01PM	19	19	23	23	23	23	23	23	23	23	15.5	23	23	23
K-01PM-HH	19	19	23	23	23	23	23	23	23	23	15.5	23	23	23
K-02PM	19	19	28	28	28	28	28	28	28	28	15.5	28	28	28
K-02PM-HH	19	19	23	23	23	23	23	23	23	23	15.5	23	23	23
K-03PM	19	19	28	28	28	28	28	28	28	28	15.5	28	28	28
K-01PF	19	19	28	28	28	28	28	28	28	28	15.5	28	28	28
K-02PF	19	19	28	28	28	28	28	28	28	28	15.5	28	28	28
K-03PF	19	19	28	28	28	28	28	28	28	28	15.5	28	28	28
K-01PML	19	19	19	19	19	19	19	19	19	19	15.5	19	19	19
K-02PML	19	19	28	28	28	28	28	28	28	28	15.5	28	28	28
K-03PML	19	19	28	28	28	28	28	28	28	28	15.5	28	28	28

## Suitability for Vacuum

Not suitable for vacuum application in either connected or disconnected condition.

## Plug Embedment Dimensions

(mm)

Model	D*	C*	L	Remarks
K-01PM-HH	20 or more	0 to 3	24	
K-02PM	20 or more	0 to 3	29	* Size D should be bigger than the outer diameter of the socket wrench to be used.
K-02PM-HH	20 or more	0 to 3	24	(See JISB4636-1, JISB4636-2)
K-03PM	20 or more	0 to 3	30	

## Flow Rate – Pressure Loss Characteristics

[Test conditions] • Fluid : Water • Temperature : 25°C±5°C

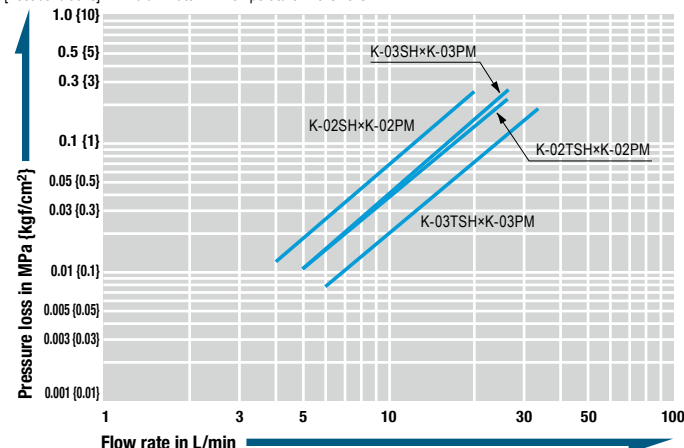



Models and Dimensions

**Plug PH type (Hose barb)**

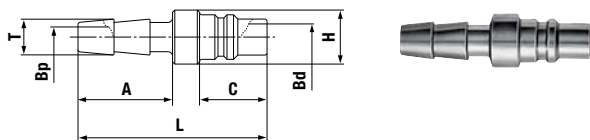

Model	Application (Hose)	Mass (g)	Dimensions (mm)						
			L	A	C	øH	øT	øBp	øBd
K-02PH	1/4"	17	42	21	15	12	8	4.5	6
K-03PH	3/8"	19	42	21	15	15	12	7	6

**Plug PM type (Male thread)**

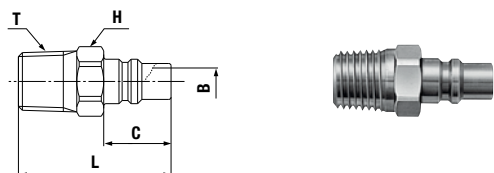

Model	Application (Thread)	Mass (g)	Dimensions (mm)					
			L	H(WAF)	C	T	øB	
K-01PM	Rc 1/8	14	31	Hex.12	15	R 1/8	5.5	
K-02PM	Rc 1/4	20	34	Hex.14	15	R 1/4	6	
K-03PM	Rc 3/8	35	35	Hex.17	15	R 3/8	6	

**Plug PF type (Female thread)**

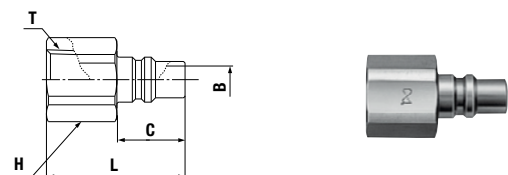

Model	Application (Thread)	Mass (g)	Dimensions (mm)				
			L	H(WAF)	C	T	øB
K-01PF	R 1/8	16	28	Hex.14	15	Rc 1/8	6
K-02PF	R 1/4	22	30.5	Hex.17	15	Rc 1/4	6
K-03PF	R 3/8	35	32	Hex.21	15	Rc 3/8	6

**Plug PML type (Male thread)**

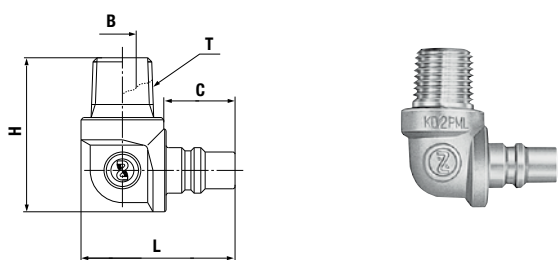

Model	Application (Thread)	Mass (g)	Dimensions (mm)				
			L	C	H	T	øB
K-01PML	Rc 1/8	43	33.5	15	30.5	R 1/8	5
K-02PML	Rc 1/4	53	33.5	15	33.5	R 1/4	6
K-03PML	Rc 3/8	71	33.5	15	33.5	R 3/8	6

**Plug PM-HH type (Male thread)**

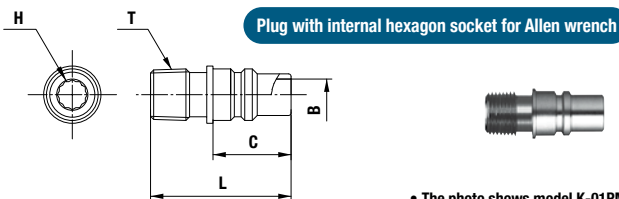

• The photo shows model K-01PM-HH.

Model	Application (Thread)	Mass (g)	Dimensions (mm)					
			Outside Diameter	L	H	C	T	øB
K-01PM-HH	Rc 1/8	9	ø11	27	5	15	R 1/8	6
K-02PM-HH	Rc 1/4	15	ø(13.4)	29	5	15	R 1/4	6

**Socket SH type (Hose barb)**

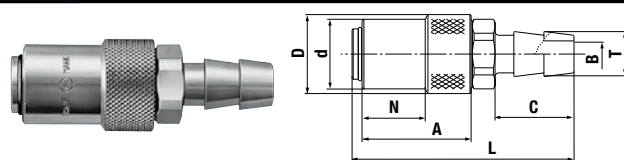

Model	Application (Hose)	Mass (g)	Dimensions (mm)							
			L	øD	ød	N	A	C	øT	øB
K-02SH	1/4	52	(67)	(21)	18.5	16.8	29	29	8	5
K-02TSH-1	1/4	52	(67)	(21)	18.5	16.8	29	29	8	5
K-03SH	3/8	60	(59)	(21)	18.5	16.8	29	21	12	7
K-03TSH-1	3/8	60	(59)	(21)	18.5	16.8	29	21	12	7

**Socket SM type (Male thread)**

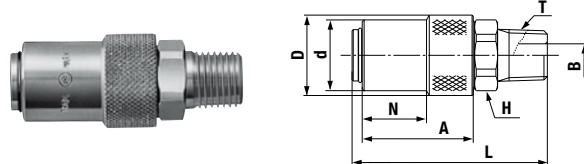

Model	Application (Thread)	Mass (g)	Dimensions (mm)							
			L	øD	ød	N	A	H(WAF)	T	øB
K-02SM	Rc 1/4	70	(51)	(21)	18.5	16.8	29	Hex.17	R 1/4	6
K-02TSM-1	Rc 1/4	70	(51)	(21)	18.5	16.8	29	Hex.17	R 1/4	6
K-03SM	Rc 3/8	82	(52)	(21)	18.5	16.8	29	Hex.19	R 3/8	6
K-03TSM-1	Rc 3/8	82	(52)	(21)	18.5	16.8	29	Hex.19	R 3/8	6

**Socket SF type (Female thread)**

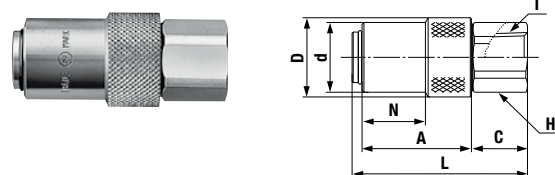

Model	Application (Thread)	Mass (g)	Dimensions (mm)							
			L	øD	ød	N	A	C	T	H(WAF)
K-02SF	R 1/4	57	(46.5)	(21)	18.5	16.8	29	14.5	Rc 1/4	Hex.17
K-02TSF-1	R 1/4	57	(46.5)	(21)	18.5	16.8	29	14.5	Rc 1/4	Hex.17

**Socket SHL type (Hose barb)**

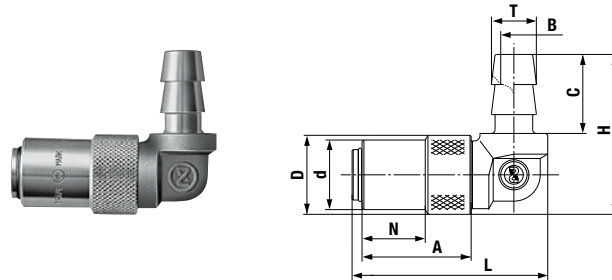

Model	Application (Hose)	Mass (g)	Dimensions (mm)								
			L	øD	ød	N	A	C	øT	H	øB
K-02SHL	1/4	79	(52)	(21)	18.5	16.8	29	21	8	(42.5)	4.5
K-03SHL	3/8	87	(52)	(21)	18.5	16.8	29	21	12	(42.5)	7
K-03TSHL-1	3/8	87	(52)	(21)	18.5	16.8	29	21	12	(42.5)	7

\*1: Also available without socket valve (Made-to-order item), identified by product code TS (e.g. K-03SH without valve is K-03TSH). Also available are sockets with sleeve stopper (Made-to-order item).

**Socket SN type (For braided hose connection)**

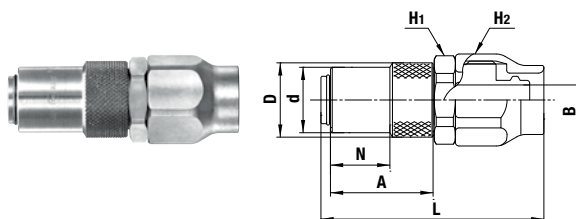

Model	Application (Hose) (mm)	Hose wall thickness (mm)	Mass (g)	Dimensions (mm)							
				L	øD	ød	N	A	H1(WAF)	H2(WAF)	øB
K-90SN	ø9 x ø15	3±0.3	122	(63)	(21)	18.5	16.8	29	Hex.23	Hex.24	8.5

Before use, please be sure to read "Safety Guide" described at the end of this book and "Instruction Sheet" that comes with the products.



For Low Pressure

# MOLD CUPLA

High Flow Type

High flow type mold coolant port coupling

Working pressure



Valve structure



Applicable fluids



## Flow rate has doubled to increase productivity.

- High flow type K3 and K4 series are added to MOLD CUPLA series for mold coolant and heated oil port coupling.
- Almost double flow rate compared with our standard K-01, K-02 and K-03 series, increasing productivity.
- Space saving design for molds with closely spaced coolant ports.
- Long sleeve socket facilitates connection / disconnection with plug embedded in mold.
- Enables quick mold coolant hose connection / disconnection.



### Results of reduced cooling time in the field

A customer replaced conventional K-0 series MOLD CUPLA with the K3 series and shortened the cooling time from 30 seconds to 21 seconds meaning an 18% reduction per shot and increased productivity by 20%. Temperature checks at 8 positions on the mold showed that surface temperatures on average had fallen by 3°C, providing evidence of the high cooling efficiency.

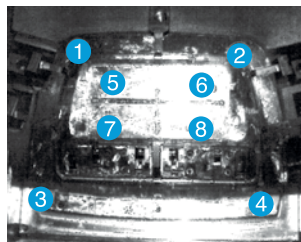

### Flow comparison

Coolant water flow rate was checked with a flow meter, which confirmed increase by 1.7 to 1.8 times, when MOLD CUPLA K3 series are used.

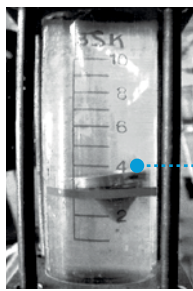

Conventional K-0 series MOLD CUPLA were used.

Increased by  
1.7 to 1.8 times UP

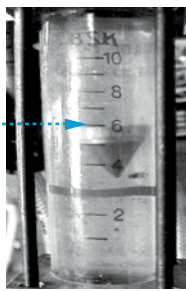

K3 series are used.

### Specifications

Body material		Brass			
Size	Thread	1/4", 3/8", 1/2"			
	Hose barb	3/8", 1/2" hose			
Pressure unit	MPa	kgf/cm <sup>2</sup>	bar	PSI	
Working pressure	1.0	10	10	145	
Seal material Working temperature range	Seal material	Mark	Working temperature range	Remarks	
	Nitrile rubber	NBR (SG)	-20°C to +80°C	Standard material	
	Fluoro rubber	FKM (X-100)	-20°C to +180°C	Available on request	

### Maximum Tightening Torque

Nm {kgf·cm}

Size (Thread)	1/4"	3/8"	1/2"
Torque	9 {92}	11 {112}	20 {204}

### Flow Direction

Fluid flow can be bi-directional when socket and plug are connected.

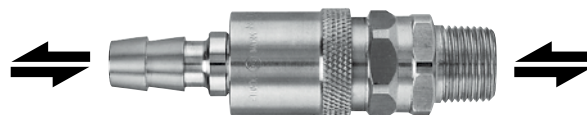

### Interchangeability

K3 series sockets and plugs can be connected regardless of end configuration and sizes. K4 series sockets and plugs can be connected regardless of end configuration and sizes. K3 series and K4 series are not interchangeable with each other. Also not interchangeable with other K-0 series.

### Minimum Cross-Sectional Area

(mm<sup>2</sup>)

Plug	Socket	K3-03SH	K3-04SH	K3-03SM	K3-03SF	K4-04SH
K3-03PH		38	38	38	38	-
K3-02PM		38	62.5	62.5	62.5	-
K3-03PM		38	62.5	62.5	62.5	-
K3-03PF		38	62.5	62.5	62.5	-
K4-04PM		-	-	-	-	78.5

### Suitability for Vacuum

Not suitable for vacuum application in either connected or disconnected condition.

### Plug Embedment Dimensions

(mm)

Model	D*	C*	L	Remarks
K3-02PM	24 or more	0 to 3	31	* Socket interference prevents connection/disconnection when C exceeds 3 mm.
K3-03PM	24 or more	0 to 3	31	* Size D should be bigger than the outer diameter of the socket wrench to be used. (See JISB4636-1, JISB4636-2)
K4-04PM	32 or more	0 to 3	39	

### Flow Rate – Pressure Loss Characteristics (Comparison with MOLD CUPLA)

[Test conditions] • Fluid : Water • Temperature : 25°C±5°C

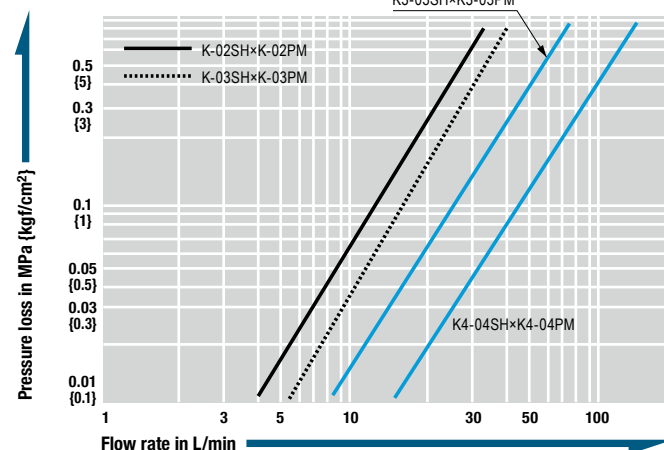

Models and Dimensions

**Plug PH type (Hose barb / High flow type)**

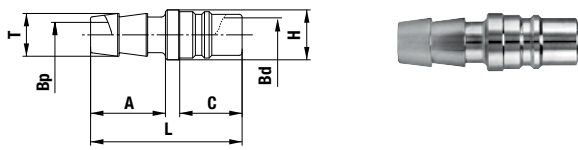

Model	Application (Hose)	Mass (g)	Dimensions (mm)						
			L	A	C	ØH	ØT	ØBp	ØBd
K3-03PH	3/8"	19	42.5	21	17.5	14	12	7	9.5

**Socket SH type (Hose barb / High flow type)**

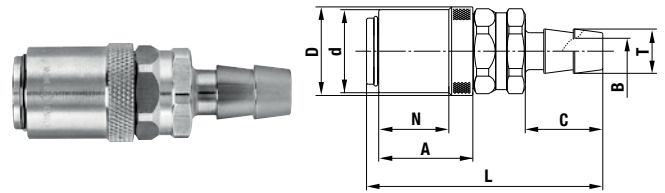

Model	Application (Hose)	Mass (g)	Dimensions (mm)							
			L	ØD	Ød	N	A	C	ØT	ØB
K3-03SH	3/8"	100	(65)	(24)	22.5	19	25.5	21	12	7
K3-04SH	1/2"	102	(67)	(24)	22.5	19	25.5	23	15	10
K4-04SH	1/2"	226	(82)	(32)	30	26.5	34	23	15	10

**Plug PM type (Male thread / High flow type)**

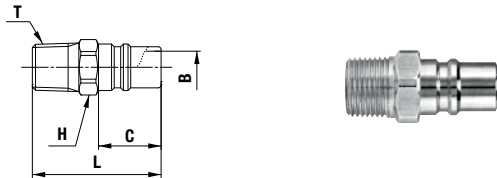

Model	Application (Thread)	Mass (g)	Dimensions (mm)				
			L	C	H(WAF)	ØT	ØB
K3-02PM	Rc 1/4	16	36	17.5	Hex.14	R 1/4	9
K3-03PM	Rc 3/8	25	36	17.5	Hex.17	R 3/8	9.5
K4-04PM	Rc 1/2	50	46	21.5	Hex.22	R 1/2	13

**Socket SM type (Male thread / High flow type)**

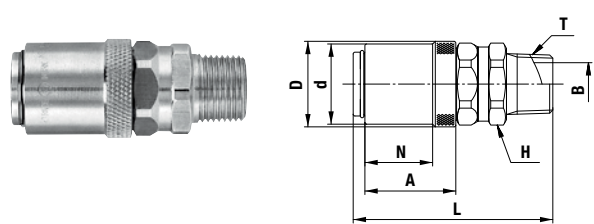

Model	Application (Thread)	Mass (g)	Dimensions (mm)							
			L	ØD	Ød	N	A	H(WAF)	T	ØB
K3-03SM	Rc 3/8	90	(56)	(24)	22.5	19	25.5	Hex.21	R 3/8	12

**Plug PF type (Female thread / High flow type)**

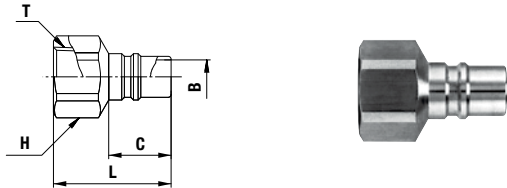

Model	Application (Thread)	Mass (g)	Dimensions (mm)				
			L	H(WAF)	C	T	ØB
K3-03PF	R 3/8	30	33	Hex.21	17.5	Rc 3/8	9.5

**Socket SF type (Female thread / High flow type)**

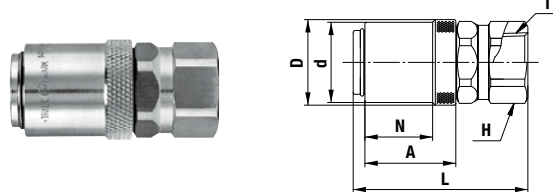

Model	Application (Thread)	Mass (g)	Dimensions (mm)							
			L	ØD	Ød	N	A	T	H(WAF)	
K3-03SF	R 3/8	87	(49)	(24)	22.5	19	25.5	Rc 3/8	Hex.21	

Notes: Also available without socket valve (Made-to-order item), identified by product code TS (e.g. K3-03SH without valve is K3-03TSH). Also available are CUPLA with sleeve stopper (Made-to-order item).

For Low Pressure

**FLOW METER**

Flow meter with special valve for mold cooling line

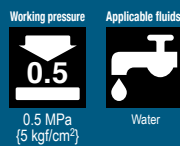

For stable and accurate coolant flow rate.

- Graduated scale enables easy visual check of coolant flow rate regardless of operator.
- Built-in flow rate adjustment valve enables desired setting of mold conditions for each machine.
- Easy resumption of previously set molding conditions to cut lead times.
- T2 side is equipped with rotary function. Even after fixing the body on T1 side to the piping, additional screw tightening on T2 side is possible.

**Pressure - Flow Characteristics**

[Test conditions] • Fluid : Water • Temperature : Room temperature  
• Valve open level : 100%

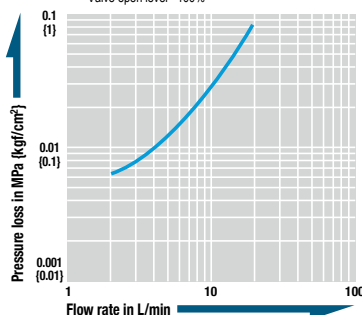

**Application**



**Specifications**

Body material	Body: Brass Graduated tube: Polycarbonate			
Size (Thread)	Both ends Rc 3/8 female thread			
Pressure unit	MPa	kgf/cm <sup>2</sup>	bar	PSI
Working pressure	0.5	5	5	72.5
Maximum flow rate	18 L/min (5 to 18 L/min adjustable)			
Seal material	Seal material	Mark	Working temperature range	Remarks
Working temperature range	Nitrile rubber	NBR (SG)	-20°C to +60°C	Standard material

• Use within the temperature range of +10°C to +60°C due to plastic float material.

**Maximum Tightening Torque**

**Nm [kgf·cm]**

Torque	11 [112]
--------	----------

**Models and Dimensions / Flow Direction**

WAF : WAF stands for width across flats.

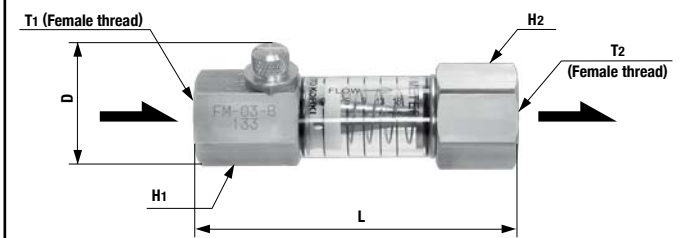

Fluid must flow in the direction of the arrows.

Model	Mass (g)	Dimensions (mm)					
		L	D	H1(WAF)	H2(WAF)	T1	T2
FM-03-B	190	(89)	(33)	Hex.23	Hex.26	Rc 3/8	Rc 3/8

Before use, please be sure to read "Safety Guide" described at the end of this book and "Instruction Sheet" that comes with the products.

For Low Pressure

# LEVER LOCK CUPLA

## Metal Body / Plastic Body

For bulk flow, low pressure applications

**Working pressure**

0.7 to 1.8 MPa  
(7 to 18 kgf/cm<sup>2</sup>)

**Working pressure**

0.2 to 0.5 MPa  
(2 to 5 kgf/cm<sup>2</sup>)

**Valve structure**

Straight through

Designs and specifications are subject to change for improvement without notice

**Applicable fluids (plastic body CUPLA are for water or air only)**

Water

Hydraulic oil

Air

Powder

Steam

Note: Depending on the temperature of steam / hot water, the heat may damage seal materials.

### Light lever pull-down will connect the plug and socket without fail ready to flow liquid or gases.

- This CUPLA complies with diversified applications in liquid or gas transportation.
- End-face seal structure enables no bumps or hollows on the internal fluid passage, and ensures smooth fluid transportation.
- A special lip packing (except sizes 3/4" and 1", silicone rubber, and FEP-covered rubber) employed reduces the load to the lever for easy operation.
- Connection part dimensions comply with US military specifications MIL-A-A-59326.
- The variety of body materials, sizes and end configurations has been standardized to comply with wide range of applications.
- Additional stopper function design will enhance safety (only for made-to-order metal body product).

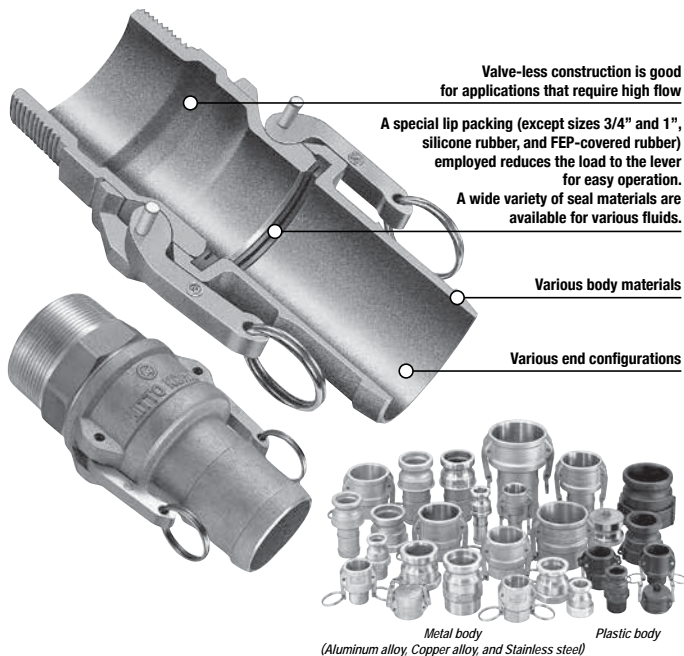

Specifications (Metal Body)								
Body material (Material symbol)	Aluminum alloy (AL), Copper alloy (BR)				Stainless steel (SUS)			
<b>Size (Thread and hose)</b>	3/4" to 2"	2 1/2"	3"	4"	3/4" to 2"	2 1/2" to 3"	4"	
<b>Working pressure</b>	MPa	1.8	1.1	0.9	0.7	1.8	1.6	1.1
	kgf/cm <sup>2</sup>	18	11	9	7	18	16	11
	bar	18	11	9	7	18	16	11
	PSI	261	160	131	102	261	232	160
<b>Seal material</b>	Nitrile rubber		Mark		NBR (SG)		Working temperature range	
<b>Working temperature range</b>	-20°C to +80°C							
<b>Optional seal material</b>	Seal material		Mark		Working temperature range			
	Silicone rubber		SI		-40°C to +150°C			
	Fluoro rubber		FKM (X-100)		-20°C to +180°C			
	Ethylene-propylene rubber		EPDM (EPT)		-40°C to +150°C			
	FEP-covered silicon rubber*		—		+5°C to +50°C			
FEP-covered fluoro rubber*		—		+5°C to +50°C				

\*Made-to-order item (Working pressure : 0.2 MPa (2 kgf/cm<sup>2</sup>))

Specifications (Plastic Body)			
Body material (Material symbol)	Polypropylene (PP)		
<b>Size (Thread and hose)</b>	3/4", 1", 1 1/2"		2", 3"
<b>Working pressure*</b>	MPa	0.5	0.2
	kgf/cm <sup>2</sup>	5	2
	bar	5	2
	PSI	72.5	29
<b>Seal material</b>	Nitrile rubber		Working temperature range
<b>Working temperature range</b>	+5°C to +50°C		
<b>Optional seal material</b>	Seal material		Working temperature range
	Silicone rubber		+5°C to +50°C
	Fluoro rubber		+5°C to +50°C
	Ethylene-propylene rubber		+5°C to +50°C

\*Pressure at 20°C. Pressure reduces as temperature rises.

Maximum Tightening Torque					Nm {kgf·cm}				
Size (Thread)	3/4"	1"	1 1/4"	1 1/2"	2"	2 1/2"	3"	4"	
<b>Torque</b>	Aluminum alloy	50 {510}	70 {714}	120 {1224}	140 {1428}	260 {2652}	350 {3570}	410 {4182}	470 {4794}
	Copper alloy								
	Stainless steel	90 {918}	120 {1224}	220 {2244}	260 {2652}	350 {3570}	480 {4896}	520 {5304}	590 {6018}

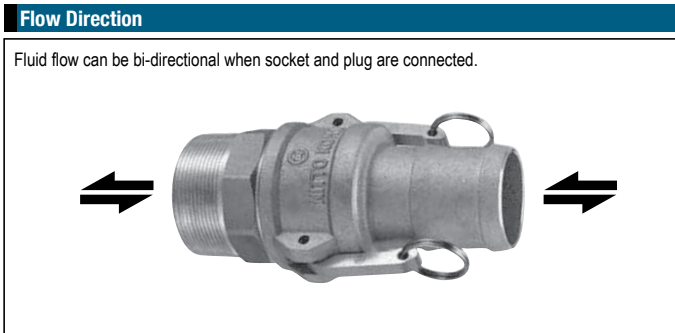

**Interchangeability**  
Sockets and plugs can be connected regardless of end configurations if the size is same. Can be connected with products whose mating part dimensions are in compliance with MIL-A-A-59326.

Suitability for Vacuum (Metal Body)		53.0 kPa {400 mmHg}	
Socket only	Plug only	When connected	
—	—	Operational	

**Suitability for Vacuum (Plastic Body)**  
Not suitable for vacuum application in either connected or disconnected condition.

### Dimensions with Lever Fully Opened

Metal	Size	Dimensions E (mm)		
		Body material		
		AL	BR	SUS
	3/4"	(122.5)	(122.5)	(111)
	1"	(132)	(132)	(125)
	1 1/4"	(183)	(183)	(179)
	1 1/2"	(191)	(191)	(187)
	2"	(201)	(201)	(196)
	2 1/2"	(213)	(209)	(209)
	3"	(249)	(249)	(251)
	4"	(280)	(278)	(277)

Plastic	Size	Dimensions E (mm)
	3/4"	(115)
	1"	(126)
	1 1/2"	(187)
	2"	(195)
	3"	(249)



Models and Dimensions

Dimensions of products may differ according to body material. / WAF : WAF stands for width across flats.

Plug LE type (Hose barb)

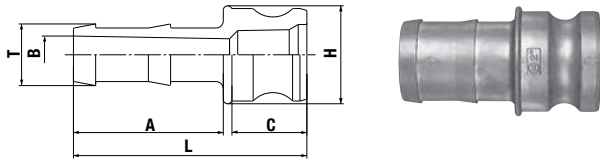

Material	Model	Application (Hose)	Mass (g)	Dimensions (mm)					
				L	A	C	øH	øT	øB
Aluminum alloy	LE-6TPH	3/4"	65	81	52	26	34	21.4	11
	LE-8TPH	1"	100	95	58	34	40	27.4	17.5
	LE-10TPH	1 1/4"	140	102	58	40	48	34.1	23.5
	LE-12TPH	1 1/2"	190	107	61	42	58	40.5	29
	LE-16TPH	2"	290	122	70	48	69	53.2	40
	LE-20TPH	2 1/2"	390	134.5	80	50	81	66.7	50
	LE-24TPH	3"	545	167	101	49.4	97	79	68
	LE-32TPH	4"	850	176	106	51.8	133	105	93
	LE-6TPH	3/4"	215	90.5	52.5	26	39	21.5	12.5
Copper alloy	LE-8TPH	1"	305	107	60	34.5	41	27.5	20
	LE-10TPH	1 1/4"	440	102	58	40	48	34.1	25.5
	LE-12TPH	1 1/2"	560	107	61	42	58	40.5	31.5
	LE-16TPH	2"	865	131	73	44	70.5	53.5	44.5
	LE-20TPH	2 1/2"	1180	149	84	48	91	67	57
	LE-24TPH	3"	1800	171	104	50	102	79	70
	LE-32TPH	4"	3500	176	109	52	129	105	93
	LE-6TPH	3/4"	170	90	52	27	35	21	15
	LE-8TPH	1"	265	107	60	35	42	27	20
Stainless steel	LE-10TPH	1 1/4"	430	111	61	40	48	34	25.5
	LE-12TPH	1 1/2"	530	114	61	40	60	40	33
	LE-16TPH	2"	790	131	73	45	70	53	44
	LE-20TPH	2 1/2"	1195	137	80.5	42.7	83	67	56
	LE-24TPH	3"	1755	162	99.5	49.2	102	78	68
	LE-32TPH	4"	2595	174	109	50	130	105	94

Socket LC type (Hose barb)

Model LC-6TSH made of aluminum alloy and copper alloy has no rings.

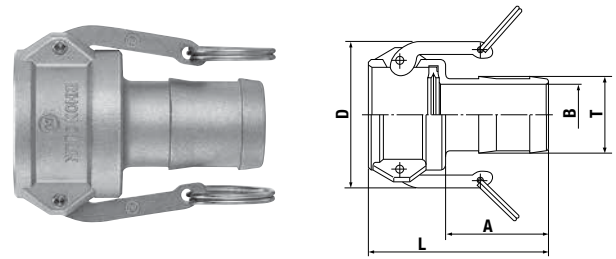

Material	Model	Application (Hose)	Mass (g)	Dimensions (mm)				
				L	A	D	øT	øB
Aluminum alloy	LC-6TSH	3/4"	140	85	52	(60.5)	21.4	(11)
	LC-8TSH	1"	190	99	58	(61)	27.4	(17)
	LC-10TSH	1 1/4"	320	104	58	(82)	34.1	(23)
	LC-12TSH	1 1/2"	350	108.5	61	(90)	40.5	(29)
	LC-16TSH	2"	430	122.5	70	(100)	53.2	(41.5)
	LC-20TSH	2 1/2"	560	136.5	80	(112)	66.7	(54)
	LC-24TSH	3"	915	175	100	(139)	79	68
	LC-32TSH	4"	1190	180	104	(165)	104	93
	LC-6TSH	3/4"	320	85	52	(60.5)	21.4	13
Copper alloy	LC-8TSH	1"	420	99	58	(61)	27.4	19.5
	LC-10TSH	1 1/4"	700	104	58	(82)	34.1	25.5
	LC-12TSH	1 1/2"	720	110	62	(91)	41	33
	LC-16TSH	2"	870	121	70	(100)	53	44
	LC-20TSH	2 1/2"	1530	137	83	(113)	67	57
	LC-24TSH	3"	1795	160	105	(139)	79	68
	LC-32TSH	4"	3100	163	107	(168)	104	92
	LC-6TSH	3/4"	230	86	52	(55)	21	15
	LC-8TSH	1"	340	99	60	(63)	27	20
Stainless steel	LC-10TSH	1 1/4"	615	107	61	(85)	34	25.5
	LC-12TSH	1 1/2"	645	108	61	(91)	40	33
	LC-16TSH	2"	1000	129	73	(101)	53	44
	LC-20TSH	2 1/2"	1270	134	81	(113)	67	57
	LC-24TSH	3"	2065	158	100	(139)	79	67
	LC-32TSH	4"	3020	165	107	(167)	105	94

Plug LA type (Female thread)

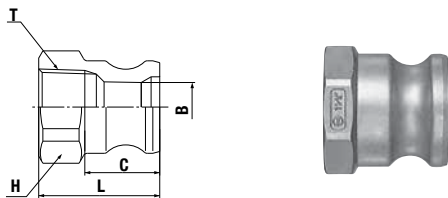

Material	Model	Application (Thread)	Mass (g)	Dimensions (mm)				
				L	C	H(WAF)	øB	T
Aluminum alloy	LA-6TPF	3/4"	45	42	26	Hex.36	17	Rc 3/4
	LA-8TPF	1"	65	52	34	Hex.41	22.5	Rc 1
	LA-10TPF	1 1/4"	110	59	40	Hex.50	27.5	Rc 1 1/4
	LA-12TPF	1 1/2"	130	58	42	Hex.60	34.5	Rc 1 1/2
	LA-16TPF	2"	170	63.5	48	Oct.70	44.5	Rc 2
	LA-20TPF	2 1/2"	320	85	50	Oct.85	55.5	Rc 2 1/2
	LA-24TPF	3"	370	79	52.5	Dod.99	73.5	Rc 3
	LA-32TPF	4"	640	82	54	Dod.130	100	Rc 4
	LA-6TPF	3/4"	145	42	27	Oct.34	20	Rc 3/4
Copper alloy	LA-8TPF	1"	190	46	32	Oct.41	24	Rc 1
	LA-10TPF	1 1/4"	390	59	40	Hex.50	28	Rc 1 1/4
	LA-12TPF	1 1/2"	420	58	42	Oct.60	36	Rc 1 1/2
	LA-16TPF	2"	560	63.5	48	Oct.70	45	Rc 2
	LA-20TPF	2 1/2"	950	79	50	Dod.84	56	Rc 2 1/2
	LA-24TPF	3"	1210	71	50	Dod.101	70	Rc 3
	LA-32TPF	4"	1620	79	53	Dod.127	101	Rc 4
	LA-6TPF	3/4"	120	39	27	Oct.33	19	Rc 3/4
	LA-8TPF	1"	170	47	33	Oct.41	24	Rc 1
Stainless steel	LA-10TPF	1 1/4"	270	53.5	41	Oct.50	28	Rc 1 1/4
	LA-12TPF	1 1/2"	375	55	40	Oct.58	35.5	Rc 1 1/2
	LA-16TPF	2"	505	62	47	Oct.69	45	Rc 2
	LA-20TPF	2 1/2"	825	77	49	Dod.83	56	Rc 2 1/2
	LA-24TPF	3"	875	72	51	Dod.96	73	Rc 3
	LA-32TPF	4"	1470	79	53	Dod.124	100	Rc 4

Socket LD type (Female thread)

Model LD-6TSF made of aluminum alloy and copper alloy has no rings.

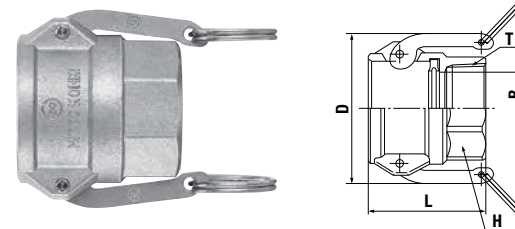

Material	Model	Application (Thread)	Mass (g)	Dimensions (mm)				
				L	D	H(WAF)	øB	T
Aluminum alloy	LD-6TSF	3/4"	130	53	(62.4)	Hex.36	21	Rc 3/4
	LD-8TSF	1"	190	64.5	(61)	Hex.41	26	Rc 1
	LD-10TSF	1 1/4"	330	72.5	(82)	Hex.50	34	Rc 1 1/4
	LD-12TSF	1 1/2"	360	70.5	(90)	Oct.60	39	Rc 1 1/2
	LD-16TSF	2"	420	79.5	(100)	Oct.70	49	Rc 2
	LD-20TSF	2 1/2"	550	88.5	(112)	Oct.85	59	Rc 2 1/2
	LD-24TSF	3"	800	89	(140)	Dod.99	75	Rc 3
	LD-32TSF	4"	1140	93	(165)	Dod.131	94	Rc 4
	LD-6TSF	3/4"	310	53	(60.5)	Hex.36	21	Rc 3/4
Copper alloy	LD-8TSF	1"	430	64.5	(61)	Hex.41	26	Rc 1
	LD-10TSF	1 1/4"	730	72.5	(82)	Hex.50	34	Rc 1 1/4
	LD-12TSF	1 1/2"	770	70.5	(90)	Oct.60	39	Rc 1 1/2
	LD-16TSF	2"	990	79.5	(100)	Oct.70	49	Rc 2
	LD-20TSF	2 1/2"	1290	81.5	(113)	Dod.84	61	Rc 2 1/2
	LD-24TSF	3"	1560	87	(139)	Oct.96	77	Rc 3
	LD-32TSF	4"	3590	91	(165)	Oct.126	96	Rc 4
	LD-6TSF	3/4"	225	52	(55)	Oct.32	19	Rc 3/4
	LD-8TSF	1"	350	60	(63)	Oct.41	24	Rc 1
Stainless steel	LD-10TSF	1 1/4"	600	68	(85)	Oct.50	30	Rc 1 1/4
	LD-12TSF	1 1/2"	715	72	(87)	Oct.58	37.5	Rc 1 1/2
	LD-16TSF	2"	940	78.5	(100)	Oct.69	50	Rc 2
	LD-20TSF	2 1/2"	1050	82	(113)	Dod.83	61	Rc 2 1/2
	LD-24TSF	3"	1605	84	(140)	Dod.97	77	Rc 3
	LD-32TSF	4"	2575	94	(167)	Dod.125	97	Rc 4

Before use, please be sure to read "Safety Guide" described at the end of this book and "Instruction Sheet" that comes with the products.



Models and Dimensions

Plug LF type (Male thread)

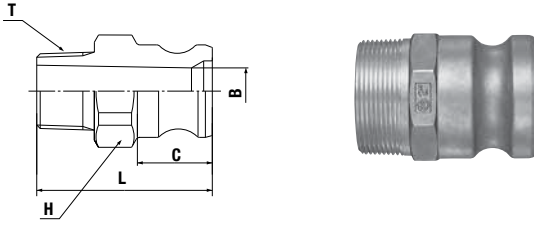

Material	Model	Application (Thread)	Mass (g)	Dimensions (mm)				
				L	C	H(WAF)	øB	T
Aluminum alloy	LF-6TPM	3/4"	70	61	26	Hex.36	16	R 3/4
	LF-8TPM	1"	90	73	34	Hex.41	22	R 1
	LF-10TPM	1 1/4"	140	81	40	Hex.50	28	R 1 1/4
	LF-12TPM	1 1/2"	150	80.5	42	Oct.55	34.5	R 1 1/2
	LF-16TPM	2"	220	89.5	48	Oct.65	44.5	R 2
	LF-20TPM	2 1/2"	370	101	50	Oct.80	56	R 2 1/2
	LF-24TPM	3"	470	106	52	Dod.99	73	R 3
	LF-32TPM	4"	875	116	54	Dod.130	100	R 4
	Copper alloy	LF-6TPM	3/4"	185	59	27	Oct.34	20
LF-8TPM		1"	280	69	32	Oct.41	24	R 1
LF-10TPM		1 1/4"	460	81	40	Hex.50	28	R 1 1/4
LF-12TPM		1 1/2"	500	80.5	42	Oct.55	36	R 1 1/2
LF-16TPM		2"	750	89.5	48	Oct.65	45	R 2
LF-20TPM		2 1/2"	1290	98	50	Dod.83	56	R 2 1/2
LF-24TPM		3"	1480	103	50.8	Dod.96	73	R 3
LF-32TPM		4"	3155	113	53	Dod.126	100	R 4
Stainless steel		LF-6TPM	3/4"	175	59	27	Oct.33	19
	LF-8TPM	1"	255	69	33	Oct.41	24	R 1
	LF-10TPM	1 1/4"	415	80	42	Oct.50	29.5	R 1 1/4
	LF-12TPM	1 1/2"	575	80	40	Oct.58	36.5	R 1 1/2
	LF-16TPM	2"	680	90	46.5	Oct.69	46	R 2
	LF-20TPM	2 1/2"	1020	99	49	Dod.83	56	R 2 1/2
	LF-24TPM	3"	1415	103	51	Dod.96	73	R 3
	LF-32TPM	4"	2275	112	53	Dod.124	100	R 4

Socket LB type (Male thread)

Model LB-6TSM made of aluminum alloy has no rings.

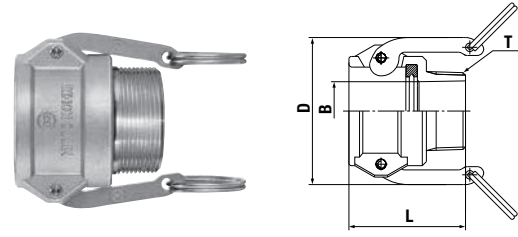

Material	Model	Application (Thread)	Mass (g)	Dimensions (mm)			
				L	D	øB	T
Aluminum alloy	LB-6TSM	3/4"	110	53	(60.5)	(17)	R 3/4
	LB-8TSM	1"	170	65	(61)	(235)	R 1
	LB-10TSM	1 1/4"	310	72	(82)	29.5	R 1 1/4
	LB-12TSM	1 1/2"	340	71.5	(90)	36	R 1 1/2
	LB-16TSM	2"	400	79.5	(100)	(46)	R 2
	LB-20TSM	2 1/2"	530	88.5	(112)	(57.5)	R 2 1/2
	LB-24TSM	3"	715	90	(139)	76	R 3
	LB-32TSM	4"	920	92	(165)	99	R 4
	Copper alloy (Made-to-order item)	LB-6TSM	3/4"	260	52	(53)	19.5
LB-8TSM		1"	355	63	(62)	26	R 1
LB-10TSM		1 1/4"	620	71	(84)	28	R 1 1/4
LB-12TSM		1 1/2"	700	71	(91)	36	R 1 1/2
LB-16TSM		2"	950	81	(100)	51	R 2
LB-20TSM		2 1/2"	1250	86	(113)	63	R 2 1/2
LB-24TSM		3"	1780	92	(139)	78	R 3
LB-32TSM		4"	2540	98	(168)	101	R 4
Stainless steel (Available on request)		LB-6TSM	3/4"	210	52.5	(55)	20
	LB-8TSM	1"	300	63	(63)	25.5	R 1
	LB-10TSM	1 1/4"	520	70.5	(85)	34	R 1 1/4
	LB-12TSM	1 1/2"	580	71.5	(87)	38	R 1 1/2
	LB-16TSM	2"	780	78.5	(101)	50.5	R 2
	LB-20TSM	2 1/2"	980	84	(113)	66	R 2 1/2
	LB-24TSM	3"	1490	92	(139)	78.5	R 3
	LB-32TSM	4"	2080	92	(167)	103.5	R 4

Plug L-PD type (Plug cap)

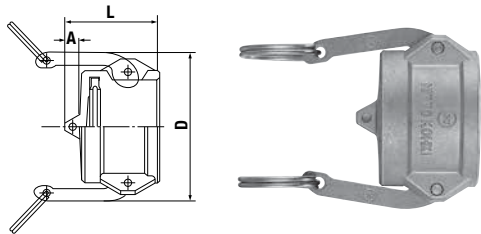

Material	Model	Size	Mass (g)	Dimensions (mm)		
				L	A	D
Aluminum alloy	L-6PD	3/4"	100	46	12	(54)
	L-8PD	1"	145	54	11.5	(62)
	L-10PD	1 1/4"	230	60	13	(83)
	L-12PD	1 1/2"	295	68	17	(91)
	L-16PD	2"	360	68	11	(100)
	L-20PD	2 1/2"	435	72	15	(113)
	L-24PD	3"	690	72	10	(139)
	L-32PD	4"	870	76	15	(167)
	Copper alloy	L-6PD	3/4"	220	45	11
L-8PD		1"	315	53	12	(62)
L-10PD		1 1/4"	610	61	13	(84)
L-12PD		1 1/2"	645	69	17.5	(91)
L-16PD		2"	830	68	11	(100)
L-20PD		2 1/2"	980	71	14	(113)
L-24PD		3"	1380	81	20	(139)
L-32PD		4"	2700	90	26	(168)
Stainless steel		L-6PD	3/4"	180	45	12
	L-8PD	1"	265	52	11	(63)
	L-10PD	1 1/4"	475	60	11	(85)
	L-12PD	1 1/2"	545	63	15	(87)
	L-16PD	2"	720	65	11	(101)
	L-20PD	2 1/2"	945	71	15	(113)
	L-24PD	3"	1420	72	12	(139)
	L-32PD	4"	2055	77	14	(167)

Socket L-SD type (Socket cap)

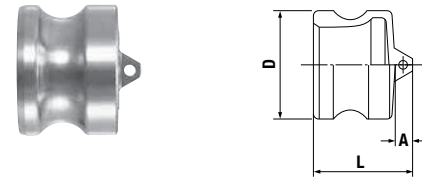

Material	Model	Size	Mass (g)	Dimensions (mm)		
				L	A	øD
Aluminum alloy	L-6SD	3/4"	35	32	8	32
	L-8SD	1"	45	44	10	36.7
	L-10SD	1 1/4"	70	57	14	45.5
	L-12SD	1 1/2"	90	54	15	53.4
	L-16SD	2"	140	62	13	63
	L-20SD	2 1/2"	210	69	20	75.8
	L-24SD	3"	290	71	15	91.5
	L-32SD	4"	960	74	16	119.4
	Copper alloy	L-6SD	3/4"	160	34	8
L-8SD		1"	150	44	10	36.7
L-10SD		1 1/4"	210	55	12	45.5
L-12SD		1 1/2"	290	54	15	53.4
L-16SD		2"	420	61	12	63
L-20SD		2 1/2"	630	69	19	75.7
L-24SD		3"	860	71	15	91.5
L-32SD		4"	1780	74.5	16	119.4
Stainless steel		L-6SD	3/4"	95	39	12
	L-8SD	1"	145	45	12	37
	L-10SD	1 1/4"	250	51	10	45
	L-12SD	1 1/2"	300	54	14	53
	L-16SD	2"	490	59.5	12.5	63
	L-20SD	2 1/2"	710	64	14	76
	L-24SD	3"	930	68	14	92
	L-32SD	4"	1275	68	14	120

Models and Dimensions

Designs and specifications are subject to change for improvement without notice. / WAF : WAF stands for width across flats.

**Plug LE type (Hose barb)**

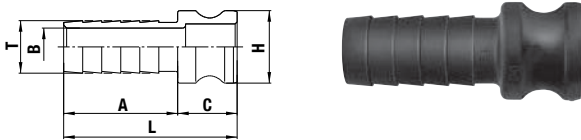

Material	Model	Application (Hose)	Mass (g)	Dimensions (mm)					
				L	A	C	øH	øT	øB
Plastic	LE-6TPH	3/4"	16	74.5	51.5	(23)	(32)	20.7	14.2
	LE-8TPH	1"	29	87.5	57.5	(30)	(36.5)	26.3	19
	LE-12TPH	1 1/2"	73	103	61.5	(41.5)	(53.5)	40	30
	LE-16TPH	2"	122	119	71	(48)	(63)	52.5	41
	LE-24TPH	3"	221	151.5	106.5	(45)	(91.5)	77	64.5

**Socket LC type (Hose barb)**

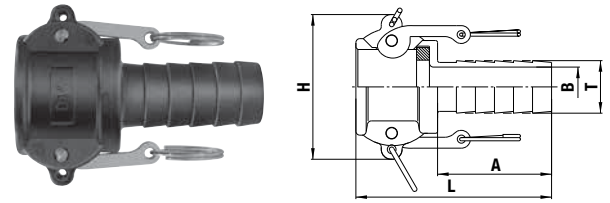

Material	Model	Application (Hose)	Mass (g)	Dimensions (mm)				
				L	A	H	øT	øB
Plastic	LC-6TSH	3/4"	64	83	52	(63.5)	20.2	14
	LC-8TSH	1"	104	97.5	56.5	(73)	26.2	20
	LC-12TSH	1 1/2"	242	109.5	58	(95)	39	29.5
	LC-16TSH	2"	269	125	70.5	(105.5)	52.5	41
	LC-24TSH	3"	527	161	102	(136.5)	77	64.5

**Plug LA type (Female thread)**



Material	Model	Application (Thread)	Mass (g)	Dimensions (mm)				
				L	C	H(WAF)	øB	T
Plastic	LA-6TPF	3/4"	19	42	(26)	Hex.34	21.3	Rc 3/4
	LA-8TPF	1"	27	59	(34)	Hex.43	22	Rc 1
	LA-12TPF	1 1/2"	65	67	(42)	Ribbed 65	34	Rc 1 1/2
	LA-16TPF	2"	102	73	(47.5)	Ribbed 78	42	Rc 2
	LA-24TPF	3"	211	90	(52.5)	Ribbed 108	71	Rc 3

**Socket LD type (Female thread)**

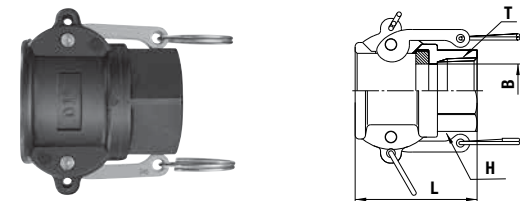

Material	Model	Application (Thread)	Mass (g)	Dimensions (mm)			
				L	H(WAF)	øB	T
Plastic	LD-6TSF	3/4"	65	49	Hex.32	21.5	Rc 3/4
	LD-8TSF	1"	98	61	Hex.41	27	Rc 1
	LD-12TSF	1 1/2"	260	77.5	Ribbed 68	39	Rc 1 1/2
	LD-16TSF	2"	285	83	Ribbed 80	51	Rc 2
	LD-24TSF	3"	444	90.5	Ribbed 109	77.5	Rc 3

**Plug LF type (Male thread)**

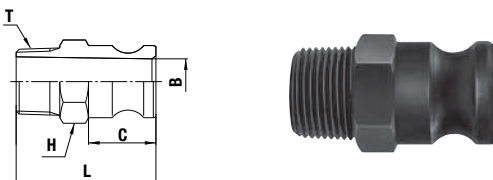

Material	Model	Application (Thread)	Mass (g)	Dimensions (mm)				
				L	C	H(WAF)	øB	T
Plastic	LF-6TPM	3/4"	23	60	(26)	Hex.32	19	R 3/4
	LF-8TPM	1"	19	71	(34)	Hex.37	23	R 1
	LF-12TPM	1 1/2"	72	77	(42)	Ribbed 63	32	R 1 1/2
	LF-16TPM	2"	105	84.5	(48)	Ribbed 74	44.5	R 2
	LF-24TPM	3"	210	102.5	(51.5)	Ribbed 100	72	R 3

**Socket LB type (Male thread)**

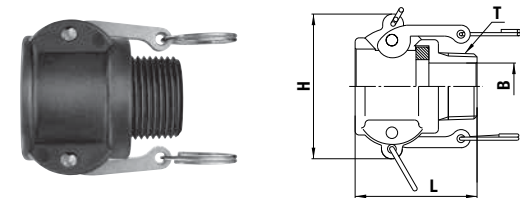

Material	Model	Application (Thread)	Mass (g)	Dimensions (mm)			
				L	H	øB	T
Plastic	LB-6TSM	3/4"	58	49.5	(63.5)	19	R 3/4
	LB-8TSM	1"	88	61	(73)	23.5	R 1
	LB-12TSM	1 1/2"	227	77.5	(95)	37	R 1 1/2
	LB-16TSM	2"	251	82.5	(105.5)	48	R 2
	LB-24TSM	3"	397	88	(136.5)	75	R 3

**Plug L-PD type (Plug cap)**

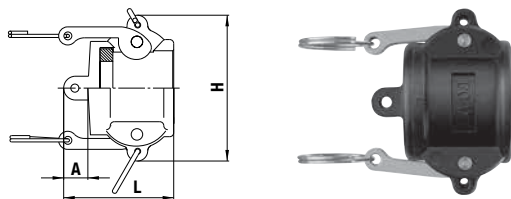

Material	Model	Size	Mass (g)	Dimensions (mm)		
				L	A	H
Plastic	L-6PD	3/4"	60	45	12	(63.5)
	L-8PD	1"	94	55.5	12	(73)
	L-12PD	1 1/2"	214	65	15	(95)
	L-16PD	2"	219	70.5	16	(106)
	L-24PD	3"	408	77	17.5	(136)

**Socket L-SD type (Socket cap)**



Material	Model	Size	Mass (g)	Dimensions (mm)		
				L	A	øD
Plastic	L-6SD	3/4"	10	35.5	12	(32.1)
	L-8SD	1"	18	42.5	11	(36.5)
	L-12SD	1 1/2"	46	53.5	14	(53.2)
	L-16SD	2"	68	63	16	(63)
	L-24SD	3"	102	71	17.5	(109)

Before use, please be sure to read "Safety Guide" described at the end of this book and "Instruction Sheet" that comes with the products.

## For Medium Pressure

# TSP CUPLA

### For medium pressure general applications

#### Working pressure



1.5 to 7.5 MPa  
(15 to 76 kgf/cm<sup>2</sup>)

#### Valve structure



Straight through

Applicable fluids for braided hose connection type depend upon the specifications of braided hoses to be used.

#### Applicable fluids



Note: Depending on the temperature of steam / hot water, the heat may damage seal materials.

**Valveless structure suits high viscosity fluids! Various body materials, sizes and end configurations. Braided hose connection types are newly added.**

- Valveless construction drastically saves pressure loss and achieves high flow rate.
- Suitable for high viscosity fluids (such as grease).
- Available in various standard body materials, sizes and end configurations to cope with diversified applications and operating situations.
- No hose clamp required! Simple and secure connection to braided hose.

Note: See the pages of Seal Material Selection Table at the end of this catalog for the suitability of seal materials to fluids.



For connection to braided hoses



### Specifications

Body material	Brass				Stainless steel (SUS304), Steel (Nickel plated)						
Size (Thread and hose)	1/8", 1/4" 3/8", 1/2"	3/4" 1"	1 1/4" 1 1/2"	2"	1/8", 1/4" 3/8", 1/2"	3/4" 1"	1 1/4" 1 1/2"	2"			
Working pressure	MPa	5.0	3.0	2.0	1.5	7.5	4.5	3.0	2.0		
	kgf/cm <sup>2</sup>	51	31	20	15	76	46	31	20		
	bar	50	30	20	15	75	45	30	20		
	PSI	725	435	290	218	1090	653	435	290		
Seal material	Seal material	Nitrile rubber		Fluoro rubber		Ethylene-propylene rubber		Mark	NBR (SG)	FKM (X-100)	EPDM (EPT)
	Working temperature range	-20°C to +80°C		-20°C to +180°C		-40°C to +150°C		Remarks	Standard material		

- SUS316 is available as option.
- Maximum working pressure and working temperature range of TSP CUPLA for braided hoses depend upon the specifications of braided hoses to be used.
- Seal material available for braided hoses is nitrile rubber only.
- Seal material available for steel body is nitrile rubber only.

### Maximum Tightening Torque

Size (Thread)		Nm {kgf·cm}								
Torque	Steel	9 {92}	14 {143}	22 {224}	60 {612}	90 {918}	120 {1224}	260 {2652}	280 {2856}	500 {5100}
	Brass	5 {51}	9 {92}	12 {122}	30 {306}	50 {510}	65 {663}	150 {1530}	160 {1632}	260 {2652}
	Stainless steel	9 {92}	14 {143}	22 {224}	60 {612}	90 {918}	120 {1224}	260 {2652}	280 {2856}	500 {5100}

- Tighten the nut for braided hoses until it is flush against the hose barb base.

### Flow Direction

Fluid flow can be bi-directional when socket and plug are connected.



### Interchangeability

Sockets and plugs can be connected regardless of end configurations if the first number(s) of the model is the same.

### Minimum Cross-Sectional Area

Model	(mm <sup>2</sup> )											
End configurations	1TSP	2TSP	3TSP	4TSP	6TSP	8TSP	10TSP	12TSP	16TSP			
H type (Hose barb)	7.0 (ø3)	19.6 (ø5)	38.4 (ø7)	78.5 (ø10)	176 (ø15)	283 (ø19)	530 (ø26)	804 (ø32)	1256 (ø40)			
M type / F type (Male thread / Female thread)	15.9 (ø4.5)	33.1 (ø6.5)	78.5 (ø10)	132 (ø13)	226 (ø17)	452 (ø24)	804 (ø32)	1134 (ø38)	1885 (ø49)			
Model	2TSN-60 2TPN-60		3TSN-90 3TPN-90		4TSN-120 4TPN-120		4TSN-150 4TPN-150		6TSN-190 6TPN-190		8TSN-250 8TPN-250	
End configurations	N type (For braided hose connection)		23.7 (ø5.5)	56.7 (ø8.5)	95.0 (ø11)	132 (ø13)	226 (ø17)	415 (ø23)				

### Suitability for Vacuum

1.3 x 10<sup>-1</sup> Pa {1 x 10<sup>-3</sup> mmHg}

Socket only	Plug only	When connected
—	—	Operational

### Flow Rate – Pressure Loss Characteristics

[Test conditions] • Fluid : Hydraulic oil • Temperature : 30°C±10°C  
• Fluid viscosity : 32 x 10<sup>-6</sup> m<sup>2</sup>/s • Density : 0.87 x 10<sup>3</sup> kg/m<sup>3</sup>

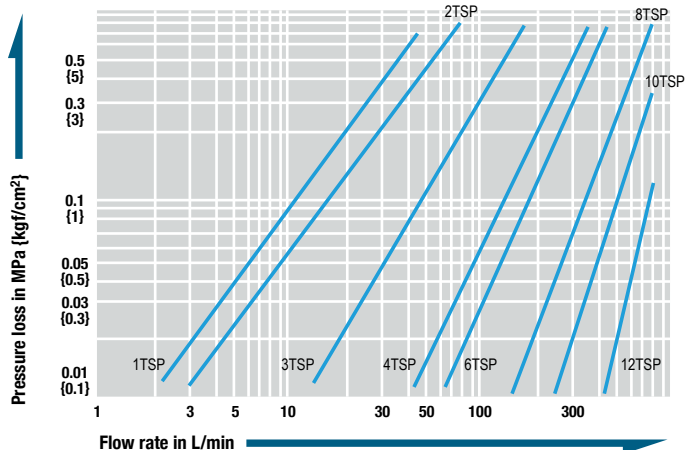

Models and Dimensions

**Plug TPH type (Hose barb)**

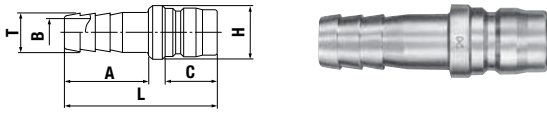

Model	Application (Hose)	Mass (g)			Dimensions (mm)					
		Steel	Brass	Stainless steel	L	ØH	A	C	ØT	ØB
1TPH	1/8"	12 <sup>+1</sup>	13	12	41	12	20	15.5	6.5	3
2TPH	1/4"	21	23	21	53	14	29	18	8	5
3TPH	3/8"	38	41	38	60	18	32	21	11	7
4TPH	1/2"	71	77	71	70	22	39	24	15	10
6TPH	3/4"	134	146	135	84	28	48	28	21	15
8TPH	1"	327	356	329	105	40	57	36	27	19
10TPH	1 1/4"	495	530	500	121	48	70	39	34.5	26
12TPH	1 1/2"	665	715	660	132	55	75	45	41	32
16TPH	2"	1,330	1,430	1,345	142	70	80	51	54	40

**Plug TPM type (Male thread)**



Model	Application (Thread)	Mass (g)			Dimensions (mm)					
		Steel	Brass	Stainless steel	L	H(WAF)	C	T	ØB	
1TPM	Rc 1/8	16 <sup>+1</sup>	17	17	32	Hex.12	15.5	R 1/8	4.5	
2TPM	Rc 1/4	30	33	30	38	Hex.17	18	R 1/4	6.5	
3TPM	Rc 3/8	38	42	38	43	Hex.17	21	R 3/8	10	
4TPM	Rc 1/2	81	88	81	52	Hex.22	24	R 1/2	13	
6TPM	Rc 3/4	164	179	165	59	Hex.32	28	R 3/4	17	
8TPM	Rc 1	273	297	274	73	Hex.41	36	R 1	25	
10TPM	Rc 1 1/4	520	560	530	83	Hex.50	39	R 1 1/4	32	
12TPM	Rc 1 1/2	655	705	665	93	Hex.54 <sup>+2</sup>	45	R 1 1/2	38	
16TPM	Rc 2	1,240	1,345	1,250	102	75 x Ø80	51	R 2	50	

**Plug TPF type (Female thread)**

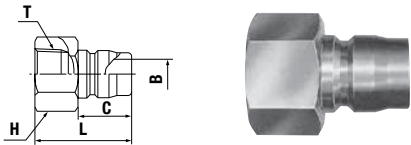

Model	Application (Thread)	Mass (g)			Dimensions (mm)					
		Steel	Brass	Stainless steel	L	H(WAF)	C	T	ØB	
1TPF	R 1/8	14 <sup>+1</sup>	15	14	26	Hex.14	15.5	Rc 1/8	4.5	
2TPF	R 1/4	28	31	29	34	Hex.17	18	Rc 1/4	6.5	
3TPF	R 3/8	43	47	43	38	Hex.21	21	Rc 3/8	10	
4TPF	R 1/2	103	113	104	45	Hex.29	24	Rc 1/2	13	
6TPF	R 3/4	166	181	167	51	Hex.35	28	Rc 3/4	17	
8TPF	R 1	321	350	323	60	Hex.41	36	Rc 1	26	
10TPF	R 1 1/4	567	615	573	64	Hex.54 <sup>+3</sup>	39	Rc 1 1/4	32	
12TPF	R 1 1/2	703	763	630	75	Hex.58 <sup>+4</sup>	45	Rc 1 1/2	38	
16TPF	R 2	1,226	1,374	1,190	83	77 x Ø82	51	Rc 2	50	

**Plug TPN type (For braided hose connection)**

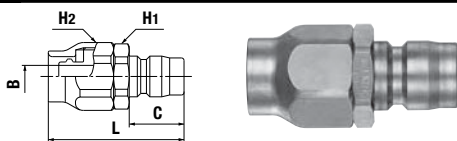

Model	Application (Hose) <sup>5</sup>		Mass (g)		Dimensions (mm)					
	Size (mm)	Hose wall thickness (mm)	Brass	Stainless steel	L	H1(WAF)	H2(WAF)	C	ØB	
2TPN-60	Ø6 x Ø11	2.5±0.25	60	55	(47)	Hex.19	Hex.19	18	5.5	
3TPN-90	Ø9 x Ø15	3±0.3	93	87	(52)	Hex.23	Hex.24	21	8.5	
4TPN-120	Ø12 x Ø18		140	130	(60)	Hex.27	Hex.27	24	11	
4TPN-150	Ø15 x Ø22	3.5±0.35	182	170	(68)	Hex.30	Hex.30	24	13	
6TPN-190	Ø19 x Ø26		261	245	(76)	Hex.35	Hex.35	28	17	
8TPN-250	Ø25 x Ø33	4±0.4	461	427	(96)	Hex.41	Hex.41	36	23	

**Socket TSH type (Hose barb)**

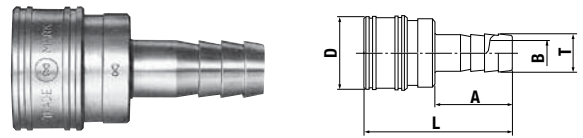

Model	Application (Hose)	Mass (g)			Dimensions (mm)					
		Steel	Brass	Stainless steel	L	ØD	A	ØT	ØB	
1TSH	1/8"	24 <sup>+1</sup>	26	24	40	17.5	20	6.5	3	
2TSH	1/4"	63	69	64	55	24	29	8	5	
3TSH	3/8"	95	104	96	62	28	32	11	7	
4TSH	1/2"	176	192	177	74	35	39	15	10	
6TSH	3/4"	348	379	350	90	45	48	21	15	
8TSH	1"	570	605	570	102	58	57	27	19	
10TSH	1 1/4"	840	910	850	117	69	70	34.5	26	
12TSH	1 1/2"	1,060	1,140	1,070	128	75	75	41	32	
16TSH	2"	2,095	2,251	2,100	141	98	80	54	40	

**Socket TSM type (Male thread)**

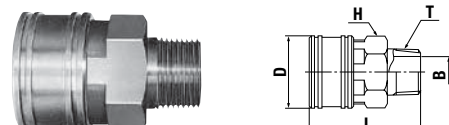

Model	Application (Thread)	Mass (g)			Dimensions (mm)					
		Steel	Brass	Stainless steel	L	ØD	H(WAF)	T	ØB	
1TSM	Rc 1/8	25 <sup>+1</sup>	27	26	30	17.5	Hex.14	R 1/8	4.5	
2TSM	Rc 1/4	66	72	67	42	24	Hex.19	R 1/4	6.5	
3TSM	Rc 3/8	99	108	100	46	28	Hex.23	R 3/8	10	
4TSM	Rc 1/2	178	194	179	56	35	Hex.29	R 1/2	13	
6TSM	Rc 3/4	343	374	346	65	45	Hex.38	R 3/4	18	
8TSM	Rc 1	629	665	633	76	58	Hex.50	R 1	24	
10TSM	Rc 1 1/4	950	1,010	955	86	69	54 x Ø64	R 1 1/4	32	
12TSM	Rc 1 1/2	1,180	1,275	1,190	95	75	58 x Ø70	R 1 1/2	38	
16TSM	Rc 2	2,040	2,190	2,060	108	98	77 x Ø82	R 2	49	

**Socket TSF type (Female thread)**



Model	Application (Thread)	Mass (g)			Dimensions (mm)			
		Steel	Brass	Stainless steel	L	ØD	H(WAF)	T
1TSF	R 1/8	25 <sup>+1</sup>	27	25	27	17.5	Hex.14	Rc 1/8
2TSF	R 1/4	57	62	57	32	24	Hex.19	Rc 1/4
3TSF	R 3/8	83	90	83	35	28	Hex.23	Rc 3/8
4TSF	R 1/2	153	167	154	42	35	Hex.29	Rc 1/2
6TSF	R 3/4	288	314	289	48	45	Hex.38	Rc 3/4
8TSF	R 1	575	607	575	59	58	Hex.50	Rc 1
10TSF	R 1 1/4	821	888	825	64	69	54 x Ø64	Rc 1 1/4
12TSF	R 1 1/2	1,003	1,064	1,005	71	75	58 x Ø70	Rc 1 1/2
16TSF	R 2	1,765	1,880	1,770	80	98	77 x Ø82	Rc 2

**Socket TSN type (For braided hose connection)**

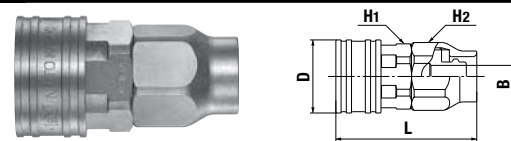

Model	Application (Hose) <sup>5</sup>		Mass (g)		Dimensions (mm)					
	Size (mm)	Hose wall thickness (mm)	Brass	Stainless steel	L	ØD	H1(WAF)	H2(WAF)	ØB	
2TSN-60	Ø6 x Ø11	2.5±0.25	91	84	(49)	24	Hex.19	Hex.19	5.5	
3TSN-90	Ø9 x Ø15	3±0.3	139	129	(54)	28	Hex.23	Hex.24	8.5	
4TSN-120	Ø12 x Ø18		222	206	(62)	35	Hex.29	Hex.27	11	
4TSN-150	Ø15 x Ø22	3.5±0.35	255	237	(70)	35	Hex.30	Hex.30	13	
6TSN-190	Ø19 x Ø26		435	408	(81)	45	Hex.38	Hex.35	17	
8TSN-250	Ø25 x Ø33	4±0.4	677	633	(93)	58	Hex.50	Hex.41	23	







\*1 : 1TSP steel is a made-to-order item. \*2 : Stainless steel: 54 x Ø60 \*3 : Stainless steel: 54 x Ø59 \*4 : Stainless steel: 58 x Ø65 \*5 : Braided hoses for TPN type and TSN type should be made of soft PVC and woven by reinforcement thread. Before use, please be sure to read "Safety Guide" described at the end of this book and "Instruction Sheet" that comes with the products.



For Low Pressure

# TSP CUPLA Socket with Ball Valve

For low pressure general applications

<b>Working pressure</b>	<b>Valve structure</b>	<b>Applicable fluids</b>			
 1.0 MPa {10 kgf/cm <sup>2</sup> }	 One-way shut-off				
		Water	Hydraulic oil	Air	Gas

One-piece design of TSP CUPLA socket and ball valve. Sleeve stopper mechanism prevent accidental disconnection during connection. (when the valve is open.)

- Socket valve can be opened and shut off while socket and plug are connected.
- Ball valve design provides for high flow rate.
- High viscosity fluids such as grease can be applied.

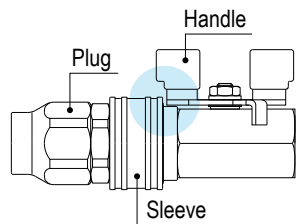

The handle of the ball valve locks the sleeve to prevent disconnection of the plug during use.

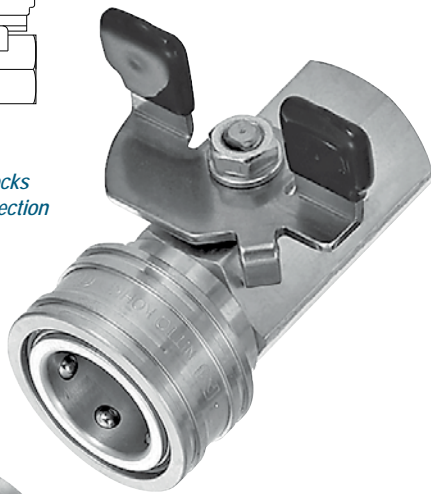

Interchangeable with standard TSP CUPLA plug in the same size.

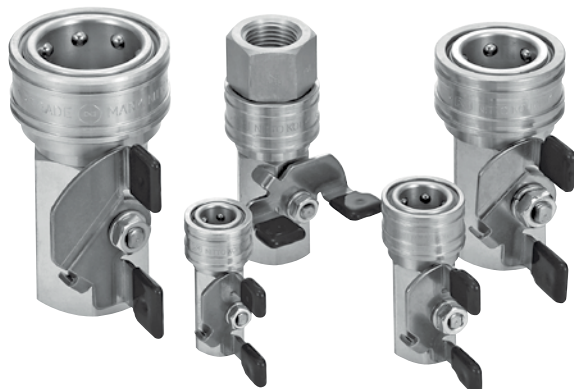

Specifications					
Model	BV-2TSF	BV-3TSF	BV-4TSF	BV-6TSF	BV-8TSF
Size (Thread)	1/4"	3/8"	1/2"	3/4"	1"
Body material	Brass				
Pressure unit	MPa	kgf/cm <sup>2</sup>	bar	PSI	
Working pressure	1.0	10	10	145	
Seal material		Seal material	Mark	Working temperature range	
Working temperature range	CUPLA Part	Fluoro rubber	FKM	-5°C to +120°C	
	Ball Valve Part	Fluoropolymer resin	-		

Maximum Tightening Torque					Nm {kgf·cm}
Model	BV-2TSF	BV-3TSF	BV-4TSF	BV-6TSF	BV-8TSF
Torque	9 {92}	12 {122}	30 {306}	50 {510}	65 {663}

**Flow Direction**

Fluid flow can be bi-directional when socket and plug are connected.

**Interchangeability**

TSP CUPLA plugs of the same size can be connected regardless of end configurations.

Minimum Cross-Sectional Area					(mm <sup>2</sup> )
Model	BV-2TSF	BV-3TSF	BV-4TSF	BV-6TSF	BV-8TSF
Min. cross-sectional area	19.6	44.1	63.6	122	201

\* Value of BV type only. The minimum cross-sectional area may vary depending upon the end configuration of the plug.

**Suitability for Vacuum**

Not suitable for vacuum application in either connected or disconnected condition.

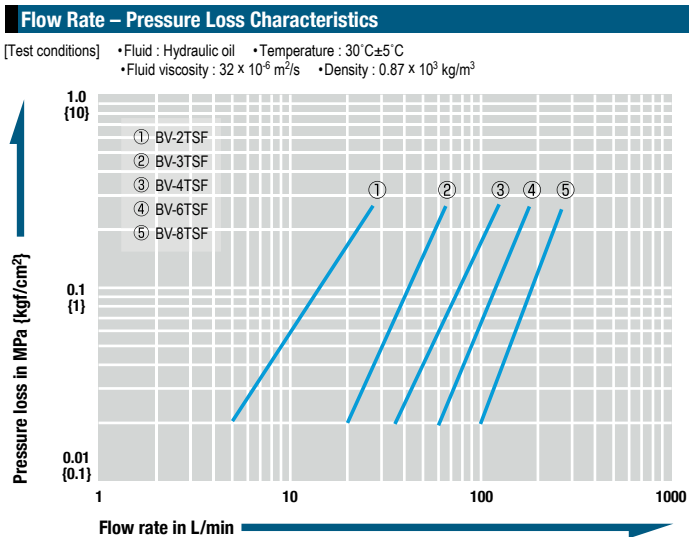

**Ball Valve Open**

Sleeve is locked.

**Ball Valve Shut**

Sleeve is free.

Models and Dimensions

WAF: WAF stands for width across flats.

Socket BV-TSF type (Female thread)

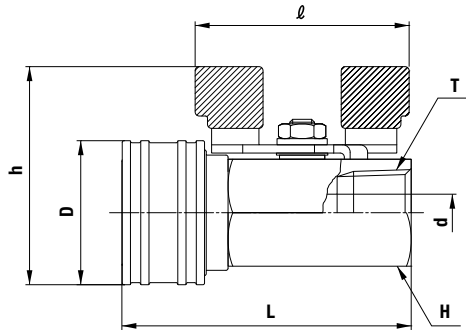
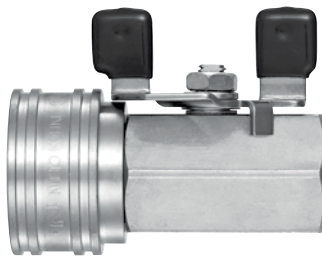

Model	Application (Thread)	Mass (g)	Dimensions (mm)						
			L	h	øD	H(WAF)	T	ød	ℓ
BV-2TSF	R 1/4	104	(52.3)	(43)	24	Hex.17	Rc 1/4	5	(38.5)
BV-3TSF	R 3/8	163	(60.5)	(47.5)	28	Hex.21	Rc 3/8	7.5	(44)
BV-4TSF	R 1/2	270	(70.3)	(53)	35	Hex.26	Rc 1/2	9	(52)
BV-6TSF	R 3/4	491	(82.8)	(66.1)	45	Hex.32	Rc 3/4	12.5	(60.5)
BV-8TSF	R 1	904	(102.3)	(76.6)	58	Hex.41	Rc 1	16	(76)

Application

TSP CUPLA Socket with Ball Valve

TSP CUPLA Socket + Commercially Available Ball Valve

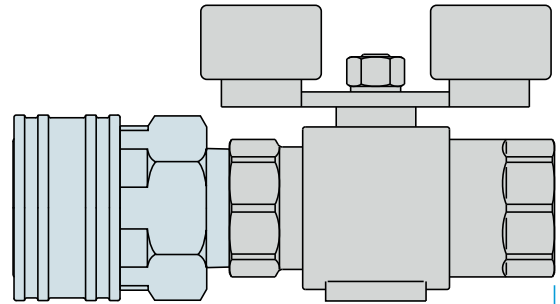

Overall length reduced by around 30%

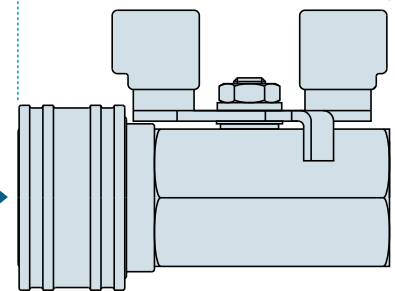

Compact and enhanced sealing design

Connection part between a Standard TSP CUPLA socket and a commercially available ball valve is eliminated for enhanced sealing and the overall length is reduced by around 30%.

Accessory

CUPLA ADAPTER for Braided Hose Connection

Can be screwed into CUPLA with female threads, 3/8", 1/2", 3/4"



See page 152 for the details.

For Medium Pressure

# SP CUPLA

## Type A

For medium pressure general applications

Working pressure



1.5 to 7.5 MPa  
(15 to 76 kgf/cm<sup>2</sup>)

Valve structure



Two-way shut-off

Applicable fluids



Note: Depending on the temperature of steam / hot water, the heat may damage seal materials.

For medium pressure applications, with automatic shut-off valves in both socket and plug. Various body materials, sizes and end configurations. Plugs with male thread end are also available.

- Automatic shut-off valves in both socket and plug prevent fluid spill out on disconnection.
- Available in various standard body materials, sizes and end configurations to cope with diversified applications and operating situations.



### New self-aligned valve design provides better seal

The new design of the valve head makes smooth self-aligned return to its original position when socket and plug are disconnected. This mechanism enhances safety sealing of individual socket or plug when disconnected (1 to 8SP-A Type).



### Specifications

Body material	Brass				Stainless steel (SUS304), Steel (Nickel plated)												
Size (Thread)	1/8", 1/4" 3/8"	1/2", 3/4" 1"	1 1/4" 1 1/2"	2"	1/8", 1/4" 3/8"	1/2", 3/4" 1"	1 1/4" 1 1/2"	2"									
Working pressure	MPa	5.0	3.0	2.0	1.5	7.5	4.5	3.0	2.0								
	kgf/cm <sup>2</sup>	51	31	20	15	76	46	31	20								
	bar	50	30	20	15	75	45	30	20								
	PSI	725	435	290	218	1090	653	435	290								
Seal material * Working temperature range	Seal material	Nitrile rubber		Fluoro rubber		Ethylene-propylene rubber		Mark	NBR (SG)	FKM (X-100)	EPDM (EPT)	Working temperature range	-20°C to +80°C	-20°C to +180°C	-40°C to +150°C	Remarks	Standard material

\* Plugs with male thread with nitrile rubber or ethylene-propylene rubber are made-to-order items.

\* Seal material available for steel body is nitrile and fluoro rubber.

### Maximum Tightening Torque

Size (Thread)		Nm {kgf·cm}									
Torque	Steel	1/8"	9 {92}	14 {143}	22 {224}	60 {612}	90 {918}	120 {1224}	260 {2652}	280 {2856}	500 {5100}
		Brass	1/4"	5 {51}	9 {92}	12 {122}	30 {306}	50 {510}	65 {663}	150 {1530}	180 {1836}
	Stainless steel		3/8"	9 {92}	14 {143}	22 {224}	60 {612}	90 {918}	120 {1224}	260 {2652}	280 {2856}
		1/2"	22 {224}	60 {612}	90 {918}	120 {1224}	260 {2652}	280 {2856}	500 {5100}		

Plug with male thread type is only available in brass material.

### Flow Direction

Fluid flow can be bi-directional when socket and plug are connected.



### Interchangeability

Socket and plug of different sizes cannot be connected.

Interchangeable with conventional SP CUPLA in the same size.

\*Can be connected with SP-V CUPLA but take heed of flow rate change.

### Minimum Cross-Sectional Area

Model	1SP-A	2SP-A	3SP-A	4SP-A	6SP-A	8SP-A	10SP-A	12SP-A	16SP-A
Min. cross-sectional area	14	26	51	73	178	229	395	553	803

### Suitability for Vacuum

1.3 x 10<sup>-1</sup> Pa {1 x 10<sup>-3</sup> mmHg}

Socket only	Plug only	When connected
—	—	Operational

### Admixture of Air on Connection

May vary depending upon the usage conditions.

Model	1SP-A	2SP-A	3SP-A	4SP-A	6SP-A	8SP-A	10SP-A	12SP-A	16SP-A
Volume of air admixture	0.6	1.1	2.7	3.9	11	17	29	45	84

### Volume of Spillage per Disconnection

May vary depending upon the usage conditions.

Model	1SP-A	2SP-A	3SP-A	4SP-A	6SP-A	8SP-A	10SP-A	12SP-A	16SP-A
Volume of spillage	0.4	0.8	2.1	3.4	9.5	15	29	45	84

### Flow Rate – Pressure Loss Characteristics

[Test conditions] • Fluid : Water • Temperature: 25°C±5°C

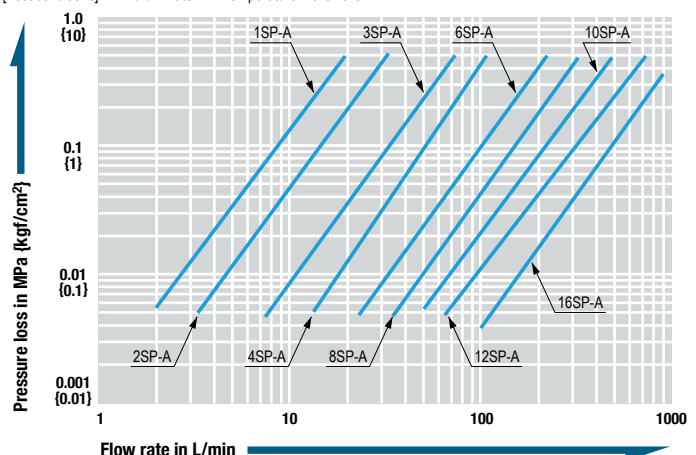

Models and Dimensions

**Plug Female thread**

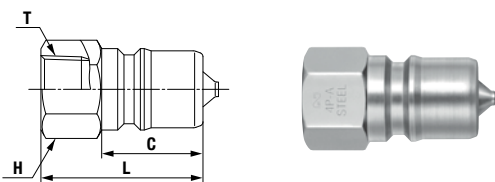

Model	Application (Thread)	Mass (g)			Dimensions (mm)			
		Steel	Brass	Stainless steel	L	C	H(WAF)	T
1P-A	R 1/8	17 *1	19	17	29	19	Hex.14	Rc 1/8
2P-A	R 1/4	32	34	32	36	22	Hex.17	Rc 1/4
3P-A	R 3/8	56	61	56	40	25	Hex.21	Rc 3/8
4P-A	R 1/2	112	121	112	44	28	Hex.29	Rc 1/2
6P-A	R 3/4	190	205	190	52	36	Hex.35	Rc 3/4
8P-A	R 1	311	333	310	62	40	Hex.41	Rc 1
10P-A	R 1 1/4	590	630	620	70	45	Hex.54 *2	Rc 1 1/4
12P-A	R 1 1/2	870	920	880	75	49	Hex.63 *3	Rc 1 1/2
16P-A	R 2	1540	1640	1560	80	52	77 x ø84	Rc 2

\* The photos above show steel coupling. • The appearance of stainless steel coupling (SUS304) differs slightly from that shown in the photos above.

\*1 1P-A (Steel) and 1S-A (Steel) are made-to-order items. \*2 Stainless steel: 54 x ø59 \*3 Stainless steel: 63 x ø67

**Socket Female thread**

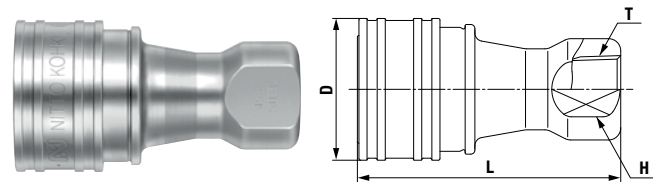

Model	Application (Thread)	Mass (g)			Dimensions (mm)			
		Steel	Brass	Stainless steel	L	øD	H(WAF)	T
1S-A	R 1/8	73 *1	79	75	48	24	14	Rc 1/8
2S-A	R 1/4	119	128	130	58	28	19	Rc 1/4
3S-A	R 3/8	187	202	193	65	35	21	Rc 3/8
4S-A	R 1/2	368	397	391	72	45	29	Rc 1/2
6S-A	R 3/4	639	686	645	88	55	35	Rc 3/4
8S-A	R 1	951	1024	962	102	65	41	Rc 1
10S-A	R 1 1/4	1430	1520	1440	115	77	54	Rc 1 1/4
12S-A	R 1 1/2	2130	2270	2150	124	88	63	Rc 1 1/2
16S-A	R 2	3280	3510	3310	132	108	77	Rc 2

**Plug Male thread**

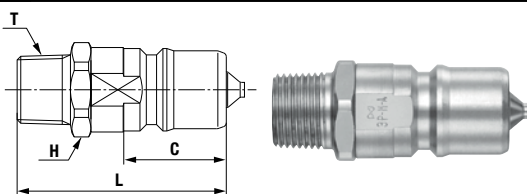

Model	Application (Thread)	Mass (g)			Dimensions (mm)			
		Brass			L	C	H(WAF)	T
1P-M-A	Rc 1/8	24			(40)	19	Hex.14	R 1/8
2P-M-A	Rc 1/4	41			(44)	22	Hex.17	R 1/4
3P-M-A	Rc 3/8	71			(51)	25	Hex.21	R 3/8
4P-M-A	Rc 1/2	149			(62)	28	Hex.27	R 1/2
6P-M-A	Rc 3/4	295			(75)	36	Hex.35	R 3/4
8P-M-A	Rc 1	406			(83)	40 *4	Hex.41	R 1

\*4 Model 8P-M-A indicates an approximate insertion length because there is no difference in level on the body.

Accessory

**CUPLA ADAPTER for Braided Hose Connection**

Can be screwed into CUPLA with female threads, 3/8", 1/2", 3/4"



See page 152 for the details.

**SLEEVE STOPPER for SP CUPLA Type A**

• Sleeve stopper exclusively for SP CUPLA Type A sockets. Attaching the sleeve stopper after connection of socket and plug locks the sleeve of the socket and prevents unexpected disconnection.

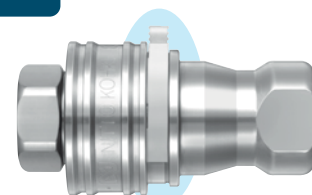
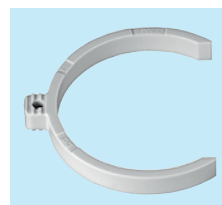

Attached to SP CUPLA Type A

See page 151 for the details.



# For Medium Pressure

# HOT WATER CUPLA

## HW Type

For temperature control piping

Working pressure



Valve structure



Applicable fluids\*



\* This product is designed for use with water from -20°C to +180°C. When used with other fluids, check the suitability of the seal and body material.

The most suitable rubber for hot water adopted. Best suited for hot water applications such as plastic moldings.

- The safety lock function prevents accidental disconnection caused by vibration or impact.
- Nickel plated on the liquid contact parts to improve corrosion resistance.
- The socket has double O-ring for improved seal.



### Safety lock function (Sleeve lock)



#### How to lock

Slide the Lock Ring in the direction of the arrow A and rotate it simultaneously. When the Stopper is aligned with the shallower cutout on the Lock Ring, the CUPLA will be locked.

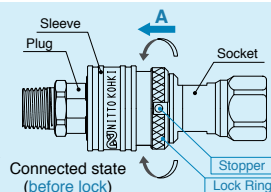

#### How to unlock

Slide the Lock Ring in the direction of the arrow A and rotate it simultaneously. When the Stopper is aligned with the deeper cutout on the Lock Ring, the CUPLA will be unlocked.

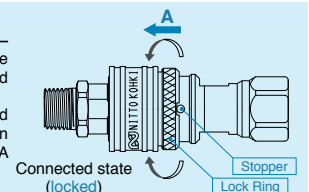

Specifications				
Body material	Brass (Nickel plated)			
Size (Thread)	Plug : R 1/4, R 3/8, R 1/2 / Socket : Rc 1/4, Rc 3/8, Rc 1/2			
Pressure unit	MPa	kgf/cm <sup>2</sup>	bar	PSI
Working pressure	2.0	20	20	290
Seal material	Seal material	Mark	Working temperature range	Remarks
Working temperature range	Fluoro rubber	FKM (X-100)	-20°C to +180°C	Standard material

Maximum Tightening Torque			
Size (Thread)	Nm {kgf·cm}		
1/4"	9 {92}	12 {122}	30 {306}

On installation or removal always use correct size spanner / wrench on the hexagon section of socket/plug body.



**Interchangeability**  
 Socket and plug of different sizes cannot be connected. SP CUPLA Type A and HW Type CUPLA of the same size can be connected regardless of end configurations. However, SP CUPLA Type A has different seal material characteristics, so the product specification and durability will differ. Conduct performance evaluation test under your actual operating environment and conditions within range of the working conditions of the product.

Minimum Cross-Sectional Area (mm <sup>2</sup> )			
Model	HW-2S-F × HW-2P-M	HW-3S-F × HW-3P-M	HW-4S-F × HW-4P-M
Min. Cross-sectional area	26	51	73

Suitability for Vacuum 1.3 × 10 <sup>-1</sup> Pa {1 × 10 <sup>-3</sup> mmHg}		
Socket only	Plug only	When connected
—	—	Operational

Admixture of Air on Connection May vary depending upon the usage conditions. (mL)			
Model	HW-2S-F × HW-2P-M	HW-3S-F × HW-3P-M	HW-4S-F × HW-4P-M
Volume of air	1.2	2.7	3.9

Volume of Spillage per Disconnection May vary depending upon the usage conditions. (mL)			
Model	HW-2S-F × HW-2P-M	HW-3S-F × HW-3P-M	HW-4S-F × HW-4P-M
Volume of spillage	0.8	2.1	3.2

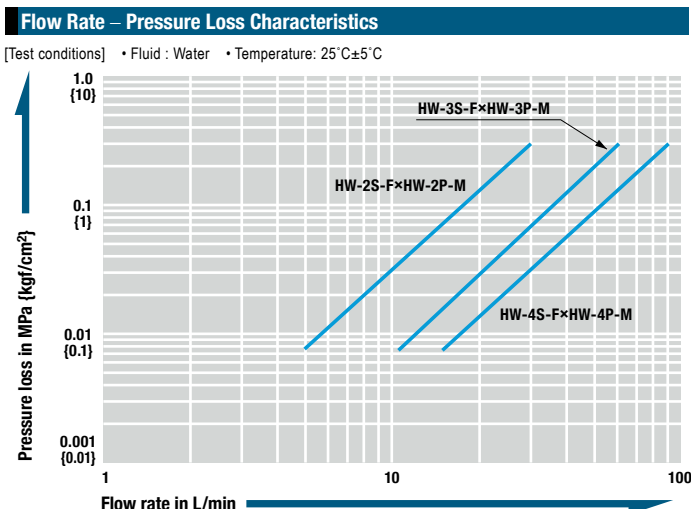

Models and Dimensions

**Plug Male thread**

Model	Application (Thread)	Mass (g)	Dimensions (mm)				
			L	C	øD	H (WAF)	T
HW-2P-M	Rc 1/4	41	(44)	22	18.5	Hex.17	R 1/4
HW-3P-M	Rc 3/8	71	(51)	25	23	Hex.21	R 3/8
HW-4P-M	Rc 1/2	149	(62)	28	30	Hex.27	R 1/2

**Socket Female thread**

Model	Application (Thread)	Mass (g)	Dimensions (mm)			
			L	øD	H (WAF)	T
HW-2S-F	R 1/4	150	(66)	28	Hex.19	Rc 1/4
HW-3S-F	R 3/8	247	(74)	35	Hex.24	Rc 3/8
HW-4S-F	R 1/2	480	(87)	45	Hex.30	Rc 1/2

Approximate time for Valve / O-ring replacement

\*Test results by us

Test conditions

• Testing device: Mold temperature controlling machine • Fluid: Clean water • Test temperature: 160°C, 180°C • Test condition: Continuous test with the CUPLA connected

**Valve**

- when 180°C** Please replace the whole CUPLA in approximately 1000 hours. The valve cannot be replaced.
- when 160°C** Please replace the whole CUPLA in approximately 3000 hours. The valve cannot be replaced.

**O-ring**

- when 180°C** Please replace the O-rings of the Socket in approximately 700 hours. Please replace the two O-rings at once.
- when 160°C** Please replace the O-rings of the Socket in approximately 2000 hours. Please replace the two O-rings at once.

**Hot water 180°C** → After 1000 hours of use

**Hot water 160°C** → After 3000 hours of use

The packing starts to swell

Accessory  
O-ring (2 pieces/set)  
Please apply grease at the replacement.

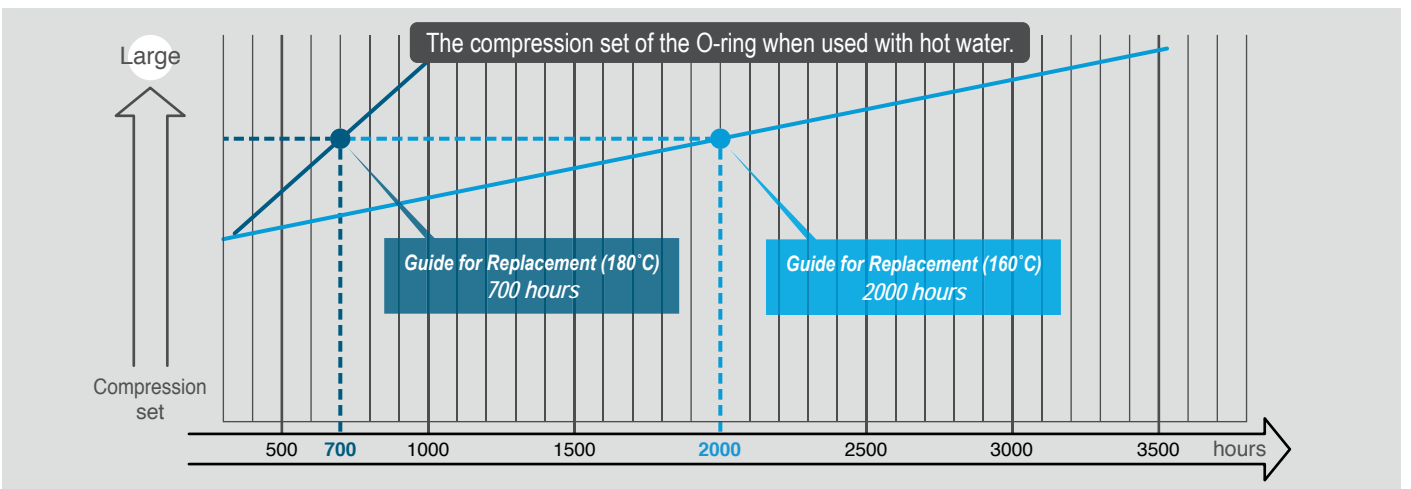

**Caution**

\*Hot water continuous flow test by a mold temperature controller

**Valve:** For continuous use of 3000 hours at 160°C / 1000 hours at 180°C

**O-ring:** For continuous use of 2000 hours at 160°C / 700 hours at 180°C

Although we have confirmed that there is no leakage, it is our experimental value and not a guaranteed value. Please consider above hours just as a guide. The durability of the seal differs depending on the customers usage conditions. (Number of connection / disconnection, fluid additives, etc.)

- Air will be admixed at the time of connection. Please purge the air by the equipment side when using with hot water.
- If additives are mixed in water or the piping is filled with steam, the lifetime of the seal will be decreased. When using in such an environment, conduct performance evaluation test by actual product.

For Medium Pressure

# ZEROSPILL CUPLA

Low spill type for medium pressure use

<b>Working pressure</b> 3.5 MPa {35 kgf/cm <sup>2</sup> }	<b>Valve structure</b> Two-way shut-off (Non-Spill)	<b>Applicable fluids</b>			
		Water	Hydraulic oil	Chemicals	Air
					Gas

Unique seal design reduces both liquid spillage and air ingress.

- New valve design offers smooth zero-friction movement.
- Push to connect design.
- The variety of body materials, sizes and end configurations has been standardized to comply with wide range of applications.
- Automatic shut-off valves in both socket and plug prevent fluid spill out on disconnection.



Specifications				
Body material	Brass		Stainless steel (SUS 304)	
Size (Thread)	1/4", 3/8", 1/2", 3/4", 1"			
Pressure unit	MPa	kgf/cm <sup>2</sup>	bar	PSI
Working pressure	3.5	36	36	508
Seal material Working temperature range	Seal material	Mark	Working temperature range	Remarks
	Nitrile rubber	NBR (SG)	-20°C to +80°C	Standard material
	Fluoro rubber	FKM (X-100)	-20°C to +180°C	Standard material
	Ethylene-propylene rubber	EPDM (EPT)	-40°C to +150°C	Standard material

Note: Applicable fluids depend on the body material and seal material.  
Acceptable working temperature range depends on operating conditions.

Maximum Tightening Torque		Nm {kgf·cm}				
Size (Thread)		1/4"	3/8"	1/2"	3/4"	1"
Torque	Brass	9 {92}	12 {122}	30 {306}	50 {510}	65 {663}
	Stainless steel	14 {143}	22 {224}	60 {612}	90 {918}	120 {1224}

**Flow Direction**

Fluid flow can be bi-directional when socket and plug are connected.

**Interchangeability**  
Socket and plug of different sizes cannot be connected.

Minimum Cross-Sectional Area (mm <sup>2</sup> )					
Model	ZEL-2SP	ZEL-3SP	ZEL-4SP	ZEL-6SP	ZEL-8SP
Min. cross-sectional area	31	60.5	86.5	160.6	188.7

Suitability for Vacuum 1.3 x 10 <sup>-1</sup> Pa {1 x 10 <sup>-3</sup> mmHg}		
Socket only	Plug only	When connected
—	—	Operational

Admixture of Air on Connection May vary depending upon the usage conditions. (mL)					
Model	ZEL-2SP	ZEL-3SP	ZEL-4SP	ZEL-6SP	ZEL-8SP
Volume of air admixture	0.16	0.21	0.37	1.12	1.52

Volume of Spillage per Disconnection May vary depending upon the usage conditions. (mL)					
Model	ZEL-2SP	ZEL-3SP	ZEL-4SP	ZEL-6SP	ZEL-8SP
Volume of spillage	0.06	0.12	0.20	0.43	0.55

\* Repeated connections and disconnections of CUPLA or the use of fluids with low viscosity may cause some spillage.

**Flow Rate – Pressure Loss Characteristics**

[Test conditions] • Fluid : Water • Temperature : 25°C to 27°C

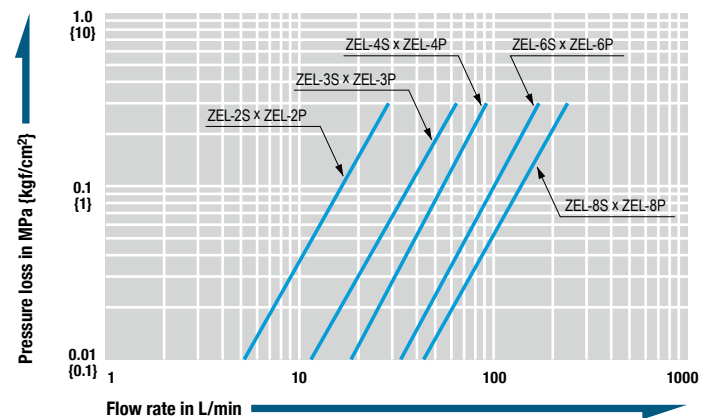

Models and Dimensions

**Plug Female thread**

Model	Application (Thread)	Mass (g)		Dimensions (mm)				
		Brass	Stainless steel	L	C	øD	H (WAF)	T
ZEL-2P	R 1/4	34	32	39	26.1	19	Hex.17	Rc 1/4
ZEL-3P	R 3/8	67	63	44.5	32	25	Hex.23	Rc 3/8
ZEL-4P	R 1/2	117	109	52.5	36.8	32	Hex.29	Rc 1/2
ZEL-6P	R 3/4	264	248	68.5	48	39.5	Hex.36	Rc 3/4
ZEL-8P	R 1	359	339	76.5	56	46	Hex.42	Rc 1

**Socket Female thread**

Model	Application (Thread)	Mass (g)		Dimensions (mm)			
		Brass	Stainless steel	L	øD	H (WAF)	T
ZEL-2S	R 1/4	133	125	(56)	28	Hex.21	Rc 1/4
ZEL-3S	R 3/8	255	239	(66)	35	Hex.27	Rc 3/8
ZEL-4S	R 1/2	404	382	(76)	42	Hex.32	Rc 1/2
ZEL-6S	R 3/4	829	784	(95.5)	55	Hex.42	Rc 3/4
ZEL-8S	R 1	1406	1326	(114.5)	65	Hex.50	Rc 1

\* The photos above show stainless steel model ZEL-8P and ZEL-8S. The profiles of brass couplings are the same as those of the stainless steel couplings.

# Main Features

## Unique seal design reduces both liquid spillage and air ingress

### To compare with SP CUPLA Type A.

**Volume of spillage:**  
about 96% less vs SP CUPLA Type A

**Volume of air ingress:**  
about 94% less vs SP CUPLA Type A

**SP CUPLA Type A**

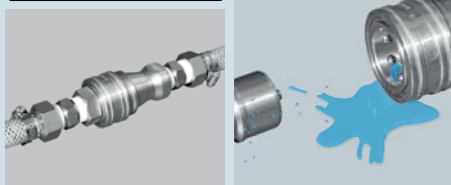

Connected

Disconnected

**ZEROSPILL CUPLA**

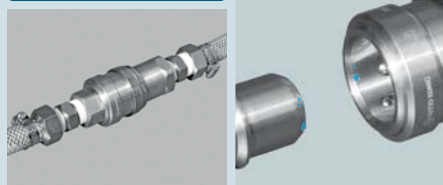

Connected

Disconnected



\*blue colored water is used to show volume of spillage clearly.

## Reliable zero friction valve

New valve design offers smooth zero-friction movement resulting in reduced chance of malfunction caused by deterioration of valve parts.

## Push-to-connect design One-hand easy operation

Just push the plug into the socket for simple and secure connection. This reduces connection time and improves efficiency.



Just push the plug into the socket

Simple and secure connection

### Accessory

## CUPLA ADAPTER for Braided Hose Connection

Can be screwed into CUPLA with female threads, 3/8", 1/2", 3/4"



See page 152 for the details.



Before use, please be sure to read "Safety Guide" described at the end of this book and "Instruction Sheet" that comes with the products.



For High Pressure

# HSP CUPLA

For hydraulic pressure from 14.0 to 20.6 MPa {142 to 210 kgf/cm<sup>2</sup>}

<p>Working pressure</p>  <p>14.0 to 20.6 MPa {14.0 to 210 kgf/cm<sup>2</sup>}</p>	<p>Valve structure</p>  <p>Two-way shut-off</p>	<p>Applicable fluid</p>  <p>Hydraulic oil</p>
---	--	--

Special steel body is tough against vibration and impact! Male and female thread end configurations are available. Low pressure loss characteristic suits hydraulic equipment applications.

- Quenched special steel body!  
Powerful impact resistance, especially against impulses.
- Automatic shut-off valves in both socket and plug prevent fluid spill out on disconnection.
- In addition to conventional female thread type, male thread types (male tapered thread, male parallel thread with 30° flare, and male parallel thread with 30° cone-seat) are available. Male thread types are designed especially for direct connection to hydraulic power units effectively.
- Male parallel thread type complies with both metal seal and O-ring seal. (In case of O-ring seal, O-rings available in the market can be used.)
- Optional HSP-DC CUPLA series are available for die-casting machine applications with severe pressure variation.
- The overall length of male thread type is shorter than that of female thread type plus conversion nipple available in the market.
- PL type (Safety sleeve lock type) for 2HS to 8HS (except 66HS) with female thread is also available as standard.

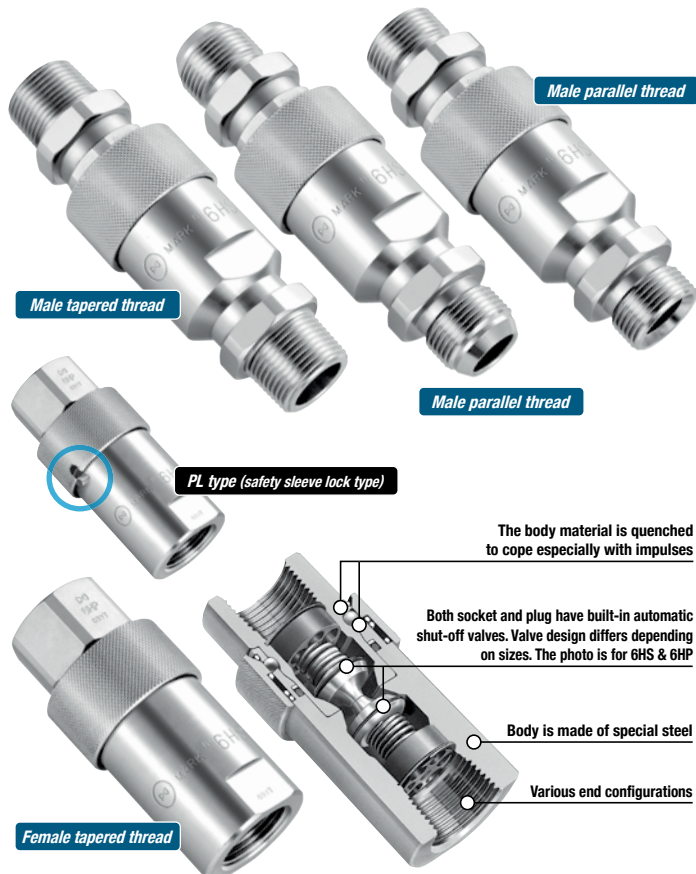

Specifications				
Body material	Special steel (Nickel plated)			
Size (Thread)	1/4", 3/8", 1/2", 3/4", 1"		1 1/4", 1 1/2" 2"	
Working pressure	MPa	20.6	18.0	14.0
	kgf/cm <sup>2</sup>	210	183	142
	bar	206	180	140
	PSI	2990	2610	2030
Seal material	Seal material	Mark	Working temperature range	Remarks
Working temperature range	Nitrile rubber	NBR (SG)	-20 °C to +80 °C	Standard material
	Fluoro rubber	FKM (X-100)	-20 °C to +180 °C	Available on request

Maximum Tightening Torque		Nm {kgf·cm}							
Size (Thread)		1/4"	3/8"	1/2"	3/4"	1"	1 1/4"	1 1/2"	2"
Torque	Female thread	28 {286}	45 {459}	90 {918}	100 {1020}	180 {1836}	290 {2958}	350 {3570}	500 {5100}
	Male taper thread	28 {286}	45 {459}	90 {918}	100 {1020}	—	—	—	—
	Parallel male thread	25 {255}	35 {357}	60 {612}	120 {1224}	—	—	—	—

**Flow Direction**

Fluid flow can be bi-directional when socket and plug are connected.

**Interchangeability**

4HSP with 6HSP or 10HSP with 12HSP can be connected with each other. Other combinations of different sizes are not connectable.

Minimum Cross-Sectional Area		(mm <sup>2</sup> )								
Model		2HSP	3HSP	4HSP	6HSP	66HSP	8HSP	10HSP	12HSP	16HSP
Minimum cross-sectional area		21	37	77	77	145	203	595	595	1084

Suitability for Vacuum		1.3 x 10 <sup>-1</sup> Pa {1 x 10 <sup>-3</sup> mmHg}		
	Socket only	Plug only	When connected	
	—	—	Operational	

Admixture of Air on Connection		May vary depending upon the usage conditions. (mL)								
Model		2HSP	3HSP	4HSP	6HSP	66HSP	8HSP	10HSP	12HSP	16HSP
Volume of air		0.7	1.9	3.5	3.5	8.2	12.4	44	44	156

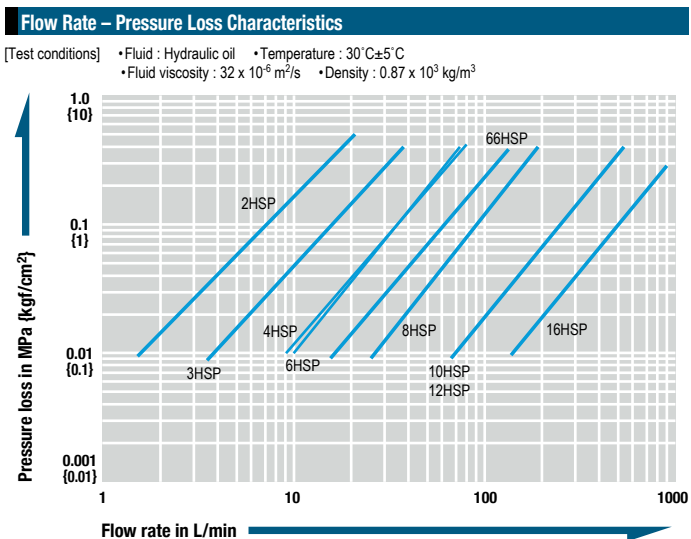

The flow volume of male thread type is increased by 5 to 10% compared with that of female thread type with conversion nipple.

**⚠ Precautions for use**

There is no interchangeability between HSP CUPLA and 210 CUPLA or 280 CUPLA. Do not connect to each other even if sizes are similar.

Models and Dimensions

Product appearance may vary by size. / WAF: WAF stands for width across flats.

**Plug HP type (Female tapered thread)**

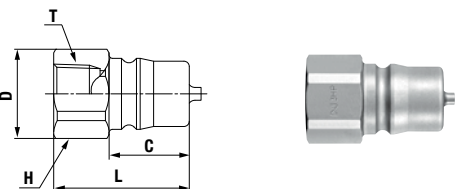

Model	Application (Thread)	Mass (g)	Dimensions (mm)				
			L	øD	C	H(WAF)	T
2HP	R 1/4	40	32	20.5	17.5	Hex.19	Rc 1/4
3HP	R 3/8	68	38	25	22.5	Hex.23	Rc 3/8
4HP	R 1/2	124	44	32	27.5	Hex.29	Rc 1/2
6HP	R 3/4	148	50	35	27.5	Hex.32	Rc 3/4
66HP	R 3/4	232	51	40	28	35	Rc 3/4
8HP	R 1	361	61	47	36	41	Rc 1
10HP	R 1 1/4	886	80	64	58	58	Rc 1 1/4
12HP	R 1 1/2	810	80	64	58	58	Rc 1 1/2
16HP	R 2	3,307	115	100	83	90	Rc 2

**Socket HS type (Female tapered thread)**

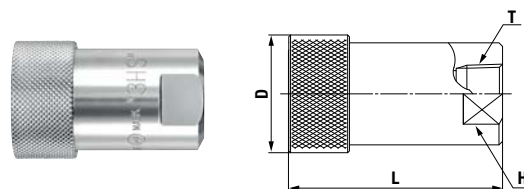

Model	Application (Thread)	Mass (g)	Dimensions (mm)			
			L	øD	H(WAF)	T
2HS	R 1/4	134	49	(27.5)	19	Rc 1/4
3HS	R 3/8	226	60	(33)	23	Rc 3/8
4HS	R 1/2	485	(72)	(43)	35	Rc 1/2
6HS	R 3/4	460	(72)	(43)	35	Rc 3/4
66HS	R 3/4	569	78.5	(47)	35	Rc 3/4
8HS	R 1	1,042	93	(58)	46	Rc 1
10HS	R 1 1/4	2,586	138	87	58	Rc 1 1/4
12HS	R 1 1/2	2,510	138	87	58	Rc 1 1/2
16HS	R 2	7,286	198	123	80	Rc 2

**Plug HP-R type (Male tapered thread)**

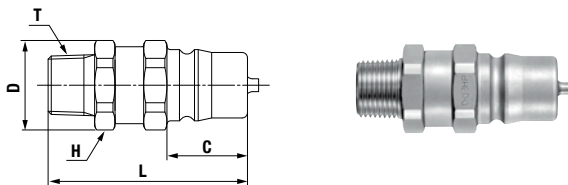

Model	Application (Thread)	Mass (g)	Dimensions (mm)				
			L	øD	C	H(WAF)	T
2HP-R	Rc 1/4	60	(49)	21	17.5	Hex.19	R 1/4
3HP-R	Rc 3/8	102	(55.5)	25	22.5	Hex.23	R 3/8
4HP-R	Rc 1/2	171	(63)	31	27.5	Hex.29	R 1/2
6HP-R	Rc 3/4	197	(66)	35	27.5	Hex.32	R 3/4

**Socket HS-R type (Male tapered thread)**

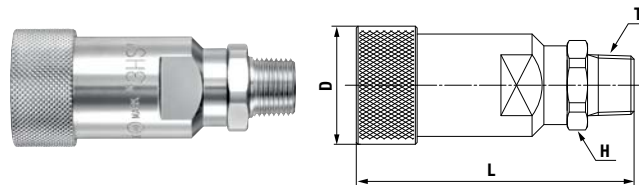

Model	Application (Thread)	Mass (g)	Dimensions (mm)			
			L	øD	H(WAF)	T
2HS-R	Rc 1/4	148	(66)	(27.5)	Hex.19	R 1/4
3HS-R	Rc 3/8	245	(77.5)	(33)	Hex.23	R 3/8
4HS-R	Rc 1/2	466	(90)	(43)	Hex.29	R 1/2
6HS-R	Rc 3/4	493	(93)	(43)	Hex.32	R 3/4

**Plug HP-GP type (Male parallel thread with 30° flare)**

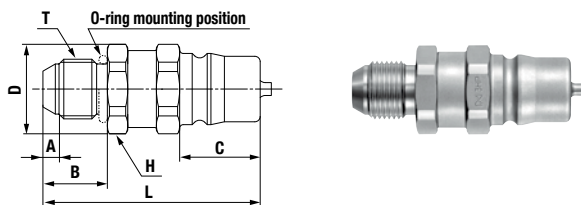

Model	Application* (Thread)	Mass (g)	O-ring size	Dimensions (mm)						
				L	øD	A	B	C	H(WAF)	T
2HP-GP	G 1/4	62	P-11	(52.5)	21	(4.5)	16	17.5	Hex.19	G 1/4B
3HP-GP	G 3/8	103	P-14	(60.5)	25	(4.5)	18	22.5	Hex.23	G 3/8B
4HP-GP	G 1/2	173	P-18	(66)	31	(5.5)	20	27.5	Hex.29	G 1/2B
6HP-GP	G 3/4	203	P-24	(69)	35	(5.5)	22	27.5	Hex.32	G 3/4B

**Socket HS-GP type (Male parallel thread with 30° flare)**

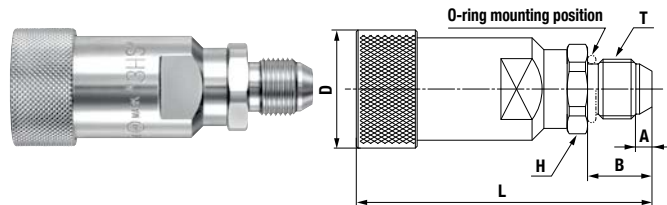

Model	Application* (Thread)	Mass (g)	O-ring size	Dimensions (mm)						
				L	øD	A	B	H(WAF)	T	
2HS-GP	G 1/4	149	P-11	(69.5)	(27.5)	(4.5)	16	Hex.19	G 1/4B	
3HS-GP	G 3/8	246	P-14	(82.5)	(33)	(4.5)	18	Hex.23	G 3/8B	
4HS-GP	G 1/2	476	P-18	(93)	(43)	(5.5)	20	Hex.29	G 1/2B	
6HS-GP	G 3/4	498	P-24	(96)	(43)	(5.5)	22	Hex.32	G 3/4B	

**Plug HP-GS type (Male parallel thread with 30° cone-seat)**

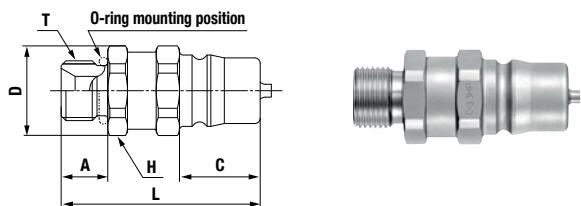

Model	Application* (Thread)	Mass (g)	O-ring size	Dimensions (mm)					
				L	øD	A	C	H(WAF)	T
2HP-GS	G 1/4	59	P-11	(48)	21	11.5	17.5	Hex.19	G 1/4B
3HP-GS	G 3/8	99	P-14	(55.5)	25	13	22.5	Hex.23	G 3/8B
4HP-GS	G 1/2	167	P-18	(60.5)	31	14.5	27.5	Hex.29	G 1/2B
6HP-GS	G 3/4	191	P-24	(63.5)	35	16.5	27.5	Hex.32	G 3/4B

**Socket HS-GS type (Male parallel thread with 30° cone-seat)**

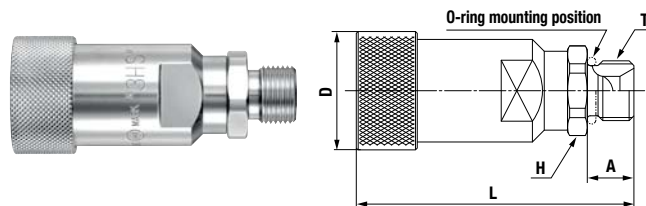

Model	Application* (Thread)	Mass (g)	O-ring size	Dimensions (mm)					
				L	øD	A	H(WAF)	T	
2HS-GS	G 1/4	146	P-11	(65)	(27.5)	11.5	Hex.19	G 1/4B	
3HS-GS	G 3/8	242	P-14	(77.5)	(33)	13	Hex.23	G 3/8B	
4HS-GS	G 1/2	469	P-18	(87.5)	(43)	14.5	Hex.29	G 1/2B	
6HS-GS	G 3/4	485	P-24	(90)	(43)	16.5	Hex.32	G 3/4B	

\*The counterpart of GP type must be the female parallel thread specified in JIS B 8363 with 30° cone-seat or the coupling with O-ring seal.

The counterpart of GS type must be the female parallel thread JIS B 8363 with 30° flare or the coupling with O-ring seal.

• Sleeve stopper design is available for models 2HS to 8HS (except 66HS).

For High Pressure

# HYPER HSP CUPLA

Connects hydraulic piping even with residual pressure up to 20.6 MPa {210 kgf/cm<sup>2</sup>}

Working pressure



Valve structure



Applicable fluid



Purge function will set you free from the troublesome residual pressure elimination before connection and let you achieve efficient and frequent hydraulic pipe line coupling.

- Both socket and plug have built-in automatic shut-off valves to prevent fluid spill out when disconnected.
- Interchangeable with standard HSP CUPLA plug or socket in the same size.

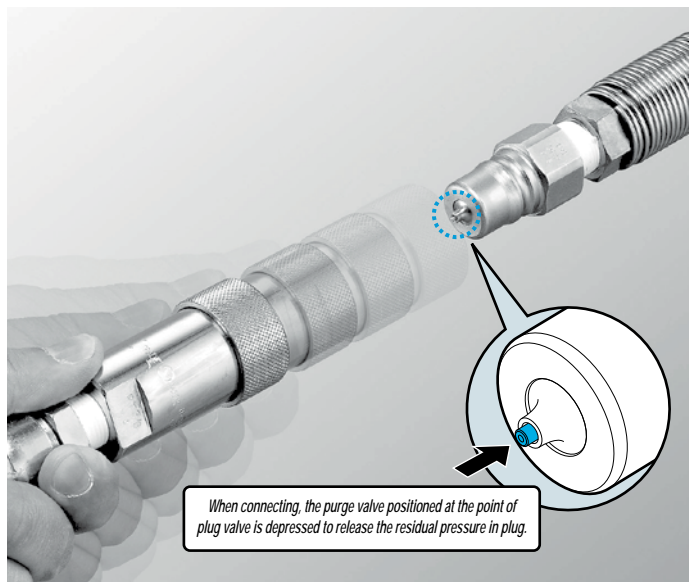

When connecting, the purge valve positioned at the point of plug valve is depressed to release the residual pressure in plug.

## Specifications

Body material	Special steel (Nickel plated)			
Size (Thread)	1/4", 3/8", 1/2", 3/4", 1"			
Pressure unit	MPa	kgf/cm <sup>2</sup>	bar	PSI
Working pressure	20.6	210	206	2990
Seal material	Seal material	Mark	Working temperature range	Remarks
Working temperature range	Nitrile rubber	NBR (SG)	-20°C to +80°C	Standard material

## Maximum Tightening Torque

Nm {kgf·cm}

Size (Thread)	1/4"	3/8"	1/2"	3/4"	1"
Torque	28 {286}	45 {459}	90 {918}	100 {1020}	180 {1836}

## Flow Direction

Fluid flow can be bi-directional when socket and plug are connected.



## Interchangeability

Interchangeable with standard HSP CUPLA plug or socket in the same size. Avoid connecting HYPER HSP CUPLA socket with HYPER HSP CUPLA plug. The residual pressure will not release.

## Minimum Cross-Sectional Area

(mm<sup>2</sup>)

Model	2HP-PV/2HS-PV	3HP-PV/3HS-PV	4HP-PV/4HS-PV	6HP-PV/6HS-PV	8HP-PV/8HS-PV
Minimum cross-sectional area	21	37	77	77	203

## Suitability for Vacuum

1.3 x 10<sup>-1</sup> Pa {1 x 10<sup>-3</sup> mmHg}

Socket only	Plug only	When connected
—	—	Operational

## Admixture of Air on Connection

May vary depending upon the usage conditions.

(mL)

Model	2HP-PV/2HS-PV	3HP-PV/3HS-PV	4HP-PV/4HS-PV	6HP-PV/6HS-PV	8HP-PV/8HS-PV
Volume of air	0.7	1.9	3.5	3.5	12.4

## Connection Load under Residual Pressure (For reference)

(N)

Residual pressure / Model	2HP-PV/2HS-PV	3HP-PV/3HS-PV	4HP-PV/4HS-PV	6HP-PV/6HS-PV	8HP-PV/8HS-PV
at 5.0 MPa	50	85	85	85	100
at 10.0 MPa	70	85	85	85	130
at 15.0 MPa	100	100	100	100	170

## Flow Rate – Pressure Loss Characteristics

[Test conditions] • Fluid : Hydraulic oil • Temperature : 30°C±5°C  
• Fluid viscosity : 32 x 10<sup>-6</sup> m<sup>2</sup>/s • Density : 0.87 x 10<sup>3</sup> kg/m<sup>3</sup>

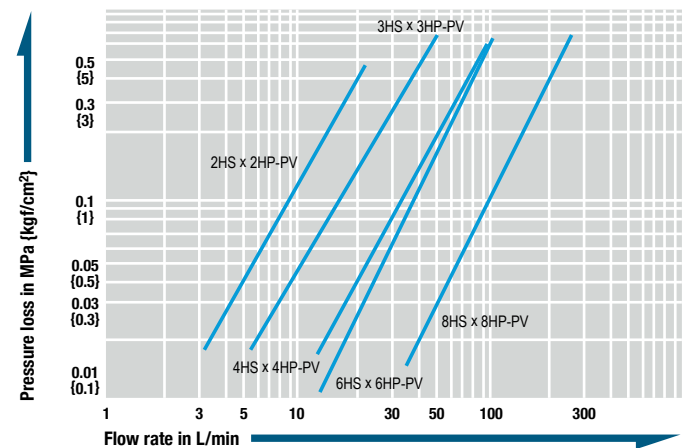

Note: Either socket or plug of HYPER HSP CUPLA must be used on the line where the residual pressure remains. The counterpart of HYPER HSP must be either plug or socket of standard HSP CUPLA.

Models and Dimensions

**Plug** HP type (Female thread)

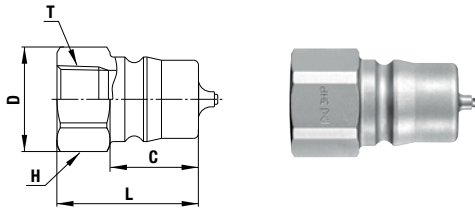

Model	Application (Thread)	Mass (g)	Dimensions (mm)				
			L	øD	C	H(WAF)	T
2HP-PV	R 1/4	44	32	20.5	17.5	Hex.19	Rc 1/4
3HP-PV	R 3/8	72	38	25	22.5	Hex.23	Rc 3/8
4HP-PV	R 1/2	138	44	32	27.5	Hex.29	Rc 1/2
6HP-PV	R 3/4	147	50	35	27.5	Hex.32	Rc 3/4
8HP-PV	R 1	360	61	47	36	41	Rc 1

**Socket** HS type (Female thread)

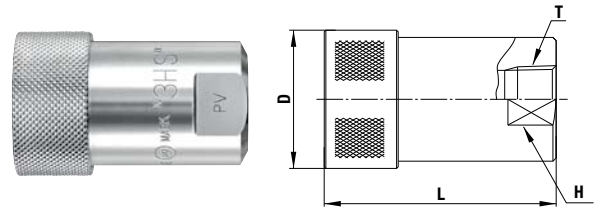

Model	Application (Thread)	Mass (g)	Dimensions (mm)			
			L	øD	H(WAF)	T
2HS-PV	R 1/4	136	49	(27.5)	19	Rc 1/4
3HS-PV	R 3/8	225	60	(33)	23	Rc 3/8
4HS-PV	R 1/2	485	(72)	(43)	35	Rc 1/2
6HS-PV	R 3/4	460	(72)	(43)	35	Rc 3/4
8HS-PV	R 1	1050	93	(58)	46	Rc 1

**Residual Pressure Release (or purge) Mechanism**

While connecting, the purge valve indicated with a circle is being pushed and releasing the residual pressure

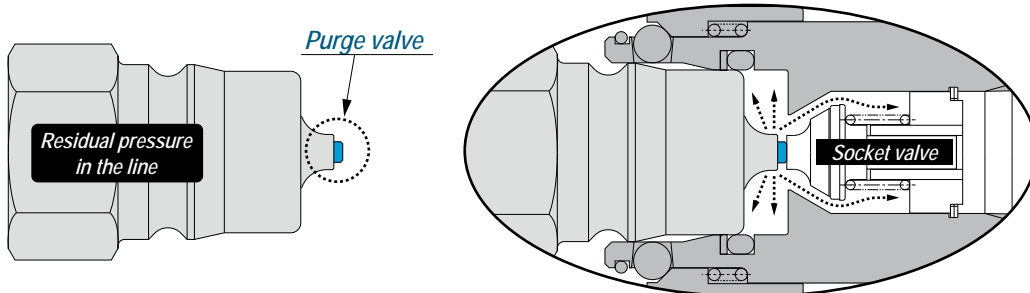



**Note:** Either socket or plug of HYPER HSP CUPLA must be used on the line where the residual pressure remains. The counterpart of HYPER HSP must be either plug or socket of standard HSP CUPLA. HYPER HSP CUPLA can be connected under the residual pressure in the line, but cannot during pressurizing. It may lead to incomplete connection, durability deterioration or possible valve fly out.



For High Pressure

# 210 CUPLA

For hydraulic pressure up to 20.6 MPa {210 kgf/cm<sup>2</sup>}

Working pressure	Valve structure	Applicable fluid
 20.6 MPa {210 kgf/cm <sup>2</sup> }	 Two-way shut-off	 Hydraulic oil

Standard hydraulic CUPLA for general purposes with a working pressure up to 20.6 MPa.

Low pressure loss, suitable for hydraulic equipment.

- General purpose hydraulic CUPLA with a working pressure of 20.6 MPa {210 kgf/cm<sup>2</sup>}.
- Structure is designed to reduce pressure loss to the lowest, and is best for hydraulic applications that need big flow rates.
- Both socket and plug have built-in automatic shut-off valves that prevent fluid outflow when disconnected.

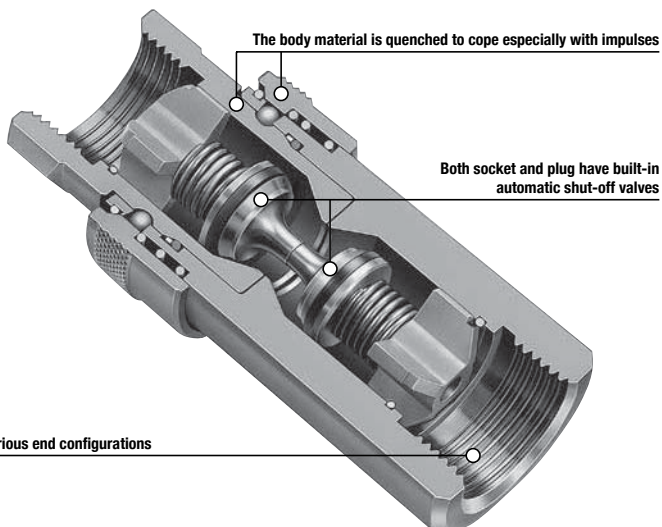

Various end configurations

Specifications				
Body material	Special steel (Nickel plated)			
Size (Thread)	1/4", 3/8", 1/2", 3/4", 1"			
Pressure unit	MPa	kgf/cm <sup>2</sup>	bar	PSI
Working pressure	20.6	210	206	2990
Seal material Working temperature range	Seal material	Mark	Working temperature range	Remarks
	Nitrile rubber	NBR (SG)	-20°C to +80°C	Standard material
	Fluoro rubber	FKM (X-100)	-20°C to +180°C	Available on request

Maximum Tightening Torque		Nm {kgf·cm}				
Size (Thread)		1/4"	3/8"	1/2"	3/4"	1"
Torque		28 {286}	45 {459}	90 {918}	100 {1020}	180 {1836}

**Flow Direction**

Fluid flow can be bi-directional when socket and plug are connected.

**Interchangeability**

Socket and plug of different sizes cannot be connected.

Minimum Cross-Sectional Area		(mm <sup>2</sup> )				
Model		210-2SP	210-3SP	210-4SP	210-6SP	210-8SP
Minimum cross-sectional area		24.5	42.8	77.4	146.5	235.6

Suitability for Vacuum		1.3 Pa {1 x 10 <sup>-2</sup> mmHg}	
Socket only	Plug only	When connected	
—	—	Operational	

Admixture of Air on Connection		May vary depending upon the usage conditions. (mL)				
Model		210-2SP	210-3SP	210-4SP	210-6SP	210-8SP
Volume of air		0.85	1.02	2.63	8.83	16.04

**Flow Rate – Pressure Loss Characteristics**

[Test conditions] • Fluid : Hydraulic oil • Temperature : 30°C±5°C  
 • Fluid viscosity : 32 x 10<sup>-6</sup> m<sup>2</sup>/s • Density : 0.87 x 10<sup>3</sup> kg/m<sup>3</sup>

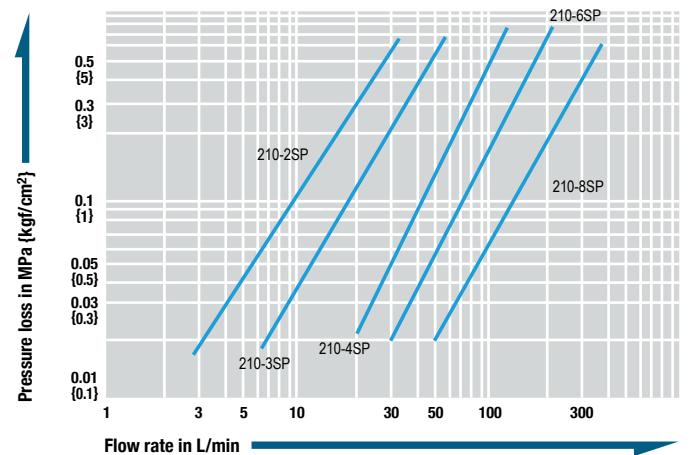

**⚠ Precautions for use**

There is no interchangeability between 210 CUPLA and HSP CUPLA or 280 CUPLA. Do not connect each other even if some sizes are approximate.

**Plug Female thread**

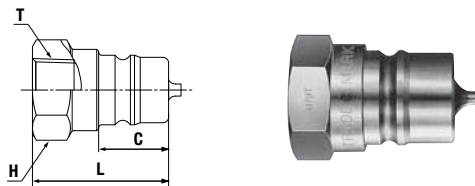

Model	Application (Thread)	Mass (g)	Dimensions (mm)			
			L	C	H(WAF)	T
210-2P	R 1/4	39	33	18	Hex.19	Rc 1/4
210-3P	R 3/8	57	36	18.5	Hex.23	Rc 3/8
210-4P	R 1/2	90	42.5	24	Hex.27	Rc 1/2
210-6P	R 3/4	195	51	28	Hex.35	Rc 3/4
210-8P	R 1	293	61	35	Hex.41	Rc 1

**Socket Female thread**

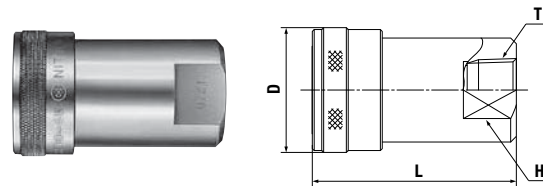

Model	Application (Thread)	Mass (g)	Dimensions (mm)			
			L	øD	H(WAF)	T
210-2S	R 1/4	158	50.5	(30)	22	Rc 1/4
210-3S	R 3/8	193	54	(33)	23	Rc 3/8
210-4S	R 1/2	330	65	(39)	29	Rc 1/2
210-6S	R 3/4	566	78.5	(48)	35	Rc 3/4
210-8S	R 1	861	95	(55)	41	Rc 1

**Application Example**

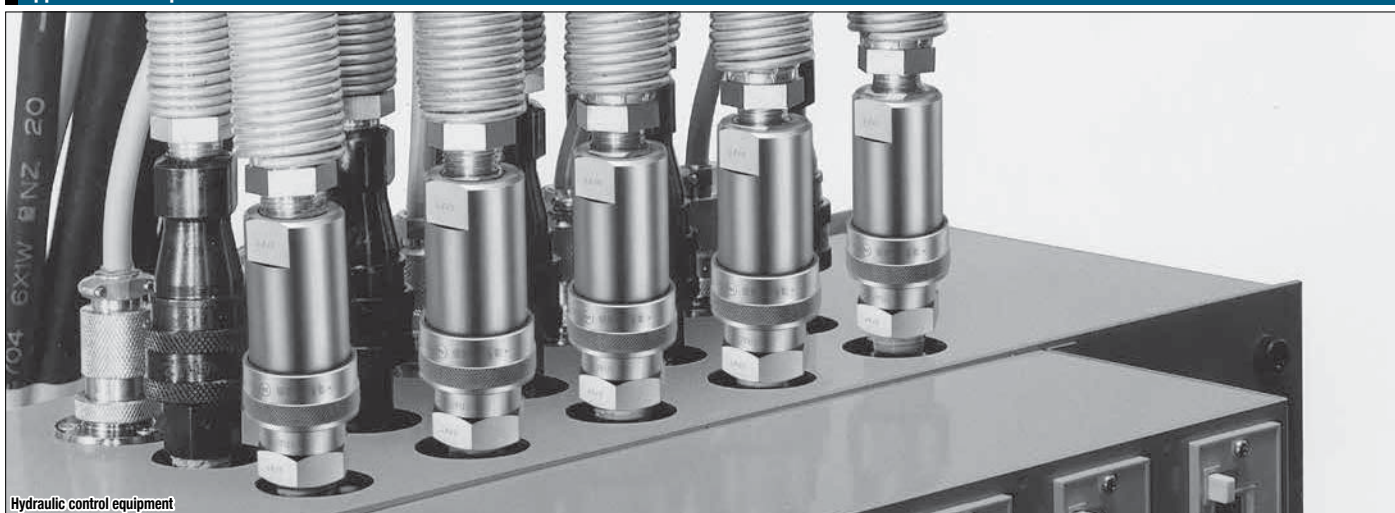

Hydraulic control equipment



Construction machinery

For High Pressure

# HSU CUPLA

Stainless steel CUPLA for high pressure up to 21.0 MPa {214 kgf/cm<sup>2</sup>}

<b>Working pressure</b>  21.0 MPa {214 kgf/cm <sup>2</sup> }	<b>Valve structure</b>  Two-way shut-off	<b>Applicable fluids</b>  Water    Hydraulic oil    Gas
---	--	---

The flow volume is increased by between 14 to 44% while at the same time the coupled length is reduced by at least 10% compared with the S210 CUPLA.

- Body material is excellent corrosion resistant stainless steel (SUS304). Suitable for use in tough / harsh environments such as offshore applications.
- Sleeve stopper mechanism can be engaged by rotating sleeve after connection.
- Despite having a stainless steel body, the working pressure, 21.0 MPa, of HSU CUPLA is comparable to that of special steel body CUPLA such as HSP CUPLA series.
- Both socket and plug have built-in automatic shut-off valves that prevent fluid outflow on disconnection.
- Hydrogenated nitrile rubber (HNBR) is used as a seal material for wide variety of liquids.



Specifications				
Body material	Stainless steel (SUS304)			
Size (Thread)	1/4", 3/8", 1/2", 3/4", 1"			
Pressure unit	MPa	kgf/cm <sup>2</sup>	bar	PSI
Working pressure	21.0	214	210	3050
Seal material	Seal material	Mark	Working temperature range	
Working temperature range	Hydrogenated nitrile rubber*	HNBR	-20°C to +120°C	

\* The seal materials used in HSU CUPLA are not suitable for Freon gas.

Maximum Tightening Torque		Nm {kgf·cm}				
Size (Thread)		1/4"	3/8"	1/2"	3/4"	1"
Torque		28 {286}	35 {357}	70 {714}	100 {1020}	180 {1836}

**Flow Direction**

Fluid flow can be bi-directional when socket and plug are connected.

**Interchangeability**  
Socket and plug of different sizes cannot be connected.

Minimum Cross-Sectional Area		(mm <sup>2</sup> )				
Model		HSU-2SP	HSU-3SP	HSU-4SP	HSU-6SP	HSU-8SP
Minimum cross-sectional area		27.1	48.2	84.2	143.6	221.2

Suitability for Vacuum		1.3 × 10 <sup>-1</sup> Pa {1 × 10 <sup>-3</sup> mmHg}		
	Socket only	Plug only	When connected	
	—	—	Operational	

Admixture of Air on Connection		May vary depending upon the usage conditions. (mL)				
Model		HSU-2SP	HSU-3SP	HSU-4SP	HSU-6SP	HSU-8SP
Volume of air admixture		0.7	1.5	3.6	6.3	10.9

Volume of Spillage per Disconnection		May vary depending upon the usage conditions. (mL)				
Model		HSU-2SP	HSU-3SP	HSU-4SP	HSU-6SP	HSU-8SP
Volume of spillage		0.6	1.7	3.0	6.8	11.2

**Flow Rate – Pressure Loss Characteristics (Hydraulic oil / Water)**

[Test conditions] • Fluid : Hydraulic oil • Temperature : 30°C to 32°C  
• Fluid viscosity : 32 × 10<sup>-6</sup> m<sup>2</sup>/s • Density : 0.87 × 10<sup>3</sup> kg/m<sup>3</sup>

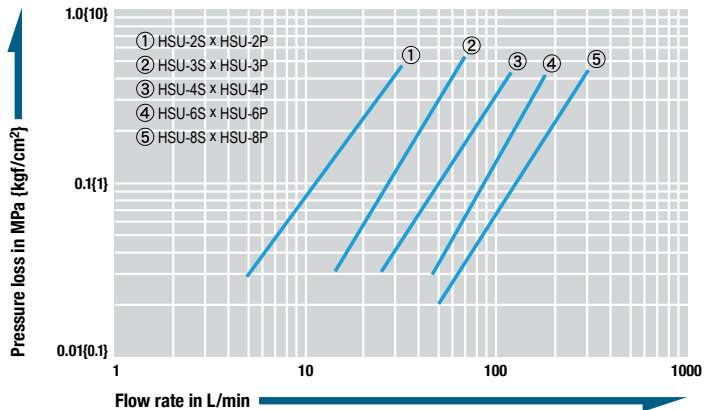

[Test conditions] • Fluid : Water • Temperature : 18°C

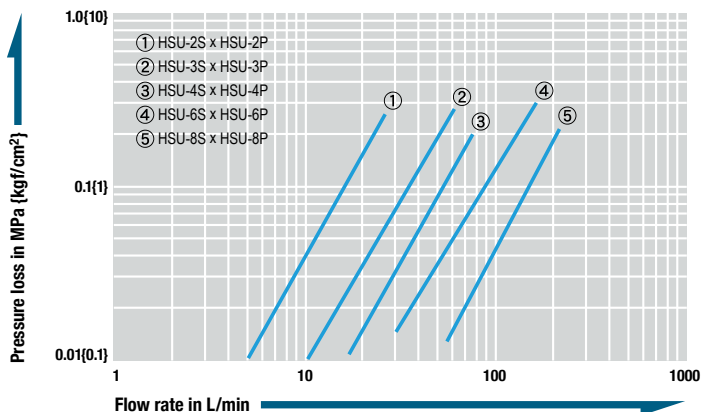



Models and Dimensions

**Plug Female thread**

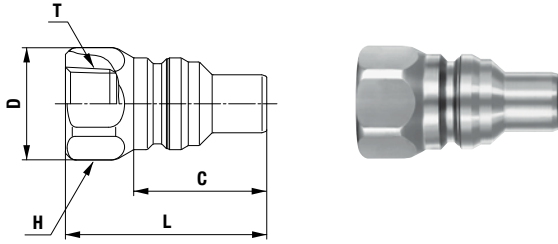

Model	Application (Thread)	Mass (g)	Dimensions (mm)				
			L	C	øD	H (WAF)	T
HSU-2P	R 1/4	49	45.5	27.5	21	Hex.19	Rc 1/4
HSU-3P	R 3/8	86	51.5	32	26.5	Hex.24	Rc 3/8
HSU-4P	R 1/2	152	59	39	33	Hex.30	Rc 1/2
HSU-6P	R 3/4	295	74	51.5	42	Hex.38	Rc 3/4
HSU-8P	R 1	481	83	58	51	Hex.46	Rc 1

**Socket Female thread**

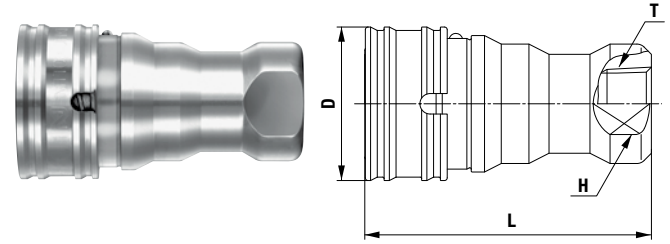

Model	Application (Thread)	Mass (g)	Dimensions (mm)			
			L	øD	H (WAF)	T
HSU-2S	R 1/4	142	63	28	19	Rc 1/4
HSU-3S	R 3/8	255	71.5	35	24	Rc 3/8
HSU-4S	R 1/2	479	84	45	30	Rc 1/2
HSU-6S	R 3/4	953	106	55	38	Rc 3/4
HSU-8S	R 1	1432	118	65	46	Rc 1

Sleeve Stopper Mechanism

*Easy to operate sleeve stopper mechanism enhances operator safety.*

**At connection**

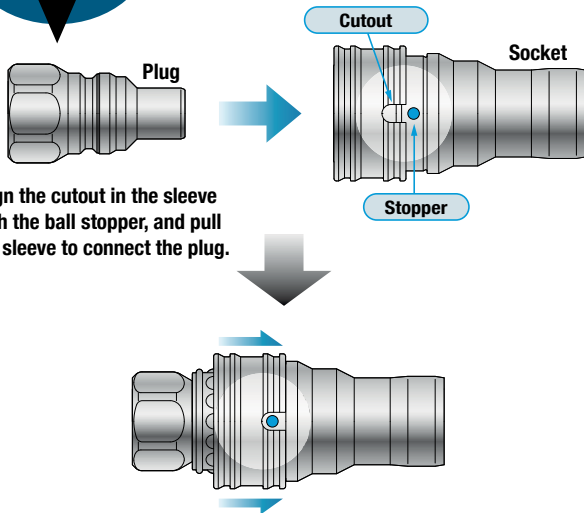

Align the cutout in the sleeve with the ball stopper, and pull the sleeve to connect the plug.

**Locking the sleeve**

Without alignment of the cutout with the ball stopper disconnection cannot be made.

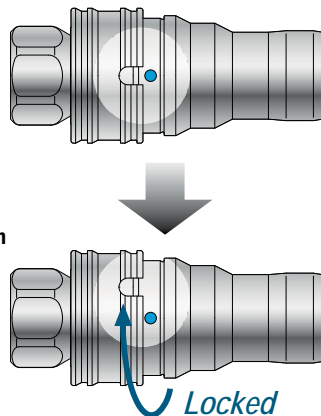

Sleeve stopper mechanism can be engaged by rotating sleeve after connection.

*Accidental disconnection is prevented.*





The stopper is marked with blue for visual understanding.



For High Pressure

# S210 CUPLA

Stainless steel CUPLA for high pressure up to 20.6 MPa {210 kgf/cm<sup>2</sup>}

<b>Working pressure</b>	<b>Valve structure</b>	<b>Applicable fluids</b>		
 20.6 MPa (210 kgf/cm <sup>2</sup> )	 Two-way shut-off			
		Water	Hydraulic oil	Gas

Stainless steel for excellent corrosion resistance!  
The unique “inner seal mechanism” accepts a working pressure up to 20.6 MPa.

- Body material is excellent corrosion resistant stainless steel (SUS304). Suited for use in tough conditions such as ocean development.
- Although it is made of stainless steel, the unique “inner seal mechanism” enables the working pressure of 20.6 MPa {210 kgf/cm<sup>2</sup>}, the same as special steel's.
- Safety lock (accidental disconnection prevention mechanism) ensures tight and secured connection under vibration or impacts.
- Both socket and plug have built-in automatic shut-off valves that prevent fluid outflow on disconnection.

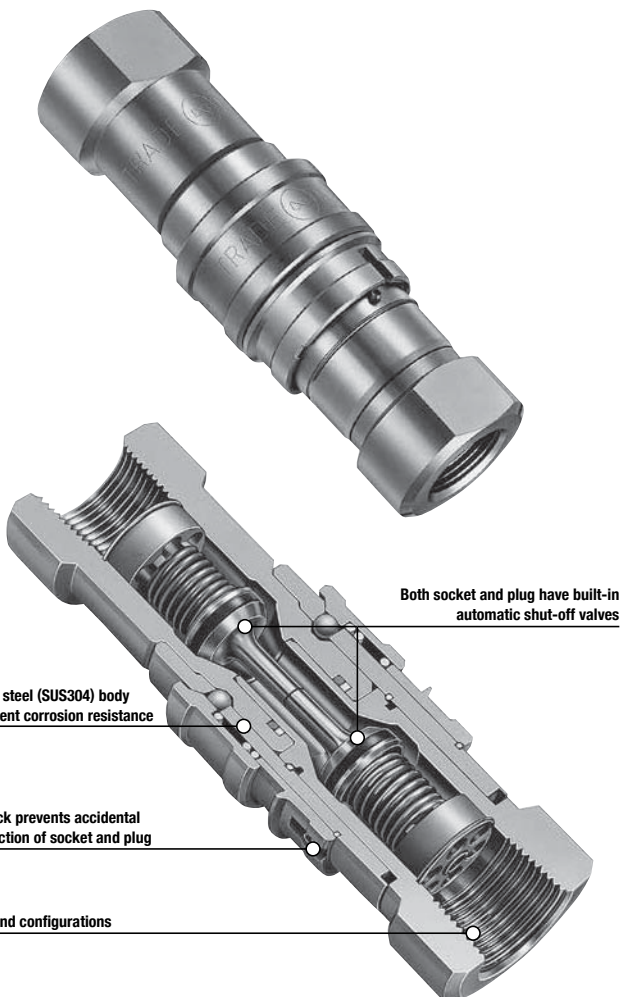

Specifications				
Body material	Stainless steel (SUS304)			
Size (Thread)	1/4", 3/8", 1/2", 3/4", 1"			
Pressure unit	MPa	kgf/cm <sup>2</sup>	bar	PSI
Working pressure	20.6	210	206	2990
Seal material Working temperature range	Seal material	Mark	Working temperature range	Remarks
	Fluoro rubber	FKM (X-100)	-20°C to +180°C	Standard material
	Nitrile rubber	NBR (SG)	-20°C to +80°C	Made-to-order item

\* The product comes with a dust cap.

Maximum Tightening Torque		Nm {kgf·cm}				
Size (Thread)		1/4"	3/8"	1/2"	3/4"	1"
Torque		28 {286}	35 {357}	70 {714}	100 {1020}	180 {1836}

**Flow Direction**

Fluid flow can be bi-directional when socket and plug are connected.

**Interchangeability**

Socket and plug of different sizes cannot be connected.

Minimum Cross-Sectional Area		(mm <sup>2</sup> )				
Model		S210-2SP	S210-3SP	S210-4SP	S210-6SP	S210-8SP
Minimum cross-sectional area		24	47	84	153	233

Suitability for Vacuum		1.3 Pa {1 x 10 <sup>-2</sup> mmHg}	
Socket only		Plug only	When connected
—		—	Operational

Admixture of Air on Connection		May vary depending upon the usage conditions. (mL)				
Model		S210-2SP	S210-3SP	S210-4SP	S210-6SP	S210-8SP
Volume of air		0.8	1.6	3.2	6.3	14.3

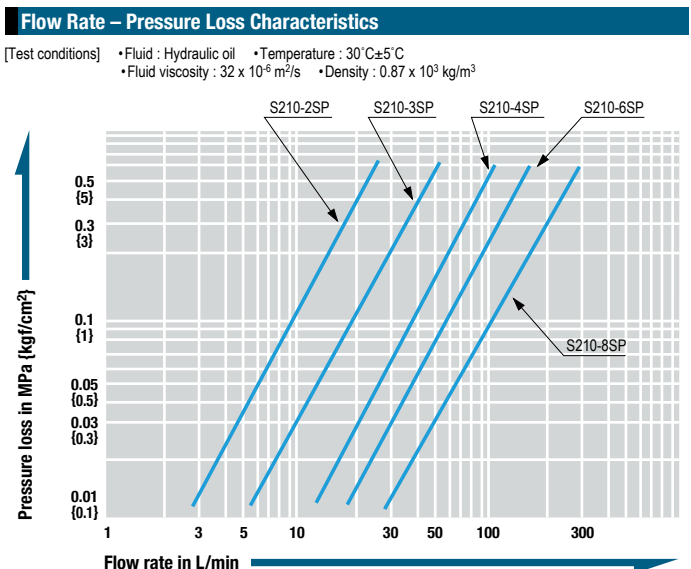

**Plug Female thread**

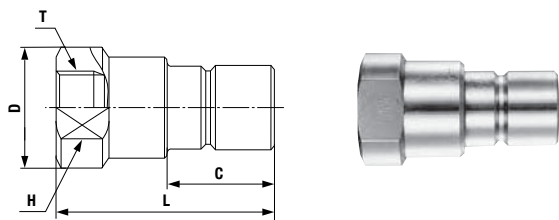

Model	Application (Thread)	Mass (g)	Dimensions (mm)				
			L	C	øD	H(WAF)	T
S210-2P	R 1/4	74	50.5	20	22	19	Rc 1/4
S210-3P	R 3/8	127	59	24	28	24	Rc 3/8
S210-4P	R 1/2	239	70.5	28	35	30	Rc 1/2
S210-6P	R 3/4	446	81.5	35.5	44	38	Rc 3/4
S210-8P	R 1	939	100	47.5	58	50	Rc 1

**Socket Female thread**

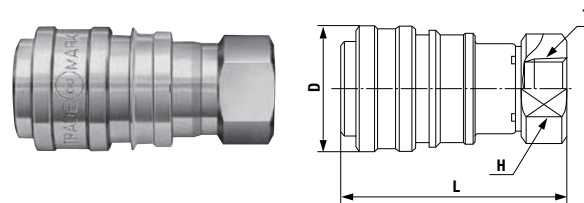

Model	Application (Thread)	Mass (g)	Dimensions (mm)			
			L	øD	H(WAF)	T
S210-2S	R 1/4	137	(59)	27	19	Rc 1/4
S210-3S	R 3/8	226	(68.5)	32	24	Rc 3/8
S210-4S	R 1/2	406	(81)	39.7	30	Rc 1/2
S210-6S	R 3/4	710	(97.5)	48	38	Rc 3/4
S210-8S	R 1	1381	(118)	62	50	Rc 1

**How to operate the Safety Lock**

**How to lock**

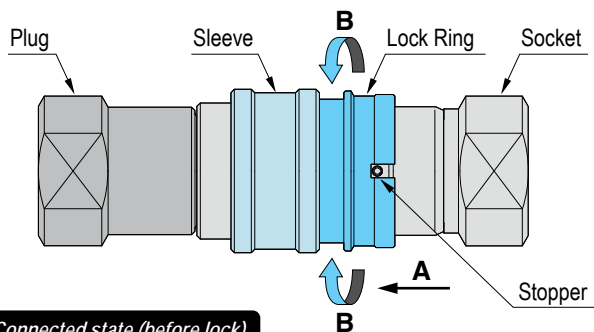

Connected state (before lock)

Slide the Lock Ring in the direction of the arrow A and rotate it in either direction simultaneously. When the Stopper is aligned with the shallow cutout on the Lock Ring, the CUPLA will be locked.

**How to unlock**

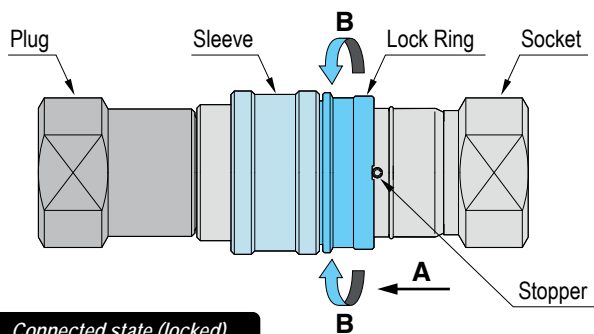

Connected state (locked)

Slide the Lock Ring in the direction of the arrow A and rotate it in either direction simultaneously. When the Stopper is aligned with the deeper cutout on the Lock Ring, the CUPLA will be unlocked.

**Application Example**

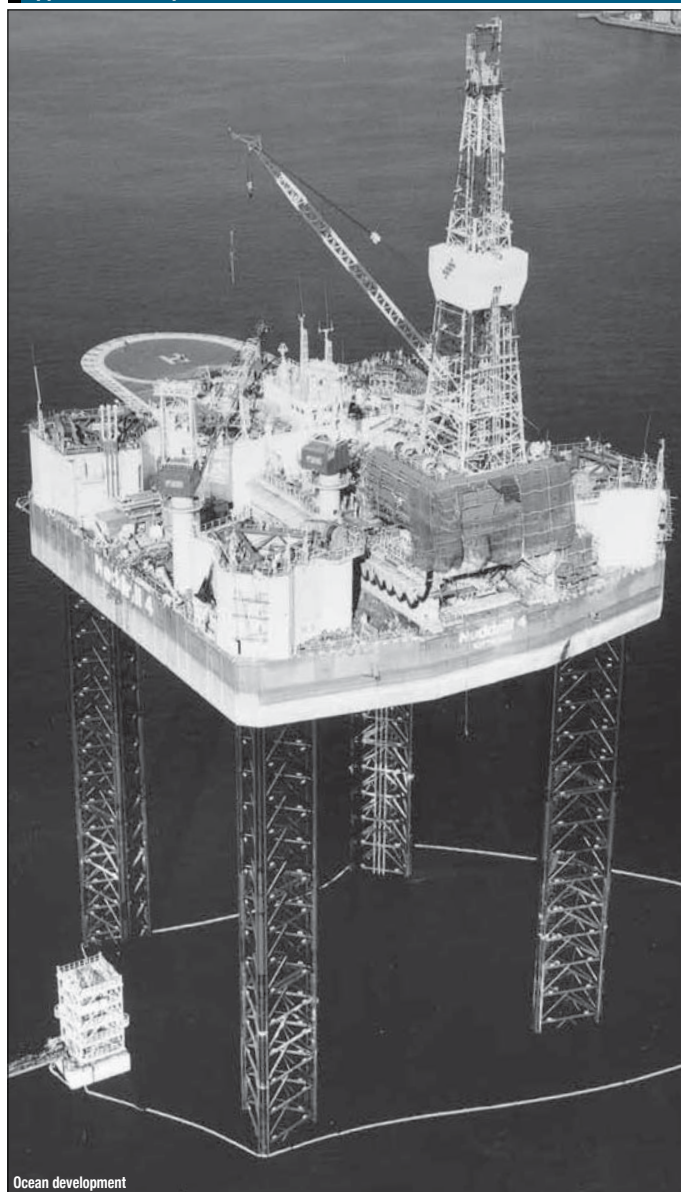

Ocean development

For High Pressure

# 280 CUPLA

For hydraulic pressure up to 27.5 to 31.5 MPa {281 to 321 kgf/cm<sup>2</sup>}

Working pressure



27.5 to 31.5 MPa  
(281 to 321 kgf/cm<sup>2</sup>)

Valve structure



Two-way shut-off

Applicable fluid



Hydraulic oil

**Generic CUPLA copes with high pressure lines in hydraulic equipment! Low pressure loss is ideal for hydraulic equipment.**

- Conforms to international standard ISO 7241-1A.
- General purpose hydraulic CUPLA with the working pressure up to 27.5 to 31.5 MPa {281 to 321 kgf/cm<sup>2</sup>}.
- Structure keeps pressure loss extremely low, particularly ideal for hydraulic applications requiring high flow rates.
- Both socket and plug have built-in automatic shut-off valves to prevent fluid spill out when disconnected.
- Special steel body material is adopted for its excellent strength and additional quenching treatment is done to withstand hydro pressure impacts.



Specifications				
Body material	Special steel (Bright chromate conversion coating : silver color)			
Size (Thread)	1/4", 3/8"		1/2", 3/4", 1"	
Working pressure	MPa	31.5	27.5	
	kgf/cm <sup>2</sup>	321	281	
	bar	315	275	
	PSI	4570	3990	
Seal material	Nitrile rubber	Mark	NBR (SG)	Working temperature range -20 °C to +80 °C Remarks Standard material
Working temperature range				

Maximum Tightening Torque		Nm {kgf·cm}				
Size (Thread)		1/4"	3/8"	1/2"	3/4"	1"
Torque		28 {286}	40 {408}	80 {816}	100 {1020}	180 {1836}

**Flow Direction**

Fluid flow can be bi-directional when socket and plug are connected.

**Interchangeability**

Socket and plug of different sizes cannot be connected. Can be connected with products whose mating part dimensions are in compliance with ISO7241-1A.

Minimum Cross-Sectional Area	(mm <sup>2</sup> )				
Model	280-2SP	280-3SP	280-4SP	280-6SP	280-8SP
Minimum cross-sectional area	11.4	42.8	79.1	146.5	235.6

Suitability for Vacuum		1.3 Pa {1 x 10 <sup>-2</sup> mmHg}
Socket only	Plug only	When connected
—	—	Operational

Admixture of Air on Connection		May vary depending upon the usage conditions. (mL)				
Model	280-2SP	280-3SP	280-4SP	280-6SP	280-8SP	
Volume of air	0.37	1.02	2.63	8.83	16.04	

**Flow Rate – Pressure Loss Characteristics**

[Test conditions] • Fluid : Hydraulic oil • Temperature : 30 °C±5 °C  
• Fluid viscosity : 32 x 10<sup>-6</sup> m<sup>2</sup>/s • Density : 0.87 x 10<sup>3</sup> kg/m<sup>3</sup>

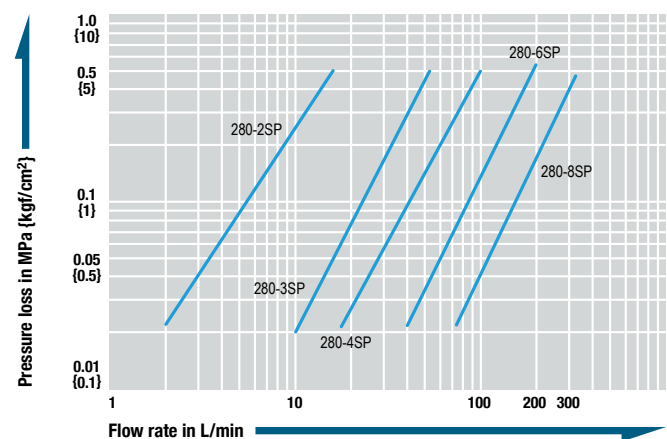

**⚠ Precautions for use**

There is no interchangeability between 280 CUPLA and HSP CUPLA or 210 CUPLA. Do not connect each other even if some sizes are approximate.



Models and Dimensions

**Plug Female thread**

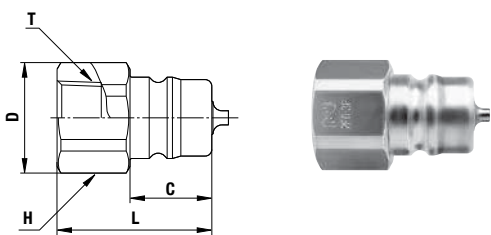

Model	Application (Thread)	Mass (g)	Dimensions (mm)				
			L	øD	C	H(WAF)	T
280-2P	R 1/4	35	31.5	20.5	15	Hex.19	Rc 1/4
280-3P	R 3/8	59	35	25	18.5	Hex.23	Rc 3/8
280-4P	R 1/2	115	44	32	24.5	Hex.29	Rc 1/2
280-6P	R 3/4	178	52.5	35	28	Hex.32	Rc 3/4
280-8P	R 1	331	63.5	44	35	41	Rc 1

\* Internal structural design of 280-6S and 280-8S is partly different from the above drawing.

**Socket Female thread**

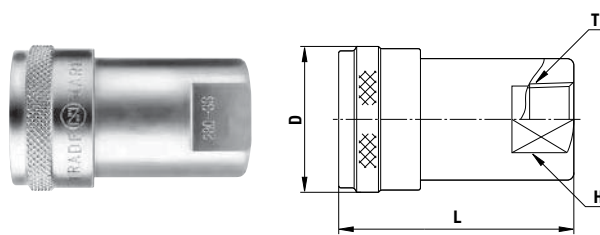

Model	Application (Thread)	Mass (g)	Dimensions (mm)			
			L	øD	H(WAF)	T
280-2S	R 1/4	110	(46)	(27)	19	Rc 1/4
280-3S	R 3/8	185	(53)	(33)	23	Rc 3/8
280-4S	R 1/2	335	66.5	(39)	29	Rc 1/2
280-6S	R 3/4	571	(81)	(48)	35	Rc 3/4
280-8S	R 1	871	98	(55)	41	Rc 1

**Application Example**

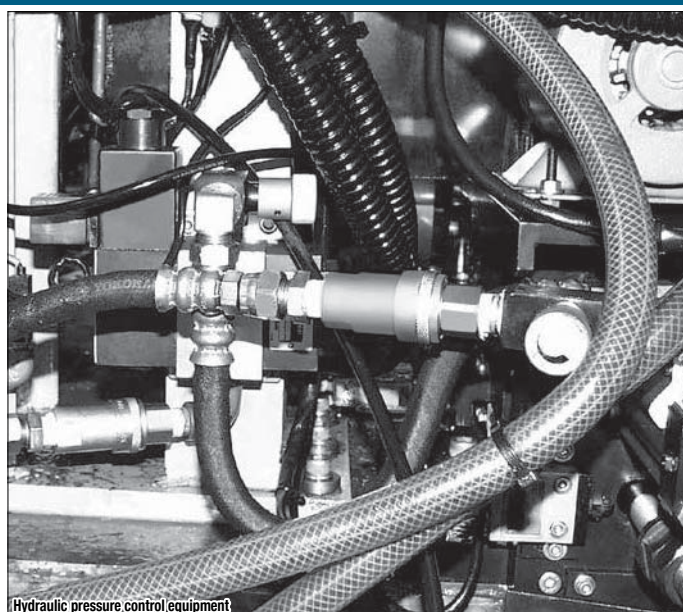
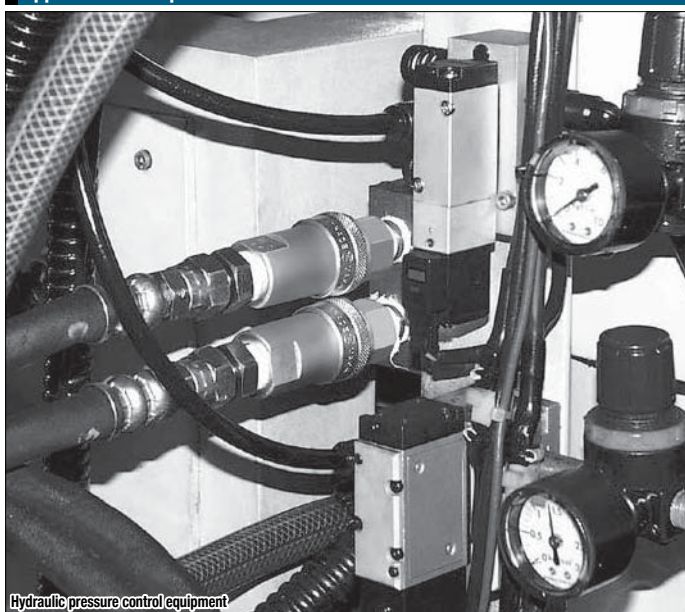



For High Pressure

# 350 CUPLA

For hydraulic pressures up to 34.5 MPa {352 kgf/cm<sup>2</sup>}

Working pressure

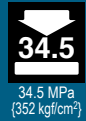

Valve structure



Applicable fluid



Their “airless valve shut-off design” greatly reduces air admixture! Ideal for hydraulic lines with larger pressure fluctuations.

- Sleeve stopper mechanism can be engaged by rotating sleeve after connection.
- Both socket and plug have built-in automatic shut-off valves to prevent fluid spill out when disconnected.

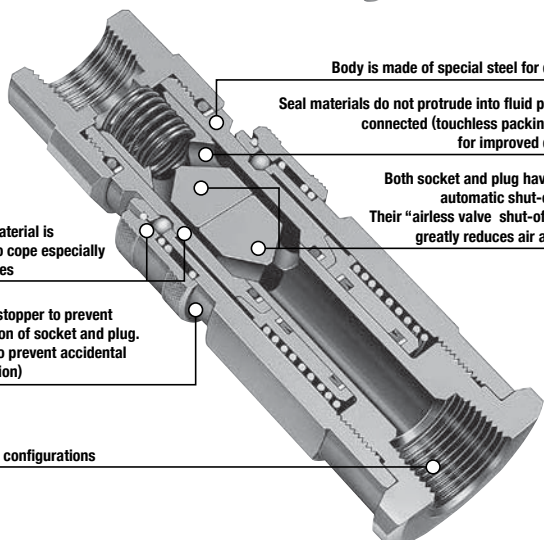

Body is made of special steel for durability

Seal materials do not protrude into fluid path when connected (touchless packing design) for improved durability

Both socket and plug have built-in automatic shut-off valves Their “airless valve shut-off design” greatly reduces air admixture

The body material is quenched to cope especially with impulses

Fitted with stopper to prevent disconnection of socket and plug. (Designed to prevent accidental disconnection)

Various end configurations

## Specifications

Body material	Special steel (Nickel plated)			
Size (Thread)	1/4", 3/8", 1/2", 3/4", 1", 1 1/4", 1 1/2"			
Pressure unit	MPa	kgf/cm <sup>2</sup>	bar	PSI
Working pressure	34.5	352	345	5000
Seal material	Seal material	Mark	Working temperature range	Remarks
Working temperature range	Fluoro rubber	FKM (X-100)	-20°C to +180°C	Standard material

## Maximum Tightening Torque

Nm {kgf·cm}

Size (Thread)	1/4"	3/8"	1/2"	3/4"	1"	1 1/4"	1 1/2"
Torque	28 {286}	40 {408}	80 {816}	150 {1530}	250 {2550}	500 {5100}	500 {5100}

## Flow Direction

Fluid flow can be bi-directional when socket and plug are connected.



## Interchangeability

Socket and plug of different sizes cannot be connected. However, 350-2SP with 350-3SP or 350-10SP with 350-12SP can be connected with each other.

## Minimum Cross-Sectional Area

(mm<sup>2</sup>)

Model	350-2SP	350-3SP	350-4SP	350-6SP	350-8SP	350-10SP	350-12SP
Minimum cross-sectional area	34.2	34.2	73.0	149.6	227.0	452.4	452.4

## Suitability for Vacuum

Not suitable for vacuum application in either connected or disconnected condition.

## Admixture of Air on Connection

May vary depending upon the usage conditions.

(mL)

Model	350-2SP	350-3SP	350-4SP	350-6SP	350-8SP	350-10SP	350-12SP
Volume of air	0.1	0.1	0.2	0.3	0.5	0.9	0.9

## Flow Rate – Pressure Loss Characteristics

[Test conditions] • Fluid : Hydraulic oil • Temperature : 40°C±5°C  
• Fluid viscosity : 32 x 10<sup>-6</sup> m<sup>2</sup>/s • Density : 0.87 x 10<sup>3</sup> kg/m<sup>3</sup>

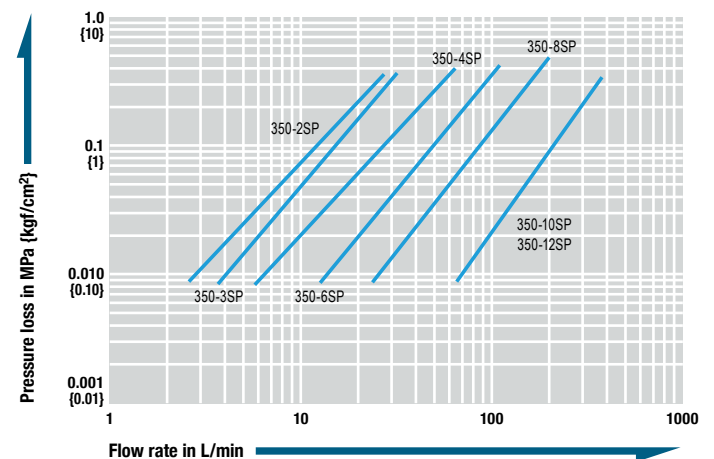

## ⚠ Precautions for use

Do not connect / disconnect CUPLA when pressure is applied or remaining.

Models and Dimensions

Product appearance may vary by size. / WAF : WAF stands for width across flats.

**Plug** Female thread

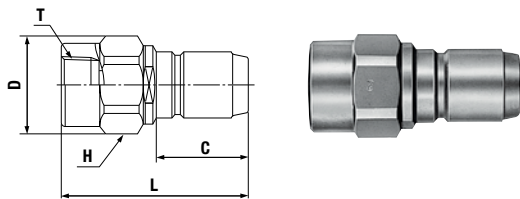

Model	Application (Thread)	Mass (g)	Dimensions (mm)				
			L	C	øD	H(WAF)	T
350-2P	R 1/4	170	(72)	36	29	Hex.27	Rc 1/4
350-3P	R 3/8	167	(72)	36	29	Hex.27	Rc 3/8
350-4P	R 1/2	245	85	40.5	30	Hex.27	Rc 1/2
350-6P	R 3/4	415	87	44.5	40	Hex.36	Rc 3/4
350-8P	R 1	950	111	57	55	Hex.50	Rc 1
350-10P	R 1 1/4	2,700	(144)	75	78	Hex.70	Rc 1 1/4
350-12P	R 1 1/2	2,600	(144)	75	78	Hex.70	Rc 1 1/2

\* G thread is available on request.

**Socket** Female thread

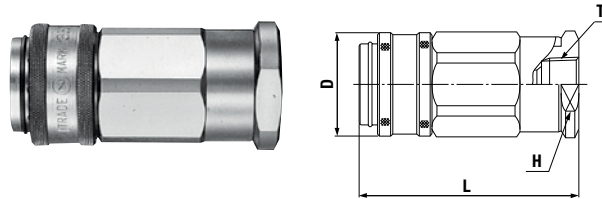

Model	Application (Thread)	Mass (g)	Dimensions (mm)			
			L	øD	H(WAF)	T
350-2S	R 1/4	360	(82)	(34)	Hex.30	Rc 1/4
350-3S	R 3/8	353	(82)	(34)	Hex.30	Rc 3/8
350-4S	R 1/2	545	(93.5)	(41)	Hex.36	Rc 1/2
350-6S	R 3/4	976	(105.5)	(49)	46 x ø52	Rc 3/4
350-8S	R 1	1,740	(129)	(63)	55 x ø62	Rc 1
350-10S	R 1 1/4	5,600	(180)	89	Hex.80 x ø90	Rc 1 1/4
350-12S	R 1 1/2	5,500	(180)	89	Hex.80 x ø90	Rc 1 1/2

\* G thread is available on request.

Application Example

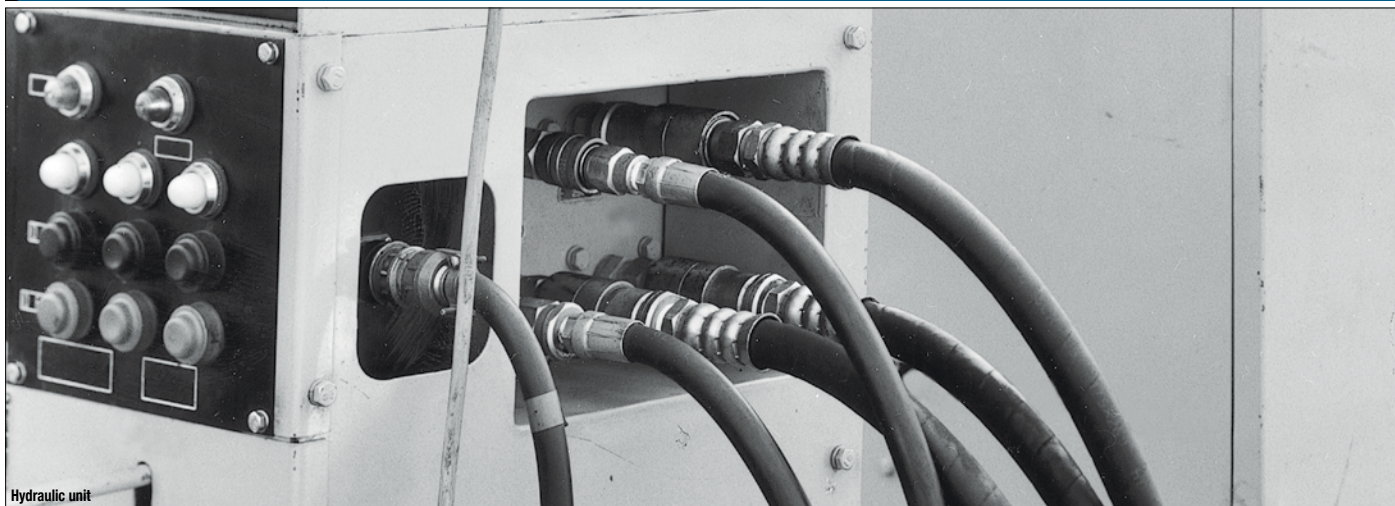

Optional Accessory

# PURGE ADAPTER

Residual Pressure Purge Adapter for Hydraulic Lines

• Can be attached to hydraulic lines to purge residual pressure effectively.

See page 153 for the details.

Specifications

Model	PAD-2	PAD-3FM	PAD-4FM	PAD-6FM	PAD-8FM
Body material	Steel (Nickel plated)				
Application (Thread)	R 1/4	R 3/8 x Rc 3/8	R 1/2 x Rc 1/2	R 3/4 x Rc 3/4	R 1 x Rc 1
Pressure unit	MPa	kgf/cm <sup>2</sup>	bar	PSI	
Working pressure	35.0	357	350	5080	
Drain outlet port	For 8 mm OD tube	Application: Rc 1/8 (Max. Tightening Torque: 5 Nm)			
Applicable fluids	Hydraulic oil				
Seal material	Nitrile rubber	NBR (SG)	-5°C to +80°C	Standard material	
Working temperature range					





Before use, please be sure to read "Safety Guide" described at the end of this book and "Instruction Sheet" that comes with the products.

# For High Pressure

# FLAT FACE CUPLA

## F35

For hydraulic pressures up to 35.0 MPa {357 kgf/cm<sup>2</sup>} with flat contact face

<p>Working pressure</p>  <p>35.0 MPa {357 kgf/cm<sup>2</sup>}</p>	<p>Valve structure</p>  <p>Two-way shut-off (Non-Spill)</p>	<p>Applicable fluid</p>  <p>Hydraulic oil</p>
---	--	--

## Flat contact face design reduces spill upon disconnection.

- Flat contact face design makes it easy to clean dust and foreign matter adhered on the surface of coupling so as to prevent them from entering inside and thus causing faulty operation of connection or disconnection.
- Flat contact face design minimizes air admixture during connection to keep the possible malfunction of equipment caused by the air bubbles in the hydraulic line at minimum level.
- Push-to-connect operation.
- Sleeve stopper mechanism is engaged by rotating sleeve after connection. It prevents accidental disconnection even when vibration or impact is applied to the CUPLA.
- The special design reduces pressure loss considerably, and especially suited to hydraulic applications in which big flow is needed. Both socket and plug have built-in automatic shut-off valves that prevent fluid spill out on disconnection.

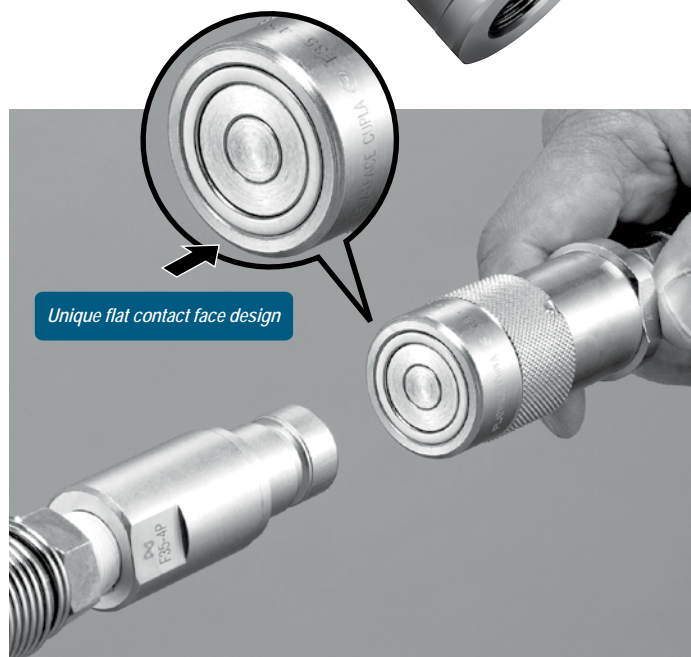

Specifications				
Body material	Special steel (Nickel plated)			
Size (Thread)	1/4", 3/8", 1/2", 3/4", 1"			
Pressure unit	MPa	kgf/cm <sup>2</sup>	bar	PSI
Working pressure	35.0	357	350	5080
Seal material Working temperature range	Seal material	Mark	Working temperature range	Remarks
	Fluoro rubber	FKM (X-100)	-20°C to +180°C	Standard material
	Nitrile rubber	NBR (SG)	-20°C to +80°C	Made-to-order item

Maximum Tightening Torque		Nm {kgf·cm}				
Size (Thread)		1/4"	3/8"	1/2"	3/4"	1"
Torque		28 {286}	40 {408}	80 {816}	150 {1530}	250 {2550}

### Flow Direction

Fluid flow can be bi-directional when socket and plug are connected.



### Interchangeability

Socket and plug of different sizes cannot be connected.

### Minimum Cross-Sectional Area (mm<sup>2</sup>)

Model	F35-2SP	F35-3SP	F35-4SP	F35-6SP	F35-8SP
Minimum cross-sectional area	21.2	32.2	78.5	149.6	227.0

### Suitability for Vacuum

Not suitable for vacuum application in either connected or disconnected condition.

### Admixture of Air on Connection (mL)

Model	F35-2SP	F35-3SP	F35-4SP	F35-6SP	F35-8SP
Volume of air	0.1	0.1	0.2	0.3	0.4

### Flow Rate – Pressure Loss Characteristics

[Test conditions] • Fluid : Hydraulic oil • Temperature : 30°C±5°C  
• Fluid viscosity : 32 x 10<sup>-6</sup> m<sup>2</sup>/s • Density : 0.87 x 10<sup>3</sup> kg/m<sup>3</sup>

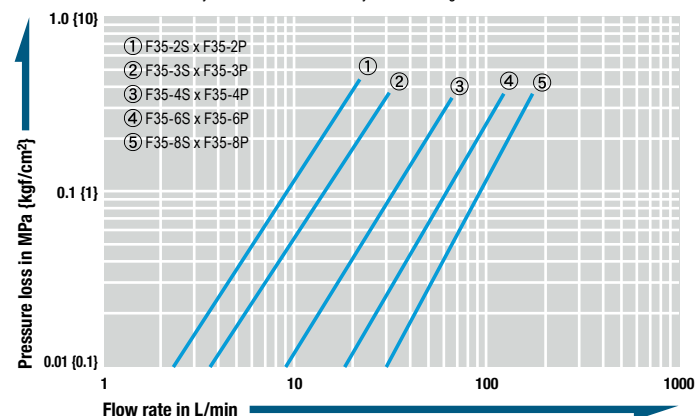

### ⚠ Precautions for use

Do not connect / disconnect CUPLA when pressure is applied or remaining.



Models and Dimensions

**Plug Female thread**

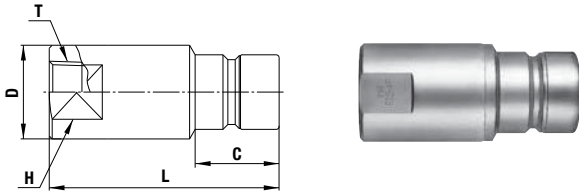

Model	Application (Thread)	Mass (g)	Dimensions (mm)				
			L	C	øD	H(WAF)	T
F35-2P	R 1/4	106	58	18.8	21.5	19	Rc 1/4
F35-3P	R 3/8	190	67.5	24	27	24	Rc 3/8
F35-4P	R 1/2	290	78	28.5	31.7	27	Rc 1/2
F35-6P	R 3/4	460	84.5	31	40	36	Rc 3/4
F35-8P	R 1	1000	108	39	50	46	Rc 1

**Socket Female thread**

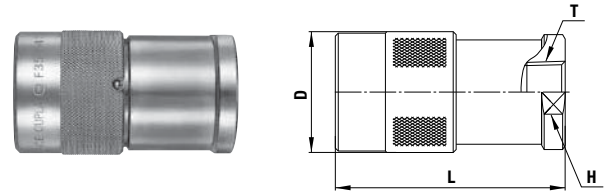

Model	Application (Thread)	Mass (g)	Dimensions (mm)			
			L	øD	H(WAF)	T
F35-2S	R 1/4	182	(57.5)	(28)	26 x ø28.5	Rc 1/4
F35-3S	R 3/8	320	(70)	(34)	30	Rc 3/8
F35-4S	R 1/2	490	(78)	(41)	36	Rc 1/2
F35-6S	R 3/4	815	(85)	(49)	46 x ø50	Rc 3/4
F35-8S	R 1	1520	(104)	(63)	55	Rc 1

Application Example





Snow plow



For High Pressure

# FLAT FACE CUPLA FF

For hydraulic pressure up to 35.0 MPa {357 kgf/cm<sup>2</sup>} with flat contact face

<p>Working pressure</p>  <p>35.0 MPa {357 kgf/cm<sup>2</sup>}</p>	<p>Valve structure</p>  <p>Two-way shut-off (Non-Spill)</p>	<p>Applicable fluid</p>  <p>Hydraulic oil</p>
---	--	--

Compared with Nitto Kohki's conventional 35 MPa CUPLA, the flow volume is increased 1.5 to 2 times.

\*Increase ratio of each flow volume depends on the CUPLA size.

- "Airless valve shut-off" design minimizes spillage volume on disconnection and admixture volume of air on connection.
  - Best suited for hydraulic lines with drastic high pressure pulsation such as in die-casting machines.
  - Sleeve stopper design preventing accidental disconnection under vibration or impacts enhances workability and safety.
  - Sizes are Rc 3/8, Rc 1/2, Rc 3/4, and Rc 1.
- \*Only the same size of socket and plug can be connected.



Offset concave flat face enables quick and smooth connection

## Unique flat face design

Concaved offset for the flat face on socket guides plug for quick and smooth centering and connection, but still easy to wipe off dirt and dusts.



Hexagon nut for easy mount

## Specifications

Body material	Special steel (Nickel plated)			
Size (Thread)	3/8", 1/2", 3/4", 1"			
Pressure unit	MPa	kgf/cm <sup>2</sup>	bar	PSI
Working pressure	35.0	357	350	5080
Seal material	Seal material	Mark	Working temperature range	Remarks
Working temperature range	Nitrile rubber	NBR	-20°C to +80°C	Standard material

## Maximum Tightening Torque

Nm {kgf·cm}

Size (Thread)	3/8"	1/2"	3/4"	1"
Torque	40 {408}	80 {816}	150 {1530}	250 {2550}

## Flow Direction

Fluid flow can be bi-directional when socket and plug are connected.



## Interchangeability

Socket and plug of different sizes cannot be connected.

## Minimum Cross-Sectional Area

(mm<sup>2</sup>)

Model	FF-3S x FF-3P	FF-4S x FF-4P	FF-6S x FF-6P	FF-8S x FF-8P
Minimum cross-sectional area	51	106	215	332

## Suitability for Vacuum

Not suitable for vacuum application in either connected or disconnected condition.

## Admixture of Air on Connection

May vary depending upon the usage conditions.

(mL)

Model	FF-3S x FF-3P	FF-4S x FF-4P	FF-6S x FF-6P	FF-8S x FF-8P
Volume of air admixture	0.018	0.029	0.033	0.080

## Volume of Spillage per Disconnection

May vary depending upon the usage conditions.

(mL)

Model	FF-3S x FF-3P	FF-4S x FF-4P	FF-6S x FF-6P	FF-8S x FF-8P
Volume of spillage	0.009	0.023	0.031	0.110

## Flow Rate – Pressure Loss Characteristics

[Test conditions] • Fluid : Hydraulic oil • Temperature : 30°C±5°C  
• Fluid viscosity : 32 x 10<sup>-6</sup> m<sup>2</sup>/s • Density : 0.87 x 10<sup>3</sup> kg/m<sup>3</sup>

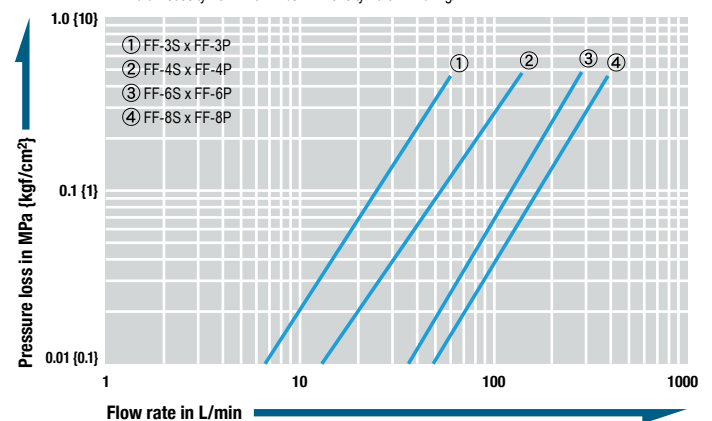

## ⚠ Precautions for use

Do not connect / disconnect CUPLA when pressure is applied or remaining.

Models and Dimensions

**Plug Female thread**

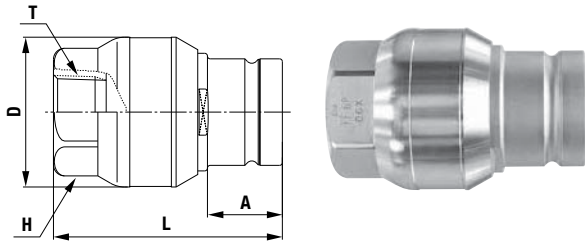

Model	Application (Thread)	Mass (g)	Dimensions (mm)				
			L	øD	A	H (WAF)	T
FF-3P	R 3/8	252	(66)	34	20.5	Hex.29	Rc 3/8
FF-4P	R 1/2	409	(74)	42	22.8	Hex.32	Rc 1/2
FF-6P	R 3/4	709	(82.5)	54	27	Hex.41	Rc 3/4
FF-8P	R 1	1314	(96.5)	66	29.5	Hex.54	Rc 1

**Socket Female thread**

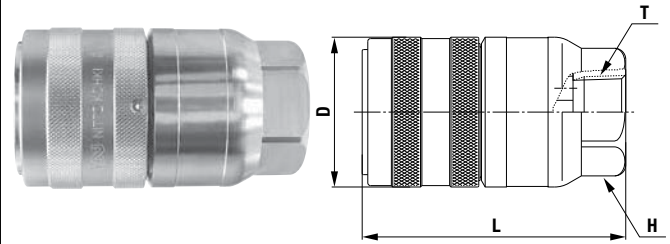

Model	Application (Thread)	Mass (g)	Dimensions (mm)			
			L	øD	H (WAF)	T
FF-3S	R 3/8	345	(71)	(35.5)	Hex.29	Rc 3/8
FF-4S	R 1/2	608	(84)	(44)	Hex.32	Rc 1/2
FF-6S	R 3/4	1053	(95)	(54)	Hex.41	Rc 3/4
FF-8S	R 1	1865	(109.5)	(66)	Hex.54	Rc 1

Applications

- Hydraulic piping for die-casting machines
- Casting machines
- Electric furnaces
- Molding presses
- Forging press
- Powdery alloy presses
- Extrusion molding machines
- Machine tools
- Iron manufacturing blast furnaces
- Continuous casting machines
- Rolling mills
- Pipe forging machines
- Furnace opening / closing machines
- Glass molding machines, etc.

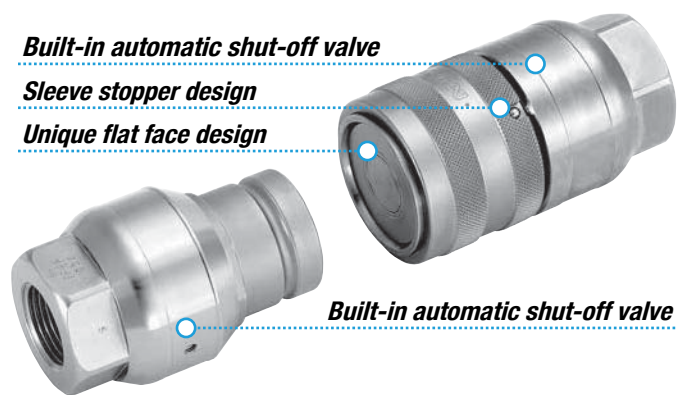

For High Pressure

# 450B CUPLA

For hydraulic pressure up to 44.1 MPa {450 kgf/cm<sup>2</sup>}

Working pressure



44.1 MPa  
{450 kgf/cm<sup>2</sup>}

Valve structure



Two-way shut-off

Applicable fluid



Hydraulic oil

**Metal-touch valve system with superior durability! Sleeve stopper mechanism gives secure connection.**

- CUPLA for higher working pressure up to 44.1 MPa {450 kgf/cm<sup>2</sup>}.
- Sleeve stopper mechanism can be engaged by rotating sleeve after connection.
- Both socket and plug have metal-touch automatic shut-off valves that prevent fluid spill out on disconnection.

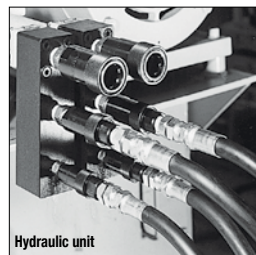

## Specifications

Body material	Special steel (Nickel plated)			
Size (Thread)	3/8"			
Pressure unit	MPa	kgf/cm <sup>2</sup>	bar	PSI
Working pressure	44.1	450	441	6400
Seal material Working temperature range	Seal material	Mark	Working temperature range	Remarks
	Nitrile rubber	NBR (SG)	-20°C to +80°C	Standard material
	Fluoro rubber	FKM (X-100)	-20°C to +180°C	Made-to-order item
Stand-alone leakage rate on either socket or plug	0.1 mL/min at 0.3 MPa {3 kgf/cm <sup>2</sup> }			

## Maximum Tightening Torque

Nm {kgf·cm}

Torque	40 (408)
--------	----------

## Flow Direction

Fluid flow can be bi-directional when socket and plug are connected.



## Minimum Cross-Sectional Area

(mm<sup>2</sup>)

Minimum cross-sectional area	37
------------------------------	----

## Suitability for Vacuum

1.3 Pa {1 x 10<sup>-2</sup> mmHg}

Socket only	Plug only	When connected
—	—	Operational

## Admixture of Air on Connection

May vary depending upon the usage conditions.

(mL)

Volume of air admixture	1.43
-------------------------	------

## Flow Rate – Pressure Loss Characteristics

[Test conditions] • Fluid : Hydraulic oil • Temperature : 25°C±5°C  
• Fluid viscosity : 32 x 10<sup>-6</sup> m<sup>2</sup>/s • Density : 0.87 x 10<sup>3</sup> kg/m<sup>3</sup>

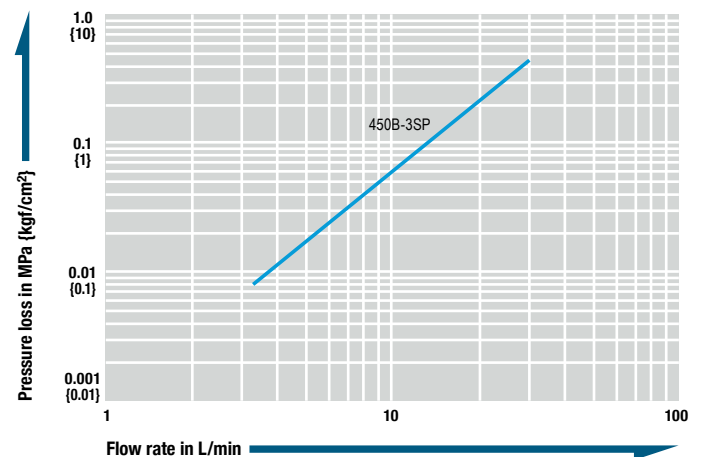

## Models and Dimensions

WAF : WAF stands for width across flats.

### Plug Female thread

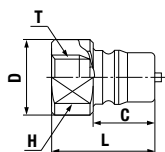

Model	Application (Thread)	Mass (g)	Dimensions (mm)				
			L	C	øD	H(WAF)	T
450B-3P	R 3/8	95	37.5	22.5	28	24	Rc 3/8

### Socket Female thread

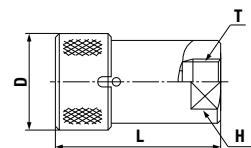

Model	Application (Thread)	Mass (g)	Dimensions (mm)			
			L	øD	H(WAF)	T
450B-3S	R 3/8	285	59.5	(36)	24	Rc 3/8

Before use, please be sure to read "Safety Guide" described at the end of this book and "Instruction Sheet" that comes with the products.

For High Pressure

# 700R CUPLA

For hydraulic pressure up to 68.6 MPa {700 kgf/cm<sup>2</sup>}

Working pressure

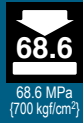

Valve structure



Applicable fluid



## High pressure CUPLA for working pressures up to 68.6 MPa.

- Metal-touch valves use no rubber seal, and thus ensure excellent durability.
- Both socket and plug have metal touch automatic shut-off valves that prevent fluid spill out on disconnection.



### Specifications

Body material	Special steel (Nickel plated)			
Size (Thread)	3/8", 1/2"			
Pressure unit	MPa	kgf/cm <sup>2</sup>	bar	PSI
Working pressure	68.6	700	686	9950
Seal material Working temperature range	Seal material	Mark	Working temperature range	Remarks
	Nitrile rubber	NBR (SG)	-20°C to +80°C	Standard material
	Fluoro rubber	FKM (X-100)	-20°C to +180°C	Made-to-order item
Stand-alone leakage rate on either socket or plug	For 700R-3SP, 0.05 mL/min at 0.2 MPa (2 kgf/cm <sup>2</sup> ) For 700R-4SP, 0.5 mL/min at 0.3 MPa (3 kgf/cm <sup>2</sup> )			

• Do not use in an environment where there is impulse pressure.

### Maximum Tightening Torque

Nm {kgf·cm}

Size (Thread)	3/8"	1/2"
Torque	40 {408}	85 {867}

### Flow Direction

Fluid flow can be bi-directional when socket and plug are connected.



### Interchangeability

Socket and plug of different sizes cannot be connected.

### Minimum Cross-Sectional Area

(mm<sup>2</sup>)

Model	700R-3SP	700R-4SP
Minimum cross-sectional area	34	55

### Suitability for Vacuum

1.3 Pa {1 × 10<sup>-2</sup> mmHg}

Socket only	Plug only	When connected
—	—	Operational

### Admixture of Air on Connection

May vary depending upon the usage conditions.

(mL)

Model	700R-3SP	700R-4SP
Volume of air admixture	1.0	2.2

### Flow Rate – Pressure Loss Characteristics

[Test conditions] • Fluid : Hydraulic oil • Temperature : 30°C±5°C  
• Fluid viscosity : 32 × 10<sup>-6</sup> m<sup>2</sup>/s • Density : 0.87 × 10<sup>3</sup> kg/m<sup>3</sup>

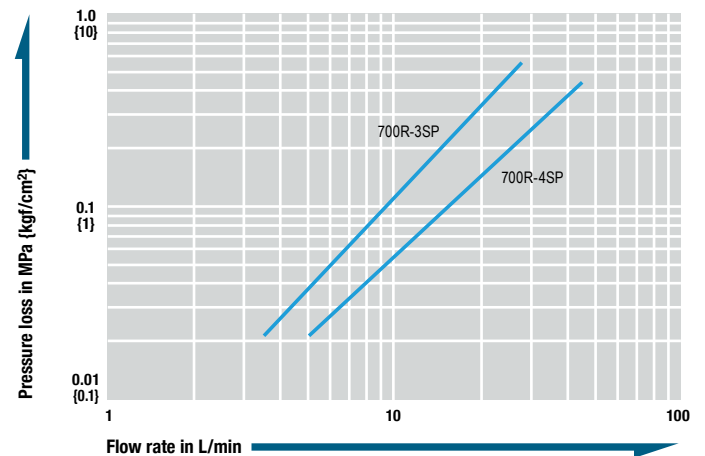

### Models and Dimensions

WAF : WAF stands for width across flats.

Model	Application (Thread)	Mass (g)	Dimensions (mm)				
			L	C	øD	H(WAF)	T
700R-3P	R 3/8	210	54	18	(39.5)	24	Rc 3/8
700R-4P	R 1/2	418	70	22	(50)	27	Rc 1/2

Model	Application (Thread)	Mass (g)	Dimensions (mm)			
			L	øD	H(WAF)	T
700R-3S	R 3/8	270	(73)	(39.5)	22	Rc 3/8
700R-4S	R 1/2	562	(91)	(50)	27	Rc 1/2

Before use, please be sure to read "Safety Guide" described at the end of this book and "Instruction Sheet" that comes with the products.



For Multi-Port Connection (Manual)

# MULTI CUPLA

## MAM Type

Multiple air port system

Working pressure



0.7 MPa  
(7 kgf/cm<sup>2</sup>)

Valve structure



One-way shut-off

Applicable fluid



Air

Simultaneously connects several ports securely in one operation!  
Greatly cuts cycle time in multiple ports replacement.

- Handles several ports at once.
- Simple action with lever enables easy connection / disconnection manually.
- Comes with lock mechanism to prevent accidental disconnection.
- Valve on socket side only.

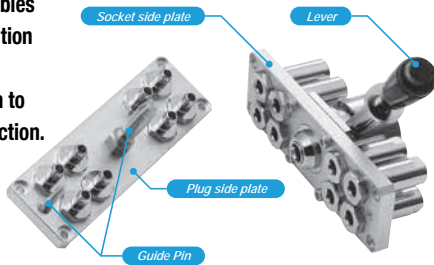

### Specifications

Body material	CUPLA : Brass (Chrome plated)			
	Plate : Aluminum alloy (4, 8, 12 ports) / Plate : Steel (16 ports) Locking unit : Steel and others			
Size (Thread)	Rc 1/8			
Pressure unit	MPa	kgf/cm <sup>2</sup>	bar	PSI
Working pressure	0.7	7	7	102
Seal material	Seal material	Mark	Working temperature range	
Working temperature range	Nitrile rubber	NBR (SG)	-20°C to +60°C	

### Maximum Tightening Torque

Nm {kgf·cm}

Torque	5 {51}
--------	--------

### Interchangeability

No connection is possible between plates with different number of ports.

### Minimum Cross-Sectional Area

(mm<sup>2</sup>)

Per port	15.9
----------	------

### Suitability for Vacuum

Not suitable for vacuum application in either connected or disconnected condition.

### Pressure - Flow Characteristics

Per port with CUPLA

[Test conditions] • Fluid : Air • Temperature : Room temperature

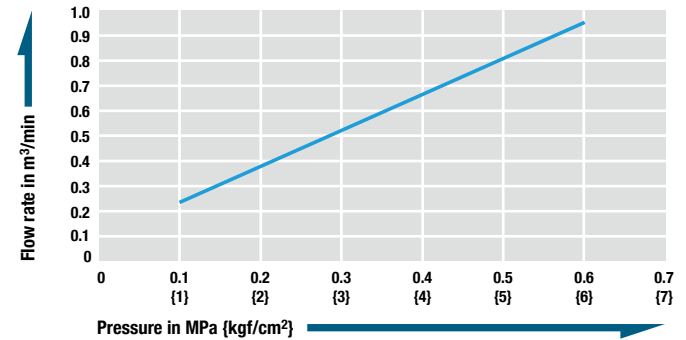

### Models and Dimensions

WAF : WAF stands for width across flats.

#### Model MAM-1TP-4 × MAM-1S-4 (4 port type)

Application (Thread): R 1/8 Mass: 150 g (Plug), 500 g (Socket)

Plug: Model MAM-1TP-4

Socket: Model MAM-1S-4

Dimensions (mm)

MAM-1TP-4 x MAM-1S-4  
(4 port type)

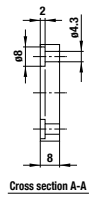
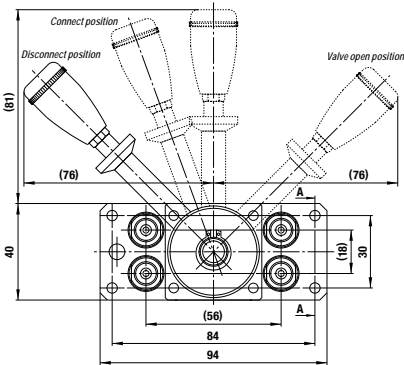
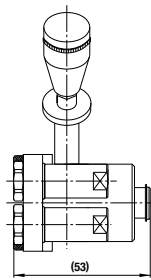
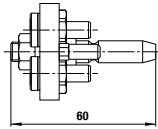
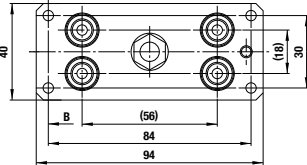
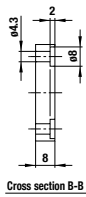
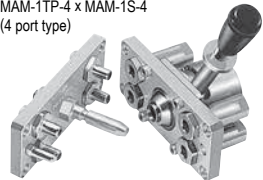

#### Model MAM-1TP-8 × MAM-1S-8 (8 port type)

Application (Thread): R 1/8 Mass: 250 g (Plug), 650 g (Socket)

Plug: Model MAM-1TP-8

Socket: Model MAM-1S-8

Dimensions (mm)

MAM-1TP-8 x MAM-1S-8  
(8 port type)

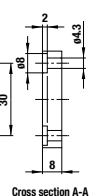
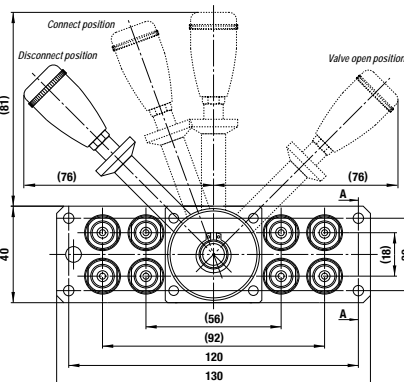
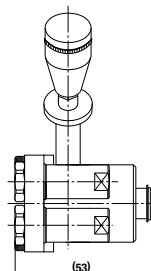
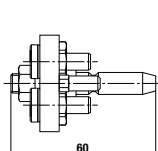
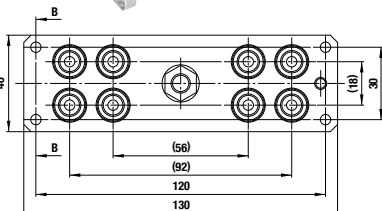
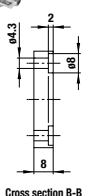
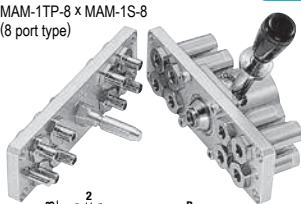



For Multi-Port Connection (Manual)

# MULTI CUPLA

## MAM-B Type

Multiple port system

Working pressure



1.0 MPa  
(10 kgf/cm<sup>2</sup>)

Valve structure



Two-way shut-off

Applicable fluids



Air

Water

Simultaneously connects several ports securely in one operation.  
Greatly reduces changeover time in multiple ports replacement.

- Handles several ports at once.
- Simple manual lever action completes easy connection / disconnection.
- Two-stage lever operation prevents CUPLA from accidental dropping due to sudden detachment.
- Comes with lock mechanism to prevent accidental disconnection.
- Large flow equivalent to that of SP CUPLA Type A.
- Two kinds of plates are available for each size.
- Automatic shut-off valves in both socket and plug prevent fluid spill out on disconnection.
- Self-aligned valve design provides safety sealing of individual socket or plug when disconnected.

MAM-B-2P6 x MAM-B-2S6  
(6 port type)

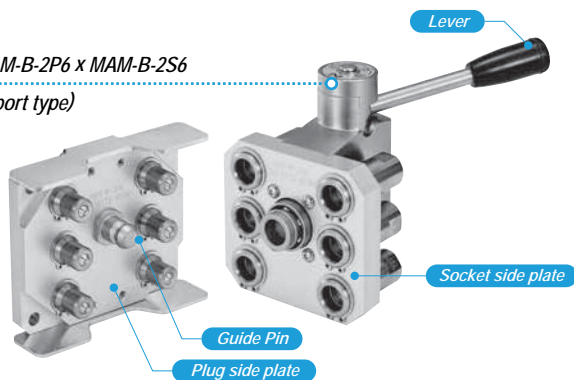

MAM-B-1P8 x MAM-B-1S8  
(8 port type)



MAM-B-1P12 x MAM-B-1S12  
(12 port type)

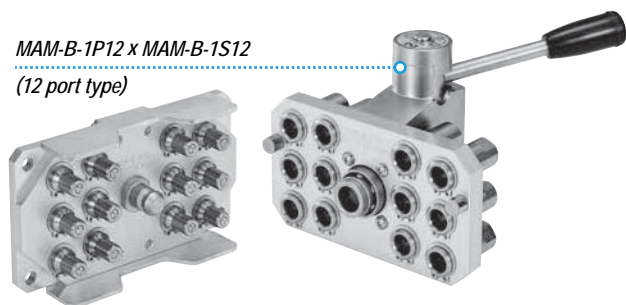

### Specifications

Model	Plug	MAM-B-1P8	MAM-B-1P12	MAM-B-2P6	MAM-B-2P8
	Socket	MAM-B-1S8	MAM-B-1S12	MAM-B-2S6	MAM-B-2S8
Number of ports		8	12	6	8
Size (Thread)		1/8"		1/4"	
Body material		CUPLA: Brass (Nickel plated) Plate: Aluminum alloy Locking unit: Steel (Nickel plated)			
Pressure unit		MPa	kgf/cm <sup>2</sup>	bar	PSI
Working pressure		1.0	10	10	145
Ambient temperature range		0°C to +60°C			
Seal material	Sealing material	Mark	Working temperature range	Remarks	
Working temperature range	Fluoro rubber	FKM (X-100)	-20°C to +180°C	Standard material	

### Maximum Tightening Torque

Nm {kgf·cm}

Size (Thread)	1/8"	1/4"
Torque	5 {51}	9 {92}

### Interchangeability

No connection is possible between plates with different number of ports or different size.

### Minimum Cross-Sectional Area per Port

(mm<sup>2</sup>)

Model	1SP type	2SP type
Minimum cross-sectional area	14	26

### Suitability for Vacuum

$1.3 \times 10^{-1}$  Pa { $1 \times 10^{-3}$  mmHg}

Socket only	Plug only	When connected
—	—	Operational

### Admixture of Air on Connection per Port

May vary depending upon the usage conditions.

(mL)

Model	1SP type	2SP type
Volume of air	0.6	1.1

### Volume of Spillage on Disconnection per Port

May vary depending upon the usage conditions.

(mL)

Model	1SP type	2SP type
Volume of spillage	0.4	0.8

### Flow Rate - Pressure Loss Characteristics

Per port of CUPLA

[Test conditions] • Fluid : Water • Temperature : 25°C±5°C

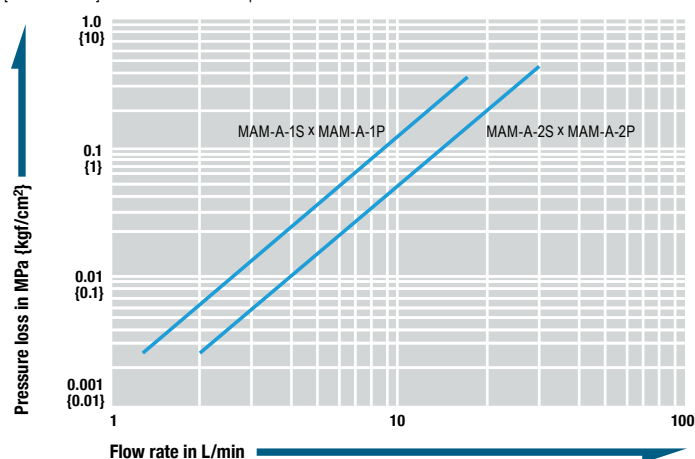

Models and Dimensions

Model MAM-B-1P8 x MAM-B-1S8 (8 port type)

• Application (Thread): R 1/8 Mass: 660 g (Plug), 1210 g (Socket)

Dimensions (mm)

Socket: Model  
MAM-B-1S8

Plug: Model  
MAM-B-1P8

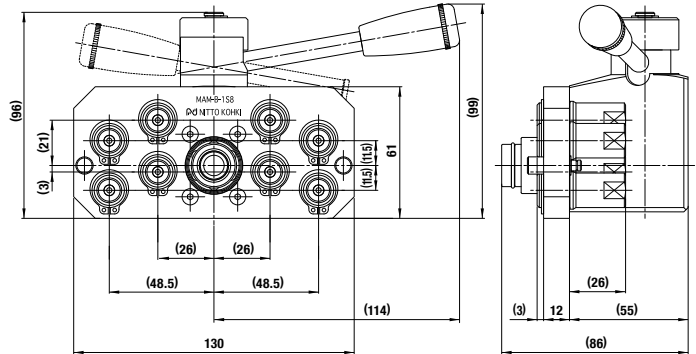
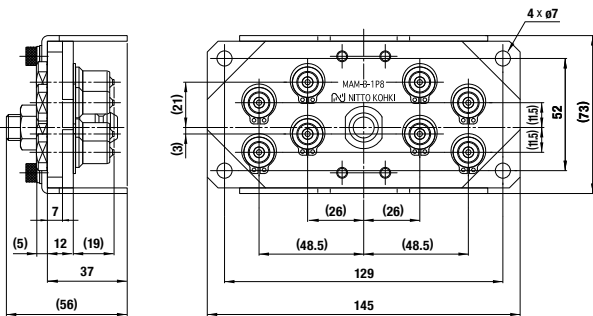
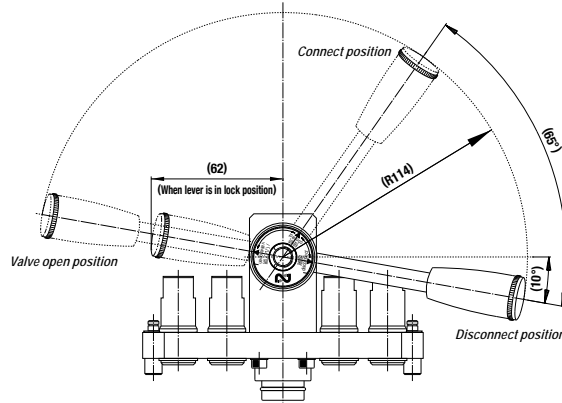

Model MAM-B-1P12 x MAM-B-1S12 (12 port type)

• Application (Thread): R 1/8 Mass: 790 g (Plug), 1430 g (Socket)

Dimensions (mm)

Socket: Model  
MAM-B-1S12

Plug: Model  
MAM-B-1P12

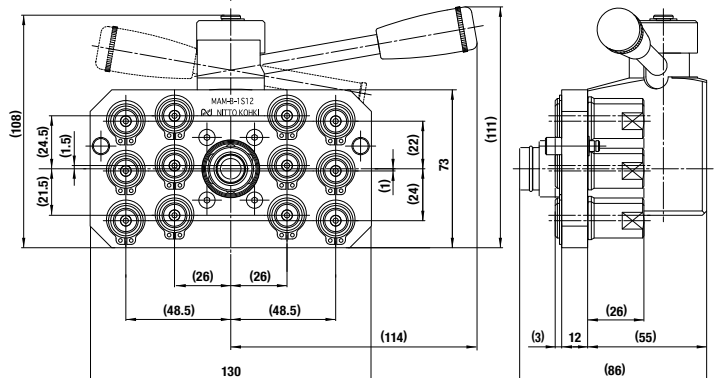
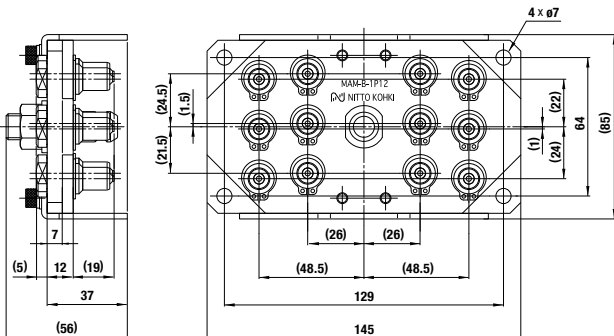
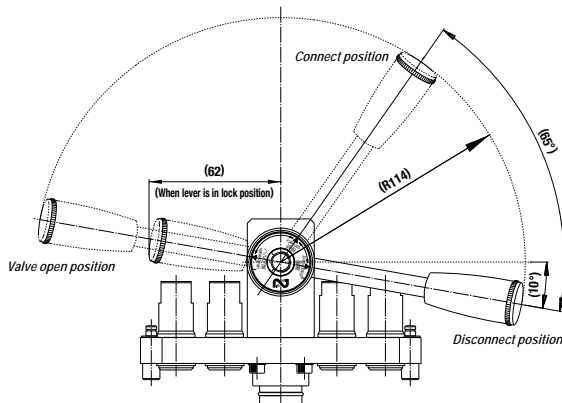

Plug Model MAM-A-1P (Individual CUPLA)

• Application (Thread): R 1/8 Mass: 25 g  
• Can be mounted on model MAM-B-1P8 and MAM-B-1P12.

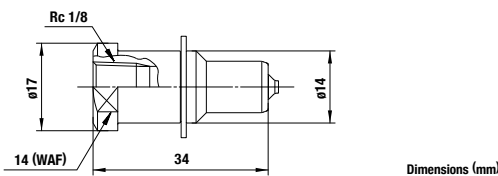

Socket Model MAM-A-1S (Individual CUPLA)

• Application (Thread): R 1/8 Mass: 49 g  
• Can be mounted on model MAM-B-1S8 and MAM-B-1S12.

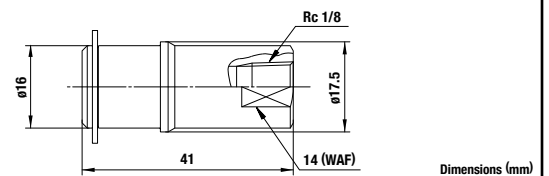

Made-to-order MULTI CUPLA are available on request, such as a combination of different sizes on the flange plate.

Before use, please be sure to read "Safety Guide" described at the end of this book and "Instruction Sheet" that comes with the products.



**Model MAM-B-2P6 x MAM-B-2S6 (6 port type)**

- Application (Thread): R 1/4 Mass: 740 g (Plug), 1280 g (Socket)

Dimensions (mm)

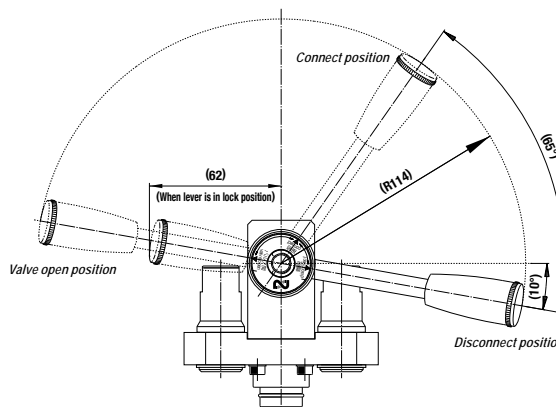

**Socket: Model  
MAM-B-2S6**

**Plug: Model  
MAM-B-2P6**

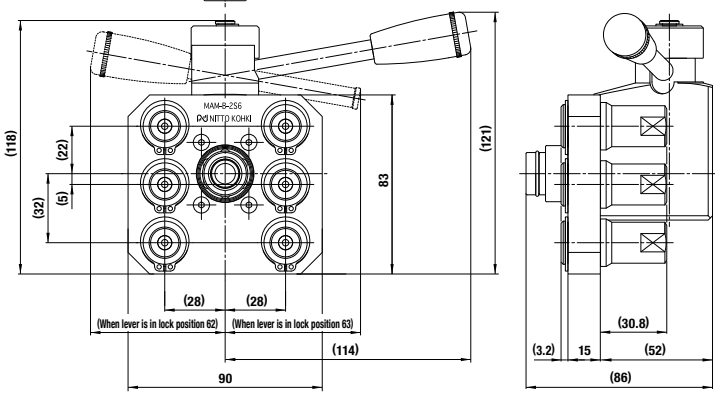
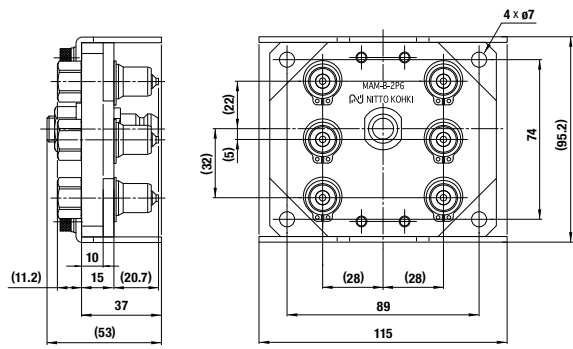

**Model MAM-B-2P8 x MAM-B-2S8 (8 port type)**

- Application (Thread): R 1/4 Mass: 920 g (Plug), 1550 g (Socket)

Dimensions (mm)

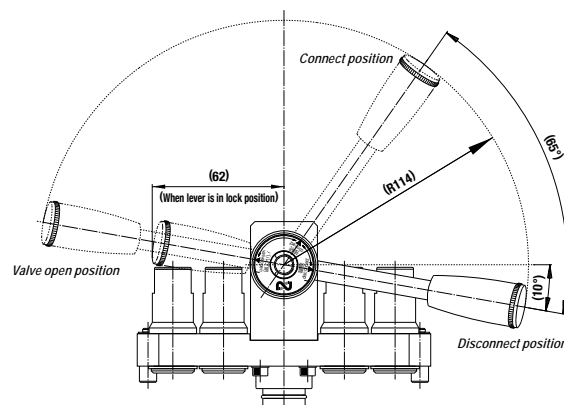

**Socket: Model  
MAM-B-2S8**

**Plug: Model  
MAM-B-2P8**

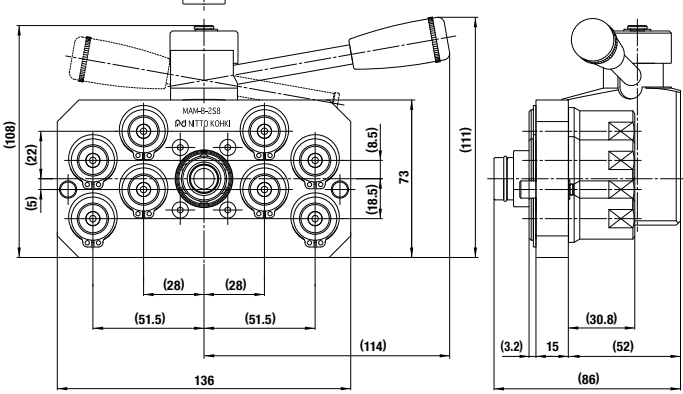
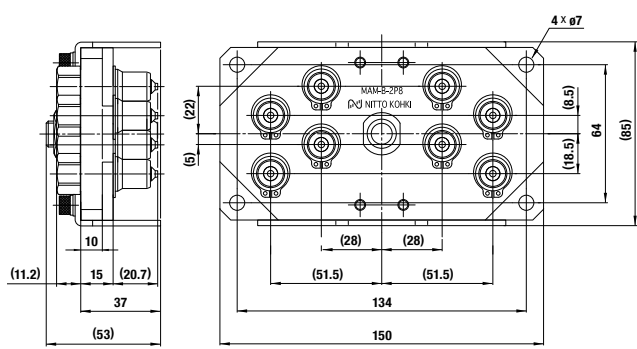

**Plug Model MAM-A-2P (Individual CUPLA)**

- Application (Thread): R 1/4 Mass: 40 g
- Can be mounted on model MAM-B-2P6 and MAM-B-2P8.

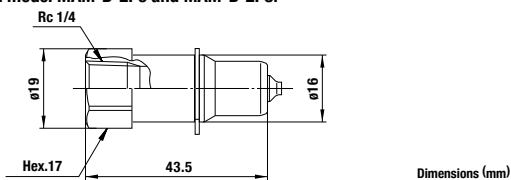

Dimensions (mm)

**Socket Model MAM-A-2S (Individual CUPLA)**

- Application (Thread): R 1/4 Mass: 82 g
- Can be mounted on model MAM-B-2S6 and MAM-B-2S8.

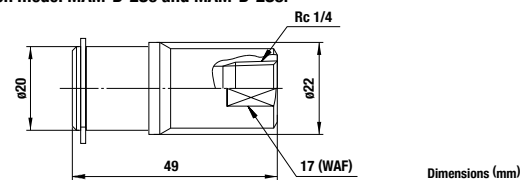

Dimensions (mm)

Made-to-order MULTI CUPLA are available on request, such as a combination of different sizes on the flange plate.

Before use, please be sure to read "Safety Guide" described at the end of this book and "Instruction Sheet" that comes with the products.

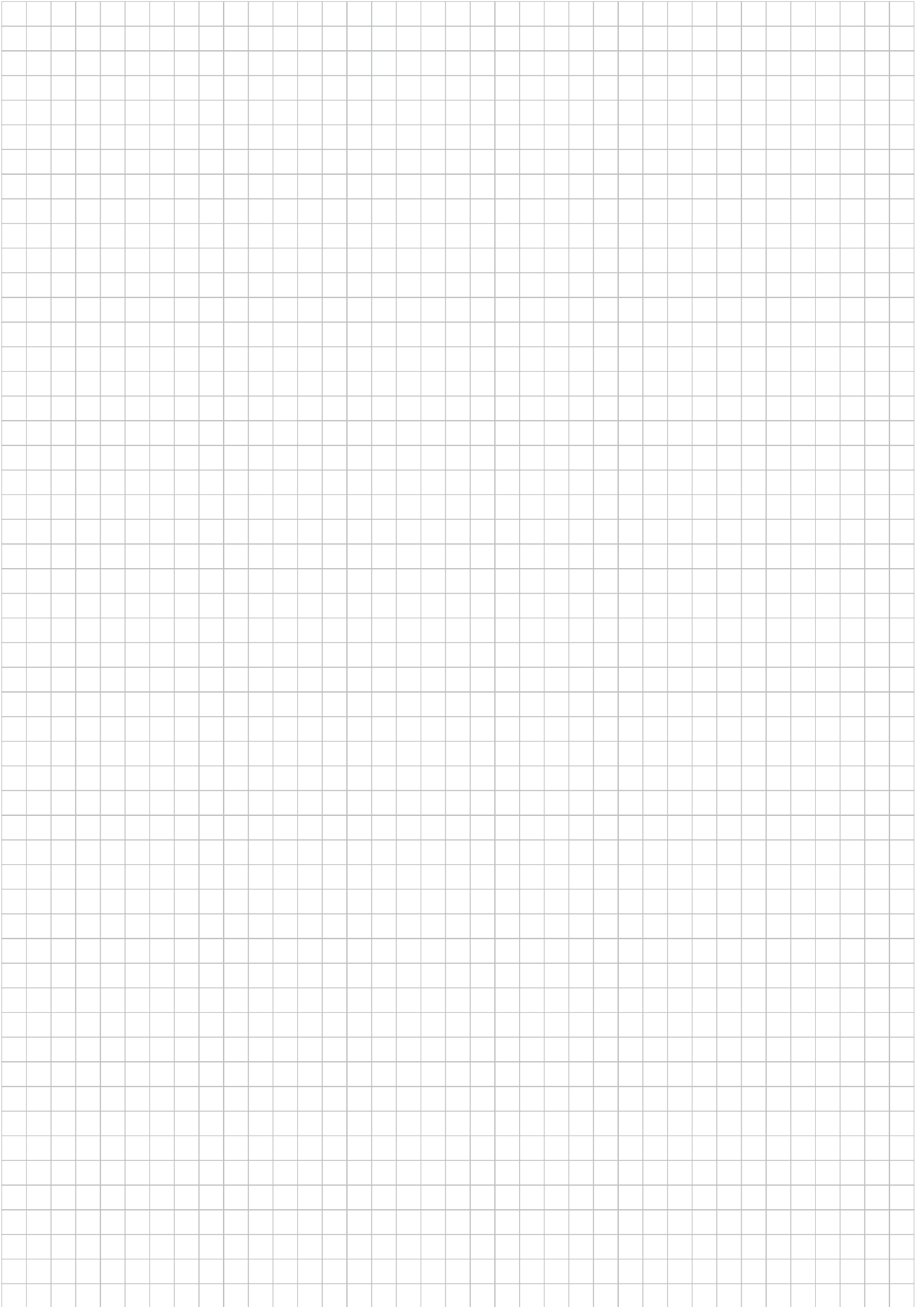

For Multi-Port Connection (Manual)

# MULTI CUPLA

## MAM-A Type

Multiple port system

Working pressure



1.0 MPa  
(10 kgf/cm<sup>2</sup>)

Valve structure



Two-way shut-off

Applicable fluids



Air

Water

Simultaneously connects several ports securely in one operation!  
Greatly reduces changeover time in multiple ports replacement.

- Handles several ports at once.
- Simple manual lever action completes easy connection / disconnection.
- Two-stage lever operation prevents CUPLA from accidental dropping due to sudden detachment.
- Comes with lock mechanism to prevent accidental disconnection.
- Large flow equivalent to that of SP CUPLA Type A.
- Two kinds of plates are available for each size.
- Automatic shut-off valves in both socket and plug prevent fluid spill out on disconnection.
- Self-aligned valve design provides safety sealing of individual socket or plug when disconnected.

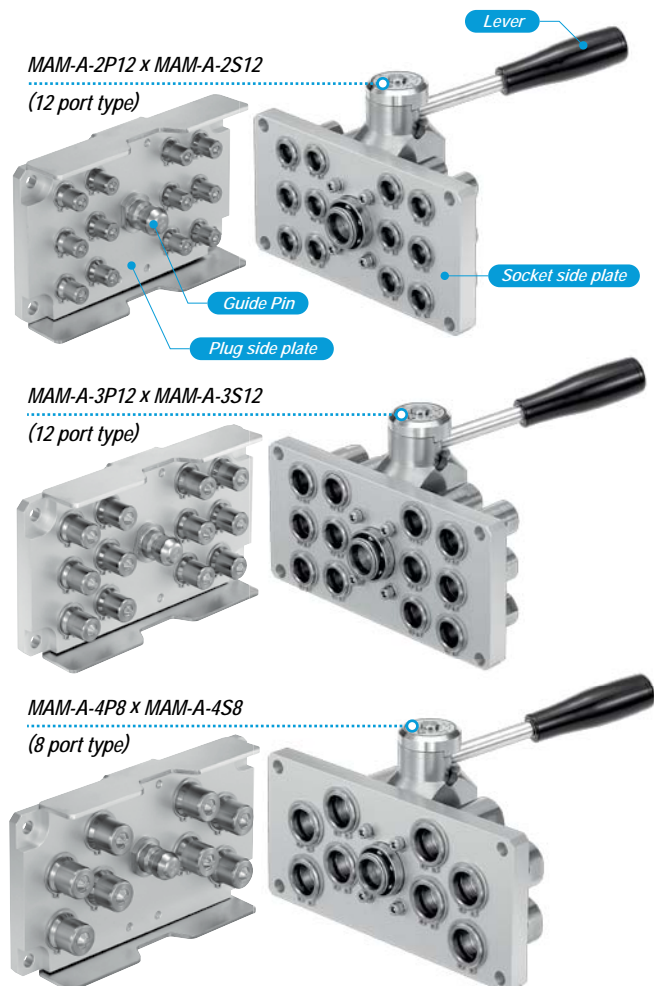

### Specifications

Model	Plug	MAM-A-2P6	MAM-A-2P12	MAM-A-3P6	MAM-A-3P12	MAM-A-4P4	MAM-A-4P8
	Socket	MAM-A-2S6	MAM-A-2S12	MAM-A-3S6	MAM-A-3S12	MAM-A-4S4	MAM-A-4S8
Number of ports		6	12	6	12	4	8
Size (Thread)		1/4"		3/8"		1/2"	
Body material		CUPLA: Brass (Nickel plated) Plate: Aluminum alloy Locking unit: Steel (Nickel plated)					
Pressure unit		MPa	kgf/cm <sup>2</sup>	bar	PSI		
Working pressure		1.0	10	10	145		
Ambient temperature range		0°C to +60°C					
Seal material	Sealing material	Mark	Working temperature range		Remarks		
Working temperature range	Fluoro rubber	FKM (X-100)	-20°C to +180°C		Standard material		

### Maximum Tightening Torque

Nm {kgf·cm}

Size (Thread)	1/4"	3/8"	1/2"
Torque	9 {92}	12 {122}	30 {306}

### Interchangeability

No connection is possible between MAM plates with different number of ports or different size.

### Minimum Cross-Sectional Area per Port

(mm<sup>2</sup>)

Model	2SP type	3SP type	4SP type
Minimum cross-sectional area	26	51	73

### Suitability for Vacuum

$1.3 \times 10^{-1}$  Pa { $1 \times 10^{-3}$  mmHg}

Socket only	Plug only	When connected
—	—	Operational

### Admixture of Air on Connection per Port

May vary depending upon the usage conditions.

(mL)

Model	2SP type	3SP type	4SP type
Volume of air	1.1	2.7	3.9

### Volume of Spillage on Disconnection per Port

May vary depending upon the usage conditions.

(mL)

Model	2SP type	3SP type	4SP type
Volume of spillage	0.8	2.1	3.4

### Flow Rate - Pressure Loss Characteristics

Per port of CUPLA

[Test conditions] • Fluid : Water • Temperature : 25°C±5°C

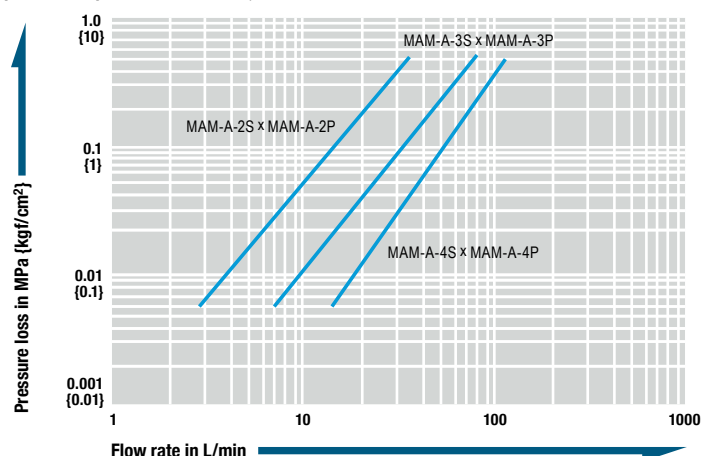

Models and Dimensions

Model MAM-A-2P6 x MAM-A-2S6 (6 port type)

• Application (Thread): R 1/4 Mass: 1100 g (Plug), 2150 g (Socket)

Dimensions (mm)

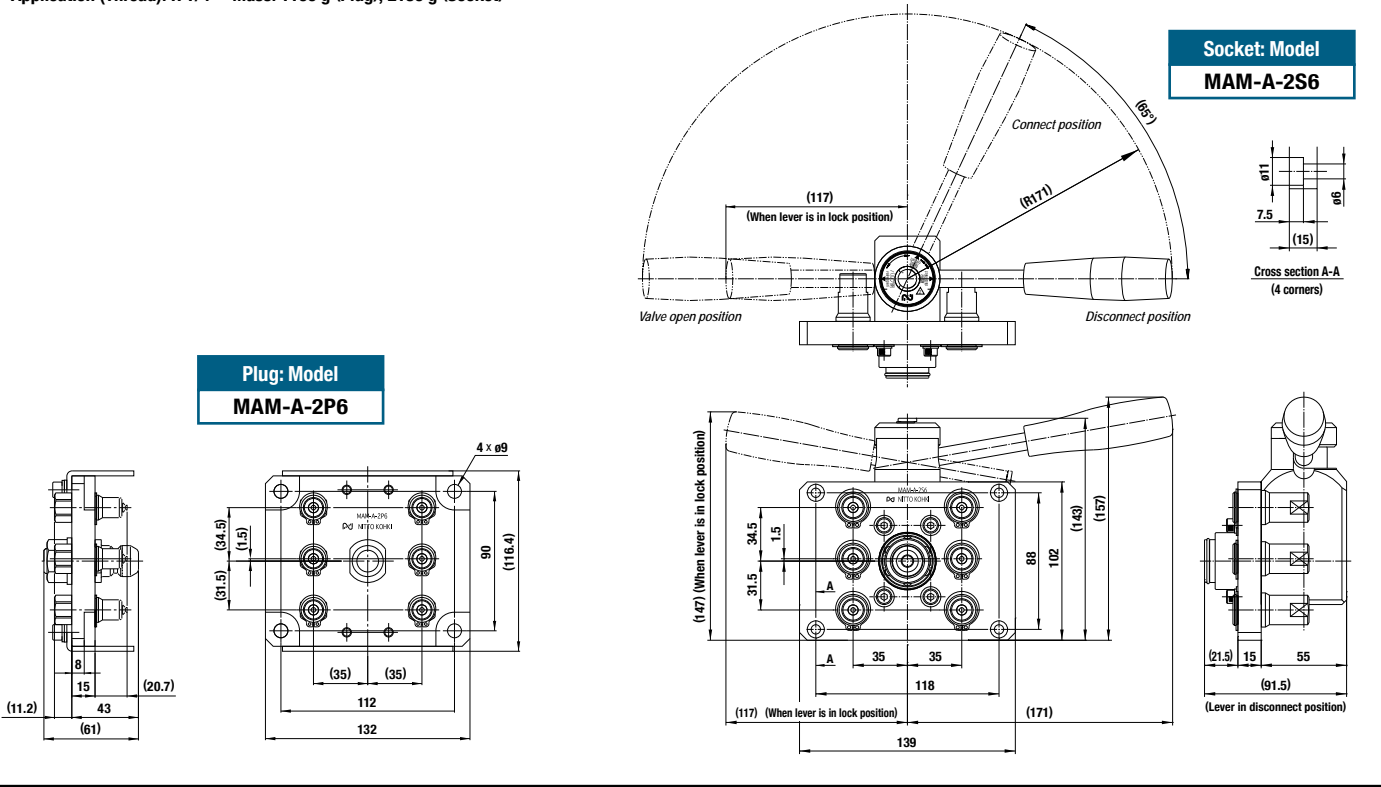

Model MAM-A-2P12 x MAM-A-2S12 (12 port type)

• Application (Thread): R 1/4 Mass: 1650 g (Plug), 2800 g (Socket)

Dimensions (mm)

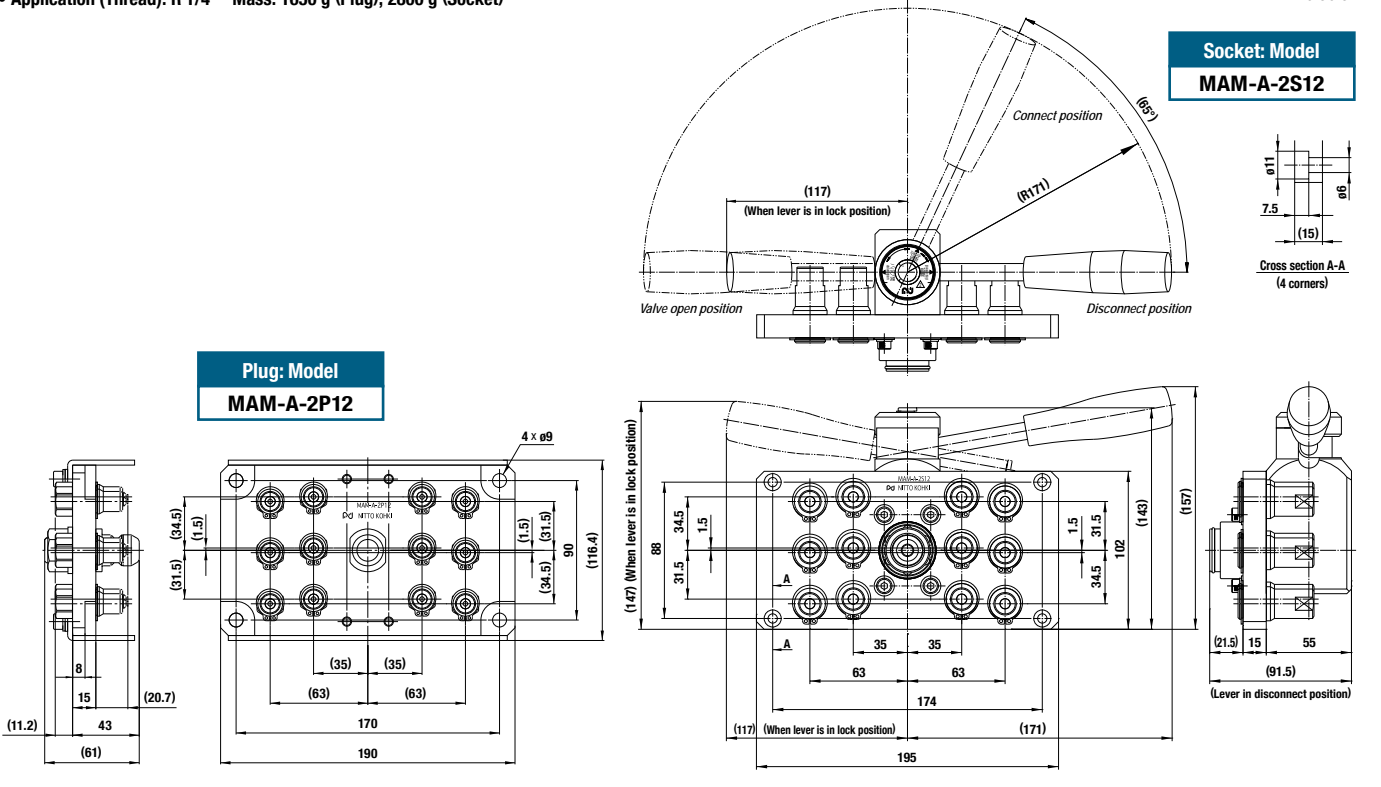

**Plug Model MAM-A-2P (Individual CUPLA)**

• Application (Thread): R 1/4 Mass: 40 g

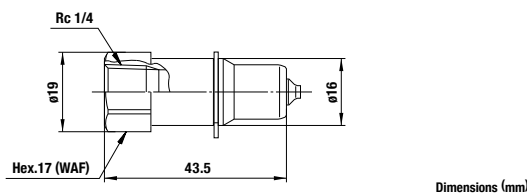

**Socket Model MAM-A-2S (Individual CUPLA)**

• Application (Thread): R 1/4 Mass: 82 g

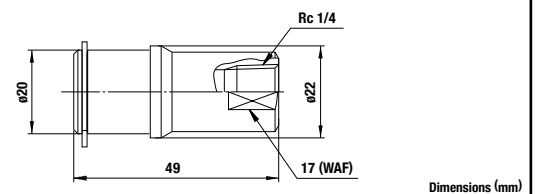

Made-to-order MULTI CUPLA are available on request, such as a combination of different sizes on the flange plate.

Before use, please be sure to read "Safety Guide" described at the end of this book and "Instruction Sheet" that comes with the products.



**Model MAM-A-3P6 x MAM-A-3S6 (6 port type)**

• Application (Thread): R 3/8 Mass: 1250 g (Plug), 2400 g (Socket)

Dimensions (mm)

**Socket: Model  
MAM-A-3S6**

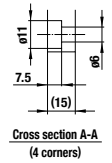
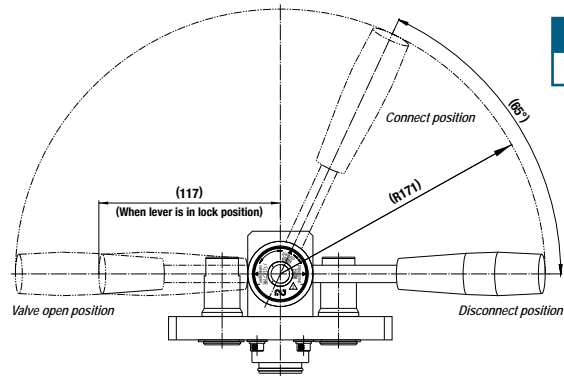

**Plug: Model  
MAM-A-3P6**

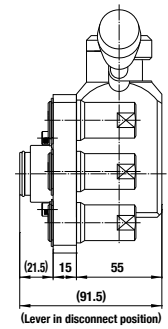
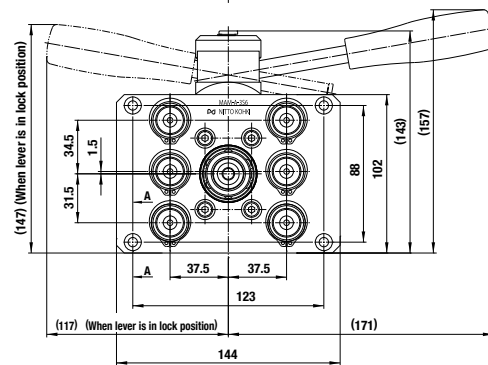
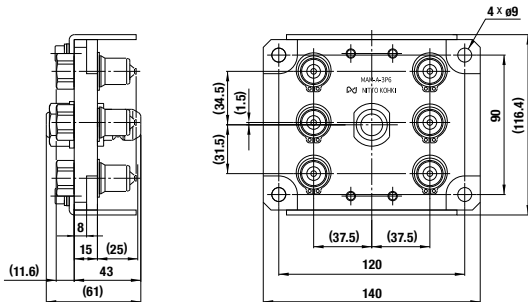

**Model MAM-A-3P12 x MAM-A-3S12 (12 port type)**

• Application (Thread): R 3/8 Mass: 1950 g (Plug), 3300 g (Socket)

Dimensions (mm)

**Socket: Model  
MAM-A-3S12**

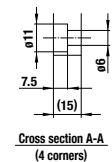
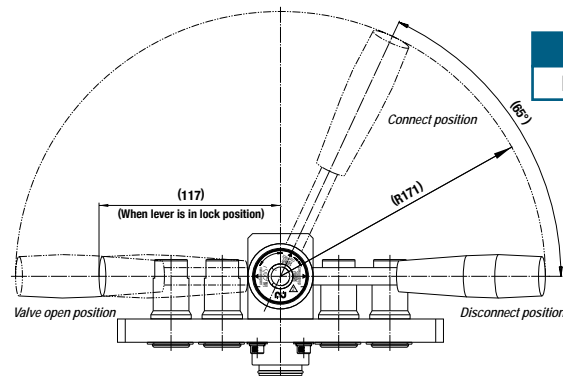

**Plug: Model  
MAM-A-3P12**

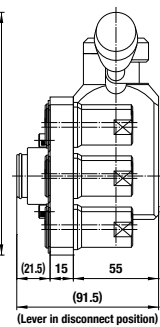
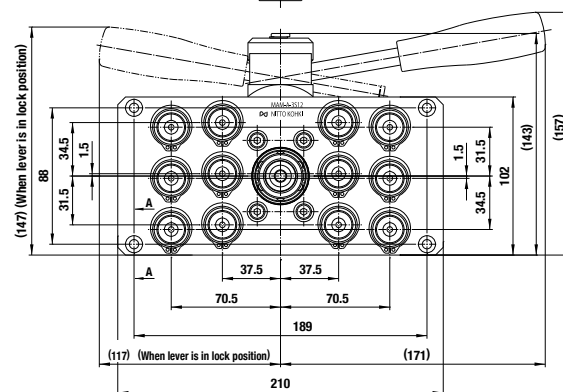
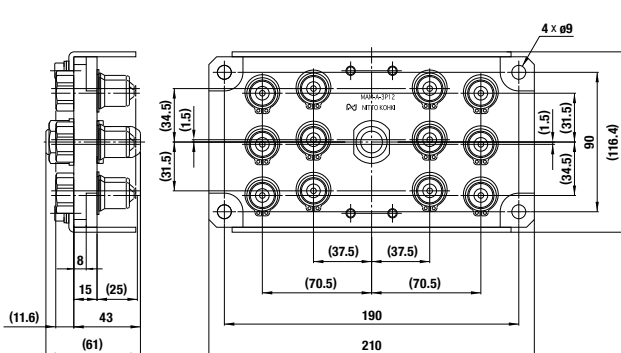

**Plug Model MAM-A-3P (Individual CUPLA)**

• Application (Thread): R 3/8 Mass: 62 g

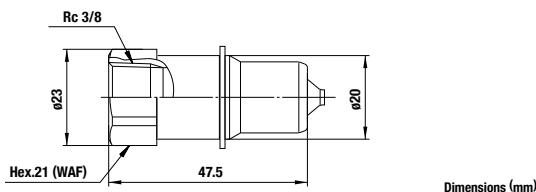

**Socket Model MAM-A-3S (Individual CUPLA)**

• Application (Thread): R 3/8 Mass: 122 g

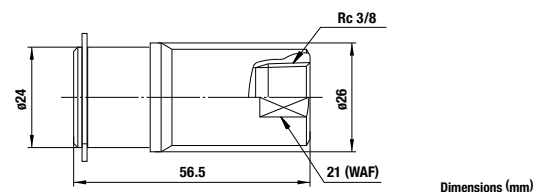

Made-to-order MULTI CUPLA are available on request, such as a combination of different sizes on the flange plate.

Before use, please be sure to read "Safety Guide" described at the end of this book and "Instruction Sheet" that comes with the products.

Models and Dimensions

Model MAM-A-4P4 x MAM-A-4S4 (4 port type)

• Application (Thread): R 1/2 Mass: 1400 g (Plug), 2700 g (Socket)

Dimensions (mm)

Socket: Model  
MAM-A-4S4

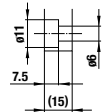
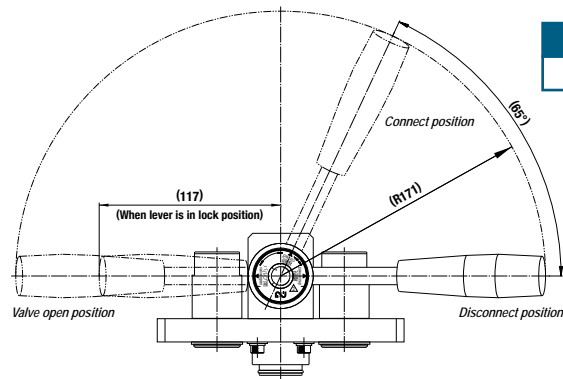

Cross section A-A  
(4 corners)

Plug: Model  
MAM-A-4P4

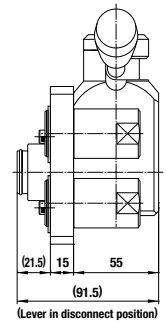
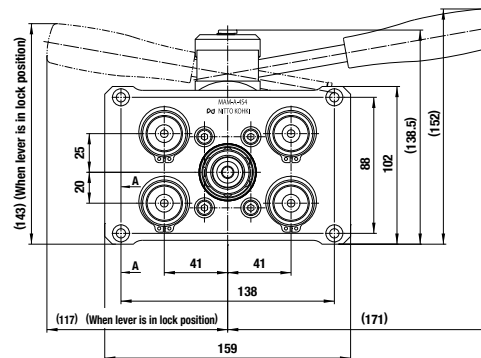
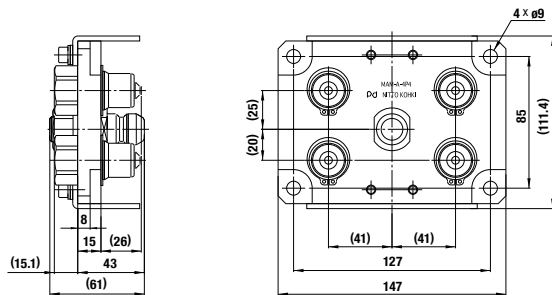

Model MAM-A-4P8 x MAM-A-4S8 (8 port type)

• Application (Thread): R 1/2 Mass: 2300 g (Plug), 4000 g (Socket)

Dimensions (mm)

Socket: Model  
MAM-A-4S8

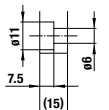
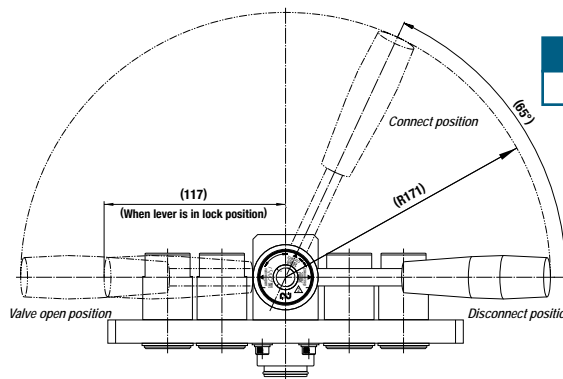

Cross section A-A  
(4 corners)

Plug: Model  
MAM-A-4P8

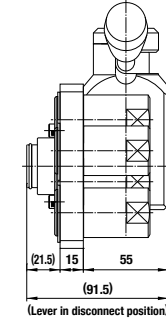
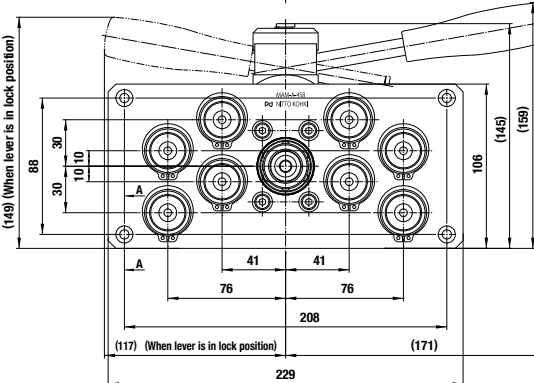
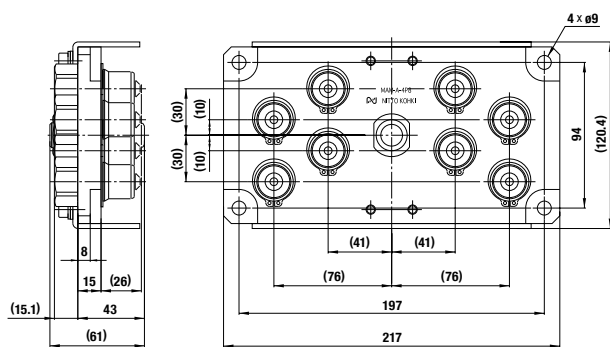

Plug Model MAM-A-4P (Individual CUPLA)

• Application (Thread): R 1/2 Mass: 127 g

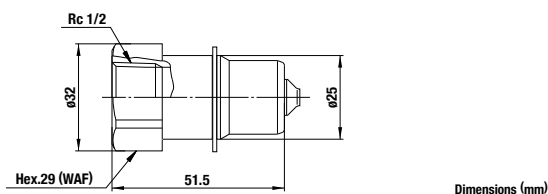

Socket Model MAM-A-4S (Individual CUPLA)

• Application (Thread): R 1/2 Mass: 256 g

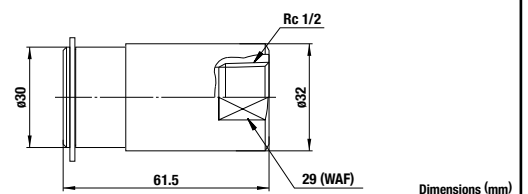

Made-to-order MULTI CUPLA are available on request, such as a combination of different sizes on the flange plate.



Before use, please be sure to read "Safety Guide" described at the end of this book and "Instruction Sheet" that comes with the products.

For Multi-Port Connection (Automatic)

# MULTI CUPLA

## MAS Type / MAT Type

7.0 MPa {71 kgf/cm<sup>2</sup>} general purpose type

<p>Working pressure</p>  <p>7.0 MPa {71 kgf/cm<sup>2</sup>}</p>	<p>Valve structure</p>  <p>Two-way shut-off</p>	<p>Applicable fluids</p>  <p>Air    Water    Hydraulic oil</p>
---	--	---

### Connects multiple lines simultaneously with a single operation for different fluids and sizes.

- Ideal for automated hydraulic or pneumatic cylinder operated systems that need to connect and disconnect several lines simultaneously.
  - Automatic shut-off valves in both sockets and plugs ensure no outflow of fluid on disconnection.
  - Body materials other than stainless steel are available, which can be ordered with or without valves (made-to-order products).
  - Snap ring and screw thread-in types to mount on the base plate are standardized.
  - MAS type can accept axial eccentricity between socket and plug. The allowance of eccentricity is within the radius range of 0.3 mm.
- \* CUPLA connection or disconnection with fluid under dynamic pressure cannot be made.

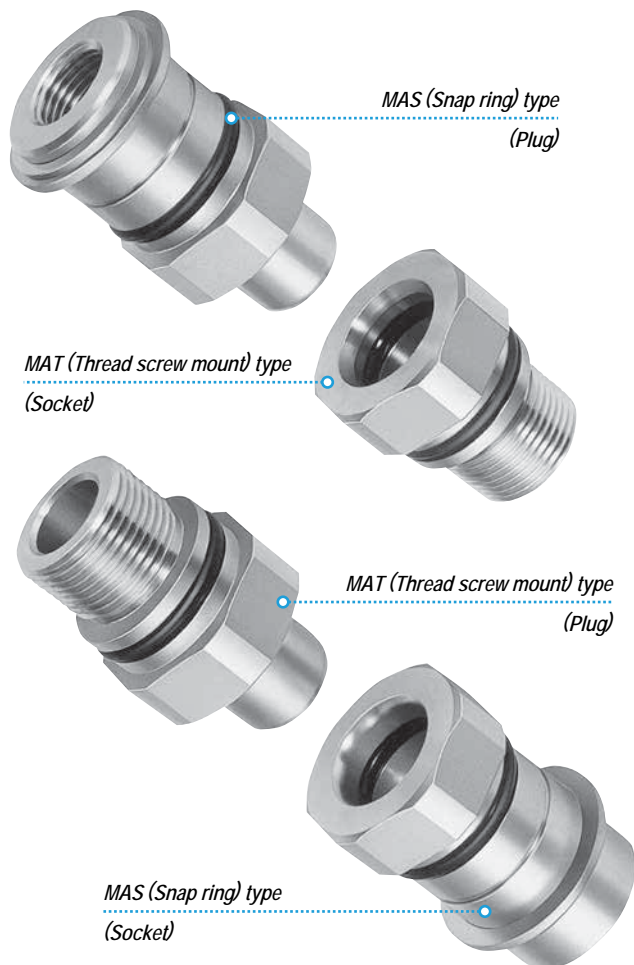

Specifications				
Body material	Stainless steel (Nickel plated)			
Pressure unit	MPa	kgf/cm <sup>2</sup>	bar	PSI
Working pressure	7.0	71	70	1020
Seal material	Sealing material	Mark	Working temperature range	
Working temperature range	Fluoro rubber	FKM (X-100)	-20°C to +180°C	

Maximum Tightening Torque					Nm {kgf·cm}				
Size (Thread)	1/4"	3/8"	1/2"	3/4"	1"				
Torque (MAS type)	14 {143}	22 {224}	60 {612}	90 {918}	120 {1224}				
Size (Thread)	M20	M24	M30	M39	M45				
Torque (MAT type)	50 {510}	50 {510}	50 {510}	70 {714}	80 {816}				

### Interchangeability

- MAS & MAT or MAS & MAS types of the same size are to be connected.
- Connection between the same MAT types is virtually not possible because there is no allowance for eccentricity.

Minimum Cross-Sectional Area						(mm <sup>2</sup> )					
Model	2SP		3SP		4SP		6SP		8SP		
Min. cross-sectional area	23		41		76		145		224		

### Suitability for Vacuum

1.3 x 10 <sup>-1</sup> Pa {1 x 10 <sup>-3</sup> mmHg}		
Socket only	Plug only	When connected
-	-	Operational

### Admixture of Air on Connection

*May vary depending upon the usage conditions.*

Admixture of Air on Connection						(mL)					
Model	2SP		3SP		4SP		6SP		8SP		
Volume of air	1.1		2.4		3.2		10.5		17.0		

### Load Required to Maintain Connection When Line Is Pressurized

Model	2SP		3SP		4SP		6SP		8SP	
Maximum acceptable load N (kgf)	3200 {327}		5200 {531}		9200 {939}		13900 {1419}		20200 {2062}	
Minimum load required to maintain connection N (kgf) *	Px185+45 {p×1.85+4.5}		Px310+70 {p×3.1+7}		Px545+85 {p×5.45+8.5}		Px850+95 {p×8.5+9.5}		Px1225+120 {p×12.25+12}	

\* Assign the actual value of pressure [P (MPa), p (kgf/cm<sup>2</sup>)] to the above formula to calculate the load. Maintain the connection with the minimum load or more, but not more than the maximum acceptable load.

### Flow Rate - Pressure Loss Characteristics

[Test conditions] • Fluid : Water • Temperature : 20°C±5°C

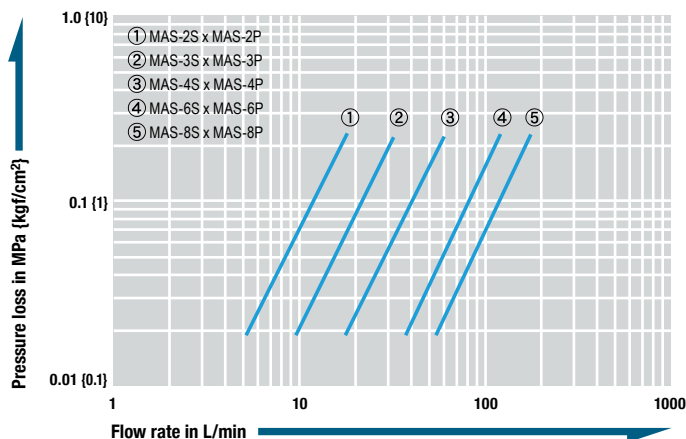

### Application Example

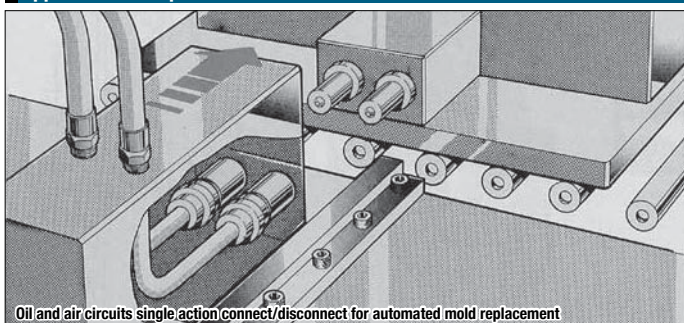

Models and Dimensions

**Plug MAS type (With snap ring)**

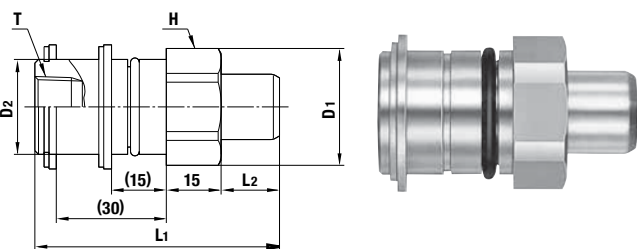

Model	Application (Thread)	Mass (g)	Dimensions (mm)					
			L1	L2	øD1	øD2	H(WAF)	T
MAS-2P	R 1/4	150	65	14	28	21.9	Hex.26	Rc 1/4
MAS-3P	R 3/8	203	67	16	35	25.9	Hex.32	Rc 3/8
MAS-4P	R 1/2	412	73	20	44	35.9	Hex.41	Rc 1/2
MAS-6P	R 3/4	579	76.5	23.5	50	41.9	Hex.46	Rc 3/4
MAS-8P	R 1	720	78	24	58	47.9	Hex.54	Rc 1

**Socket MAS type (With snap ring)**

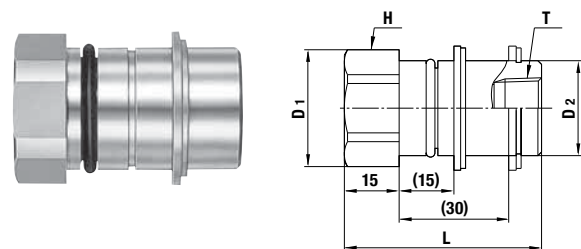

Model	Application (Thread)	Mass (g)	Dimensions (mm)				
			L	øD1	øD2	H(WAF)	T
MAS-2S	R 1/4	126	51.5	28	21.9	Hex.26	Rc 1/4
MAS-3S	R 3/8	171	55	35	25.9	Hex.32	Rc 3/8
MAS-4S	R 1/2	406	65	44	35.9	Hex.41	Rc 1/2
MAS-6S	R 3/4	604	76	50	41.9	Hex.46	Rc 3/4
MAS-8S	R 1	825	87	58	47.9	Hex.54	Rc 1

**Plug MAT type (Thread screw mount)**

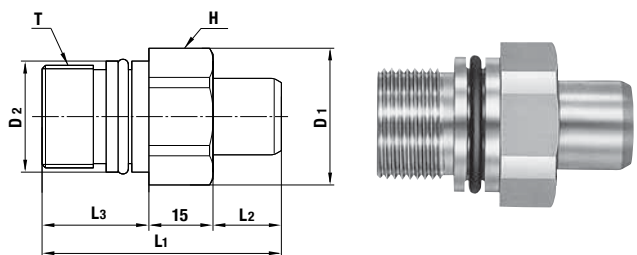

Model	Application (Thread)	Mass (g)	Dimensions (mm)						
			L1	L2	L3	øD1	øD2	H(WAF)	T
MAT-2P	See drawings below.	121	53	14	(24)	28	21.9	Hex.26	M20 x 1.5
MAT-3P		164	56	16	(25)	32	25.9	Hex.29	M24 x 1.5
MAT-4P		332	67	20	(32)	44	35.9	Hex.41	M30 x 2
MAT-6P		453	73	23.5	(34.5)	50	41.9	Hex.46	M39 x 2
MAT-8P		571	76	24	(37)	54	47.9	Hex.50	M45 x 2

**Socket MAT type (Thread screw mount)**

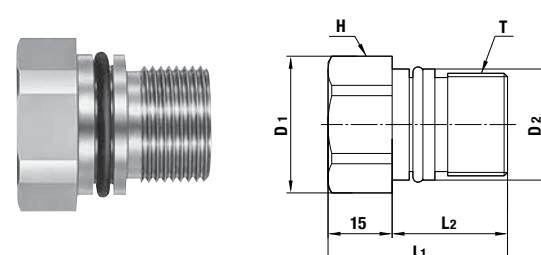

Model	Application (Thread)	Mass (g)	Dimensions (mm)					
			L1	L2	øD1	øD2	H(WAF)	T
MAT-2S	See drawings below.	95	39	(24)	28	21.9	Hex.26	M20 x 1.5
MAT-3S		124	42	(27)	32	25.9	Hex.29	M24 x 1.5
MAT-4S		246	48	(33)	44	35.9	Hex.41	M30 x 2
MAT-6S		382	58	(43)	50	41.9	Hex.46	M39 x 2
MAT-8S		506	66	(51)	54	47.9	Hex.50	M45 x 2

• MAT type must be coupled with MAS type.

Dimensions of End Configurations

MAS Type

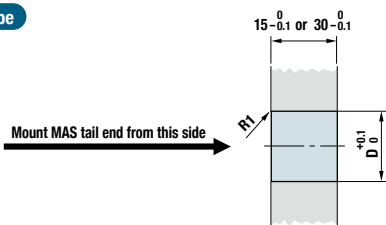

Model	Dimensions (mm)	
	øD	
MAS-2S / MAS-2P	23	
MAS-3S / MAS-3P	27	
MAS-4S / MAS-4P	37	
MAS-6S / MAS-6P	43	
MAS-8S / MAS-8P	49	

MAT Type

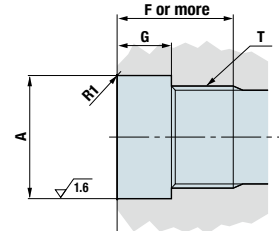

Model	Dimensions (mm)				
	øA	G	F		T
			Plug	Socket	
MAT-2S / MAT-2P	22 <sup>+0.06</sup> <sub>0</sub>	13	25		M20 x 1.5
MAT-3S / MAT-3P	26 <sup>+0.06</sup> <sub>0</sub>	13	26	28	M24 x 1.5
MAT-4S / MAT-4P	36 <sup>+0.08</sup> <sub>0</sub>	16	34	35	M30 x 2
MAT-6S / MAT-6P	42 <sup>+0.08</sup> <sub>0</sub>	17	36.5	45	M39 x 2
MAT-8S / MAT-8P	48 <sup>+0.08</sup> <sub>0</sub>	17	39	53	M45 x 2





For Multi-Port Connection (Automatic)

# MULTI CUPLA

**MALC-01 Type** for Low Pressure Use

One-way shut-off type for Low pressure use

Working pressure  1.0 MPa {10 kgf/cm <sup>2</sup> }	Valve structure  One-way shut-off	Applicable fluids  Air Water
--	--	---

**Solo use of socket is possible.**  
Suitable for operation of ejector pins to open / close valve gates in molding.

- Solo use of socket is possible.
- As in the case of MULTI CUPLA MALC-SP type and MALC-HSP type, the distance between the socket plate and the plug plate is designed to be 30 mm when connected. This means the MULTI CUPLA MALC-01 type can also be installed mixed with any size of MALC-SP type and MALC-HSP type on the same plate.
- An axial eccentricity allowance of 2 mm eliminates precise centering at installation.
- Compact size with " thread screw mount " and "with flange" types available.



Specifications				
Body material	Socket: Brass (Nickel plated) Plug: Brass (Nickel plated)			
Pressure unit	MPa	kgf/cm <sup>2</sup>	bar	PSI
Working pressure	1.0	10	10	145
Seal material	Sealing material	Mark	Working temperature range	
Working temperature range	Nitrile rubber	NBR (SG)	-20°C to +80°C	

Maximum Tightening Torque		Nm {kgf·cm}
Thread screw mount	15 {153}	
Flange	1.5 {15}	

- Interchangeability**
- Sockets and plugs can be connected regardless of end configurations.
  - Not interchangeable with MALC-SP Type (for medium pressure use) MALC-1SP or MALC-HSP Type (for high pressure use) MALC-1HSP.

Minimum Cross-Sectional Area		(mm <sup>2</sup> )
Minimum cross-sectional area	28	

**Suitability for Vacuum**  
Not suitable for vacuum application in either connected or disconnected condition.

**Load Required to Maintain Connection When Line Is Pressurized**

$$F = (P \times 160) + 50 \{ f = p \times 1.6 + 5 \}$$

Minimum load required to maintain connection F [N] {f [kgf]}

Actual value of pressure P [MPa] {p [kgf/cm<sup>2</sup>]}

Assign the actual value of pressure [P (MPa), p (kgf/cm<sup>2</sup>)] to the above formula. Maintain the connection with this load [F (N), f (kgf)] or more. However, the maximum acceptable load is 500 N {51 kgf}.

**Pressure - Flow Characteristics**

[Test conditions] • Fluid : Air • Temperature : Room temperature

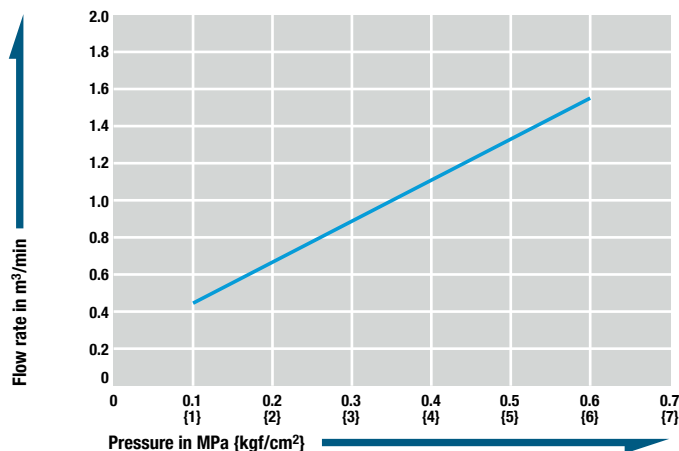

**Acceptable distance between plates**

Socket and plug or plate must be used in contact with each other. Maximum 0.5 mm distance between socket and plug or plate is acceptable.

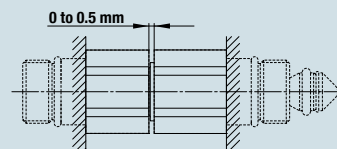

Models and Dimensions

**Plug MALC-01TP type (Thread screw mount)**

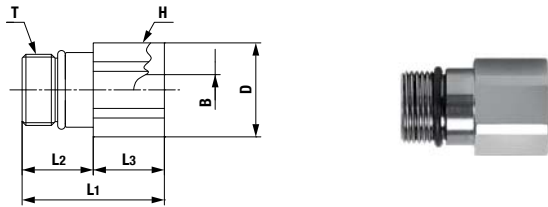

Model	Application	Mass (g)	Dimensions (mm)						
			L1	L2	L3	øD	øB	H(WAF)	T
MALC-01TP	See drawings below.	40	28	(14)	14	18.5	6	Hex.17	M14 x 1

**Socket MALC-01S type (Thread screw mount)**

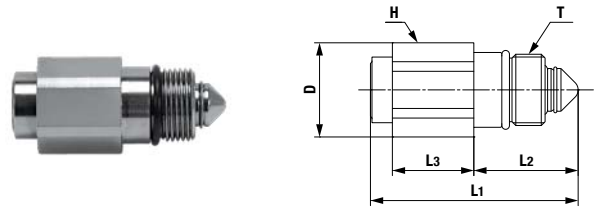

Model	Application	Mass (g)	Dimensions (mm)					T
			L1	L2	L3	øD	H(WAF)	
MALC-01S	See drawings below.	39	(41)	(20.5)	16	18.5	Hex.17	M14 x 1

**Plug MALC-01TP-FL type (With flange)**

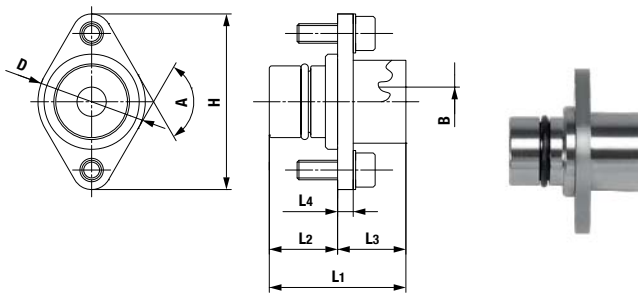

Model	Application	Mass (g)	Dimensions (mm)							
			L1	L2	L3	L4	øD	A	øB	H
MALC-01TP-FL	See drawings below.	52	28	(14)	14	3.2	(22)	120°	6	36

**Socket MALC-01S-FL type (With flange)**

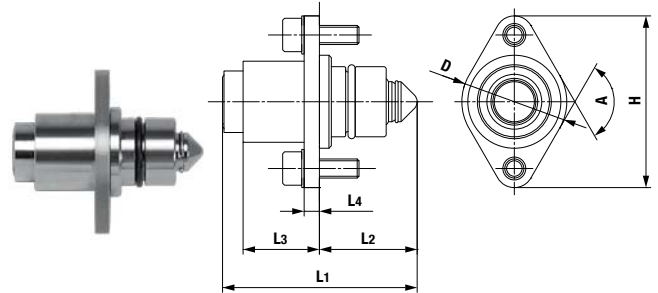

Model	Application	Mass (g)	Dimensions (mm)						H
			L1	L2	L3	L4	øD	A	
MALC-01S-FL	See drawings below.	51	(41)	(20.5)	16	3.2	(22)	120°	36

Dimensions of End Configurations

**MALC-01TP / 01S type (Thread screw mount)**

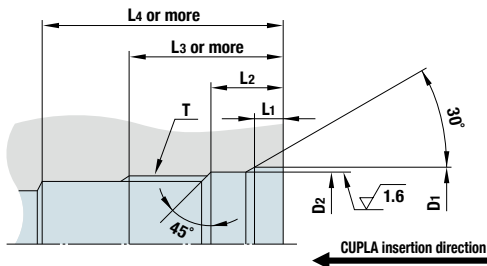

Model	Dimensions (mm)						
	øD1	øD2	L1	L2	L3	L4	T
MALC-01S	15.8 <sup>+0.05</sup> <sub>0</sub>	14.8 <sup>+0.05</sup> <sub>0</sub>	3	7.5 <sup>+0.2</sup> <sub>0</sub>	16	25	M14 x 1
MALC-01TP						18	

**MALC-01TP-FL / 01S-FL type (With flange)**

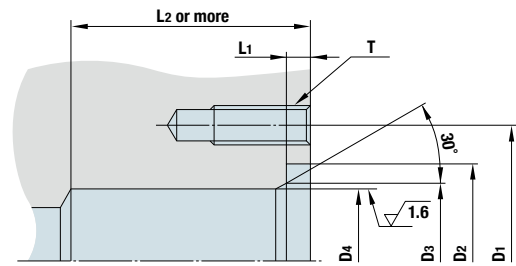

Model	Dimensions (mm)						
	D1	øD2	øD3	øD4	L1	L2	T
MALC-01S-FL				14.8 <sup>+0.05</sup> <sub>0</sub>	2.5 <sup>+0.1</sup> <sub>0</sub>	25	2 x M4 x 0.7
MALC-01TP-FL	PCD28	20	16			16	Thread depth 10 mm or more

*Solo use of socket is possible*

*The shape of counterpart for solo use of socket*

*The shape of counterpart for connection*

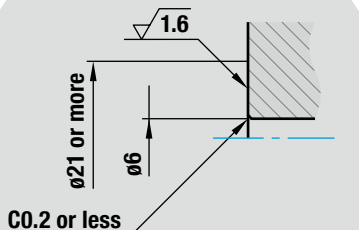

The angle of inclination between the socket and counterpart must be within 0.5 degrees.

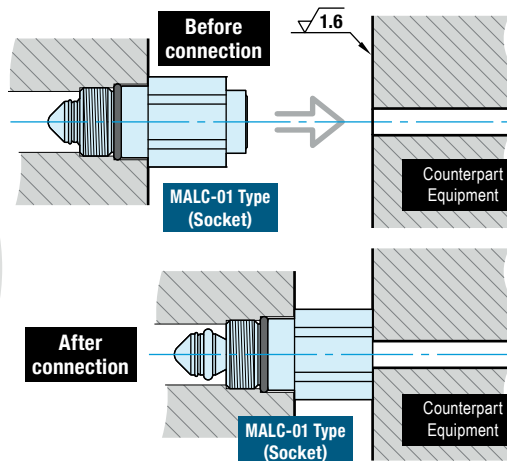

Distance between plates is 16 mm for solo use of socket.

As in the case of MULTI CUPLA MALC-SP type and MALC-HSP type, the distance between the socket plate and the plug plate is designed to be 30 mm when connected. This means the MULTI CUPLA MALC-01 type can also be installed mixed with any size of MALC-SP type and MALC-HSP type on the same plate.

A 2 mm axial eccentricity allowance.

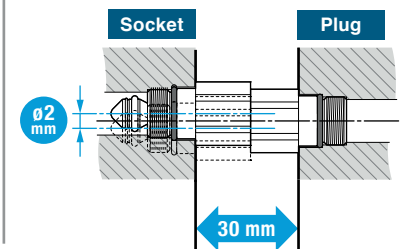

For Multi-Port Connection (Automatic)

# MULTI CUPLA

**MALC-SP Type** for Medium Pressure Use

Low spill type for medium pressure use

Working pressure



1.5 to 7.0 MPa  
(15 to 71 kgf/cm<sup>2</sup>)

Valve structure



Two-way shut-off  
(Non-Spill)

Applicable fluids



Water

Hydraulic oil

Air

A single operation enables simultaneous connections of multiple lines. A special design for medium pressure use minimizes air admixture in fluid lines upon connection.

- Compared with conventional MULTI CUPLA, approximately double flow rates are realized. This could reduce the size of required plates. (Rate of flow increase depends on CUPLA sizes.)
- The MALC type realizes a 2 mm axial eccentricity allowance, while the conventional MULTI CUPLA is only 0.6 mm.
- Special valve design enables connection of socket and plug under pressure of up to 2 MPa. (up to 1.5 MPa for MALC-12SP.)
- When connected, the distance between the socket plate and the plug plate is designed to be 30 mm for all sizes. This means that any size of CUPLA can be mounted and used on the same plate.
- Low spill valves minimize outflow of fluid and admixture of air into the fluid line.



## Specifications

Body material		Stainless steel (Socket body: Nickel plated)		
Model	Thread screw mount	MALC-1SP	MALC-2 to 8SP	MALC-12SP
	Flange	—	MALC-2 to 8SP-FL	—
	Snap ring	—	MALC-8SP-10F	MALC-12SP(-F/-16F)
Working pressure *	MPa	7.0 (2.0)	5.0 (2.0)	1.5 (1.5)
	kgf/cm <sup>2</sup>	71 (20)	51 (20)	15 (15)
	bar	70 (20)	50 (20)	15 (15)
	PSI	1020 (290)	725 (290)	218 (218)
Seal material		Sealing material	Mark	Working temperature range
Working temperature range		Fluoro rubber	FKM (X-100)	-20°C to +180°C

\* The value in brackets is Maximum working pressure of individual plug or socket.

## Maximum Tightening Torque

Model	1SP	2SP	3SP	4SP	6SP	8SP	12SP	12SP-16F
Thread screw mount	20 {204}	30 {306}	35 {357}	45 {460}	60 {612}	75 {765}	80 {816}	—
Flange	—	7 {71.5}	7 {71.5}	7 {71.5}	7 {71.5}	23 {235}	—	—
Snap ring	—	—	—	—	—	260 {2652}	280 {2856}	350 {3570}

## Interchangeability

Socket and plug in the same size can be connected regardless of their end configurations.

## Minimum Cross-Sectional Area

Model	1SP	2SP(-FL)	3SP(-FL)	4SP(-FL)	6SP(-FL)	8SP(-FL/-10F)	12SP(-F/-16F)
Min. cross-sectional area	26	49.5	87	153	227	347	795

## Suitability for Vacuum

Not suitable for vacuum application in either connected or disconnected condition.

## Admixture of Air on Connection

Model	1SP	2SP(-FL)	3SP(-FL)	4SP(-FL)	6SP(-FL)	8SP(-FL/-10F)	12SP(-F/-16F)
Volume of air	0.08	0.14	0.26	0.55	0.95	0.85	1.46

## Volume of Spillage per Disconnection

Model	1SP	2SP(-FL)	3SP(-FL)	4SP(-FL)	6SP(-FL)	8SP(-FL/-10F)	12SP(-F/-16F)
Volume of spillage	0.08	0.14	0.26	0.55	0.95	0.85	1.46

## Load Required to Maintain Connection When Line Is Pressurized

Model	1SP	2SP(-FL)	3SP(-FL)	4SP(-FL)	6SP(-FL)	8SP(-FL/-10F)	12SP(-F/-16F)
Maximum acceptable load N (kgf)	2800 {286}	4500 {459}	5600 {571}	10000 {1019}	14000 {1427}	15600 {1591}	8200 {837}
Minimum load required to maintain connection N (kgf) *	$P \times 170 + 85$ { $p \times 1.7 + 8.5$ }	$P \times 345 + 180$ { $p \times 3.45 + 18$ }	$P \times 460 + 190$ { $p \times 4.6 + 19$ }	$P \times 855 + 260$ { $p \times 8.55 + 26$ }	$P \times 1160 + 260$ { $p \times 11.6 + 26$ }	$P \times 1360 + 310$ { $p \times 13.6 + 31$ }	$P \times 2260 + 400$ { $p \times 22.6 + 40$ }

\* Assign the actual value of pressure [P (MPa), p (kgf/cm<sup>2</sup>)] to the above formula to calculate the load. Maintain the connection with the minimum load or more, but not more than the maximum acceptable load.

## Flow Rate - Pressure Loss Characteristics

[Test conditions] • Fluid : Water • Temperature : 19°C to 25°C

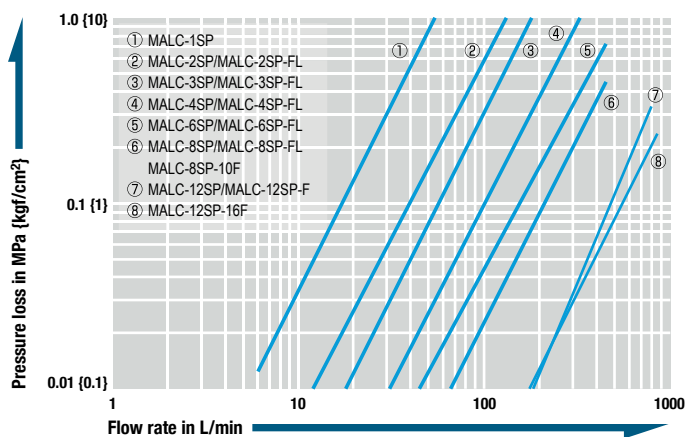

Models and Dimensions

**Plug** MALC-1 to 12P type (Thread screw mount)

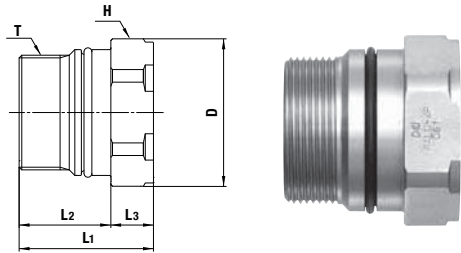

Model	Application	Mass (g)	Dimensions (mm)					
			L1	L2	L3	øD	H(WAF)	T
MALC-1P	See P123	40	32	(18)	14	21	Hex.19	M16 x 1
MALC-2P		75	33	(20)	13	28	Hex.26	M20 x 1.5
MALC-3P		95	33	(20)	13	32	Hex.29	M24 x 1.5
MALC-4P		248	41	(28)	13	45	Hex.41	M35 x 1.5
MALC-6P		369	50.5	(37.5)	13	50	Hex.46	M40 x 2
MALC-8P		399	53	(41)	12	54	Hex.50	M45 x 2
MALC-12P		724	57	(45)	12	74	Hex.67	M62 x 2

**Socket** MALC-1 to 12S type (Thread screw mount)

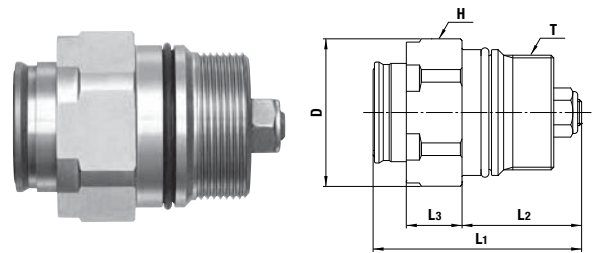

Model	Application	Mass (g)	Dimensions (mm)					
			L1	L2	L3	øD	H(WAF)	T
MALC-1S	See P123	53	(45)	(23)	16	21	Hex.19	M16 x 1
MALC-2S		95	(49)	(26)	17	28	Hex.26	M20 x 1.5
MALC-3S		120	(51)	(26)	17	32	Hex.29	M24 x 1.5
MALC-4S		306	(64)	(36.5)	17	45	Hex.41	M35 x 1.5
MALC-6S		471	(78.5)	(47.5)	17	50	Hex.46	M40 x 2
MALC-8S		590	(86)	(53)	18	54	Hex.50	M45 x 2
MALC-12S		1176	(98)	(60)	18	74	Hex.67	M62 x 2

**Plug** MALC-2 to 6P-FL type (With flange)

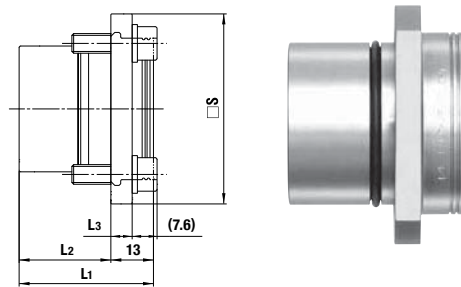

Model	Application	Mass (g)	Dimensions (mm)				□ S
			L1	L2	L3	□ S	
MALC-2P-FL	See P123	146	30	(17)	6	40	
MALC-3P-FL		180	33	(20)	6	45	
MALC-4P-FL		390	41	(28)	6.5	58	
MALC-6P-FL		553	50.5	(37.5)	6.5	64	

**Socket** MALC-2 to 6S-FL type (With flange)

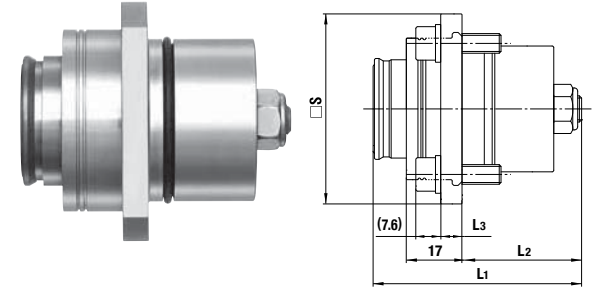

Model	Application	Mass (g)	Dimensions (mm)				□ S
			L1	L2	L3	□ S	
MALC-2S-FL	See P123	173	(49)	(26)	6	40	
MALC-3S-FL		208	(51)	(26)	6	45	
MALC-4S-FL		449	(64)	(36.5)	6.5	58	
MALC-6S-FL		663	(78.5)	(47.5)	6.5	64	

**Plug** MALC-8P-FL type (With flange)

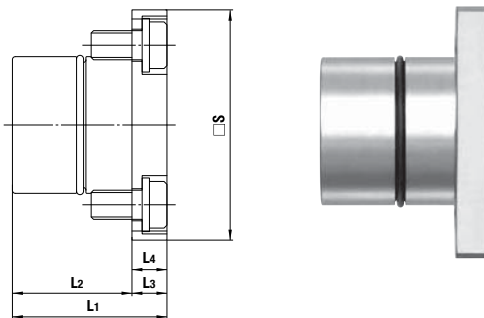

Model	Application	Mass (g)	Dimensions (mm)				□ S
			L1	L2	L3	L4	
MALC-8P-FL	See P123	796	53	(41)	12	12	79

**Socket** MALC-8S-FL type (With flange)

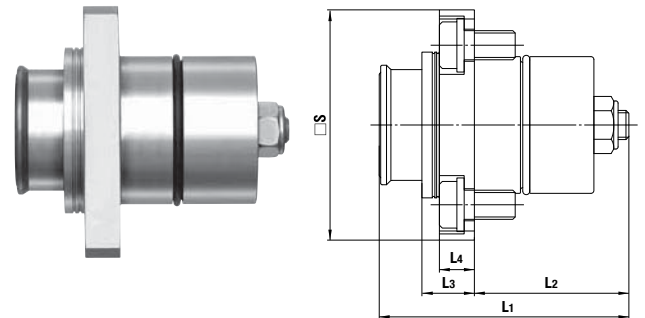

Model	Application	Mass (g)	Dimensions (mm)				□ S
			L1	L2	L3	L4	
MALC-8S-FL	See P123	978	(86)	(53)	18	12	79

Acceptable distance between socket and plug

Plug and socket must be used in contact with each other.  
Maximum 0.5 mm distance between socket and plug is acceptable.

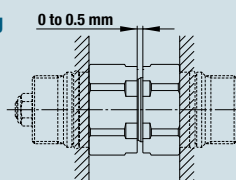



Models and Dimensions

**Plug MALC-8 / 12P type (With snap ring)**

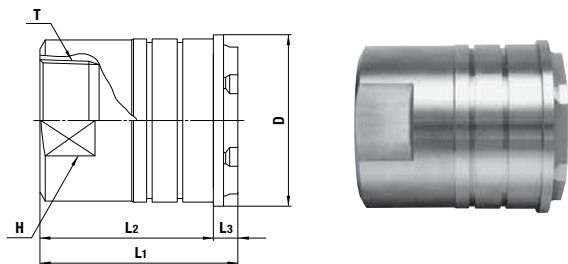

Model	Application	Mass (g)	Dimensions (mm)					
			L1	L2	L3	øD	H(WAF)	T
MALC-8P-10F	See drawings below.	1182	(87)	75	(12)	64	54	Rc 1 1/4
MALC-12P-F		2054	(97)	85	(12)	84	58	Rc 1 1/2
MALC-12P-16F		2128	(97)	85	(12)	84	71	Rc 2

**Socket MALC-8 / 12S type (With snap ring)**

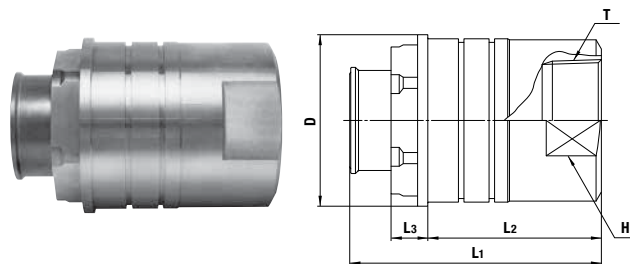

Model	Application	Mass (g)	Dimensions (mm)					
			L1	L2	L3	øD	H(WAF)	T
MALC-8S-10F	See drawings below.	1373	(108)	75	(18)	64	54	Rc 1 1/4
MALC-12S-F		2505	(123)	85	(18)	84	58	Rc 1 1/2
MALC-12S-16F		2579	(123)	85	(18)	84	71	Rc 2

Dimensions of End Configurations

**MALC-1 to 12SP type (Thread screw mount)**

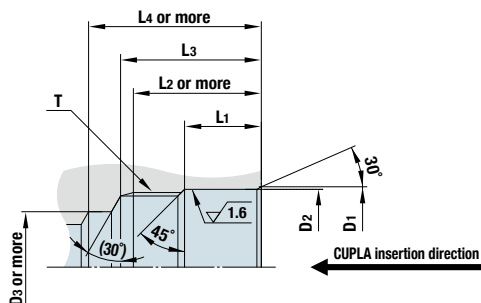

Model	Dimensions (mm)							T
	øD1	øD2	øD3	L1	L2	L3	L4	
MALC-1S	18.3 <sup>+0.1</sup> <sub>0</sub>	17.3 <sup>+0.06</sup> <sub>0</sub>	13	11	20	22	25	M16 x 1
MALC-1P	24 <sup>+0.1</sup> <sub>0</sub>	23 <sup>+0.06</sup> <sub>0</sub>	16	11.5	22	25	28	M20 x 1.5
MALC-2S	27.6 <sup>+0.1</sup> <sub>0</sub>	26.6 <sup>+0.08</sup> <sub>0</sub>	18	11	22	25	29	M24 x 1.5
MALC-2P	39.5 <sup>+0.1</sup> <sub>0</sub>	38.5 <sup>+0.08</sup> <sub>0</sub>	26	15.5	30	33	40.5	M35 x 1.5
MALC-3S	45 <sup>+0.1</sup> <sub>0</sub>	44 <sup>+0.08</sup> <sub>0</sub>	30	20	40	44	51.5	M40 x 2
MALC-3P	48 <sup>+0.3</sup> <sub>0</sub>	47 <sup>+0.08</sup> <sub>0</sub>	35	27	43	47	55	M45 x 2
MALC-4S	66 <sup>+0.3</sup> <sub>0</sub>	64 <sup>+0.1</sup> <sub>0</sub>	45	30	50	54	65	M62 x 2
MALC-4P								
MALC-6S								
MALC-6P								
MALC-8S								
MALC-8P								
MALC-12S								
MALC-12P								

**MALC-2 to 8SP-FL type (With flange)**

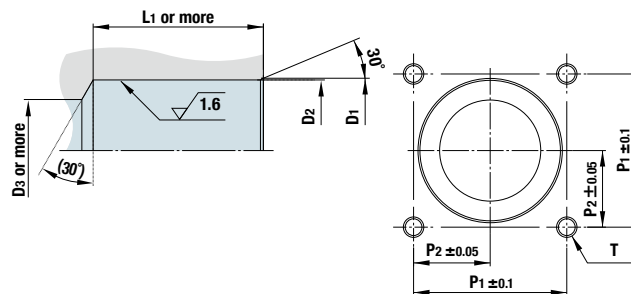

Model	Dimensions (mm)						
	øD1	øD2	øD3	L1	P1	P2	T
MALC-2S-FL	24 <sup>+0.1</sup> <sub>0</sub>	23 <sup>+0.06</sup> <sub>0</sub>	16	28	28	14	4 x M6 Thread depth 17 mm or more
MALC-2P-FL				19			
MALC-3S-FL	27.6 <sup>+0.1</sup> <sub>0</sub>	26.6 <sup>+0.08</sup> <sub>0</sub>	18	28	31	15.5	
MALC-3P-FL				22			
MALC-4S-FL	39.5 <sup>+0.1</sup> <sub>0</sub>	38.5 <sup>+0.08</sup> <sub>0</sub>	26	39	40	20	4 x M10 Thread depth 15 mm or more
MALC-4P-FL				30.5			
MALC-6S-FL	45 <sup>+0.1</sup> <sub>0</sub>	44 <sup>+0.08</sup> <sub>0</sub>	30	50	45	22.5	
MALC-6P-FL				40			
MALC-8S-FL	48 <sup>+0.3</sup> <sub>0</sub>	47 <sup>+0.08</sup> <sub>0</sub>	35	53	55	27.5	
MALC-8P-FL				43			

**MALC-8 / 12P type (With snap ring)**

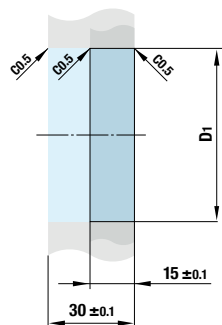
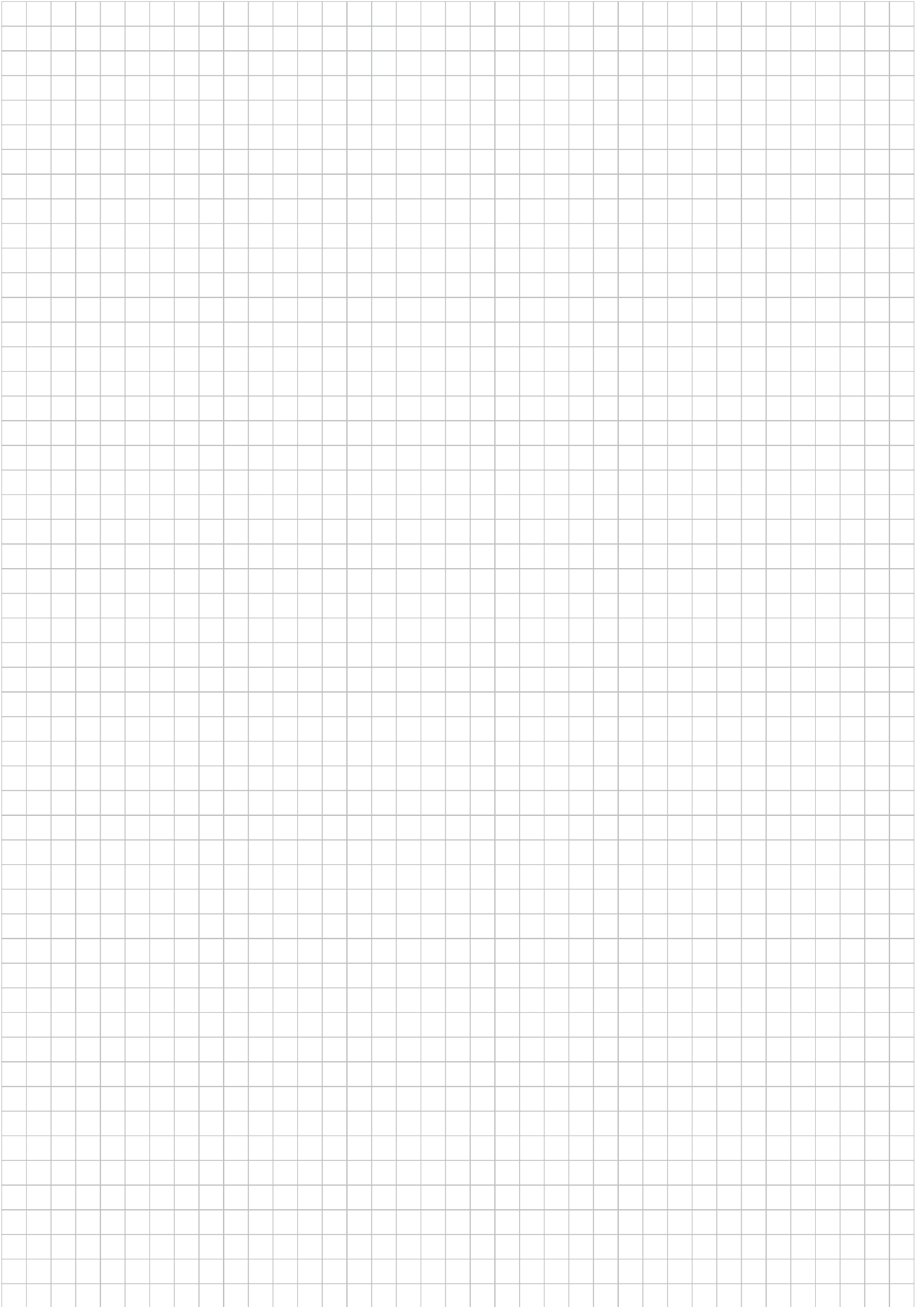

Plate with 15 mm or 30 mm thickness can be mounted.

Model	Dimensions (mm)	
	øD1	
MALC-8S-10F	60.1 <sup>+0.1</sup> <sub>0</sub>	
MALC-8P-10F		
MALC-12S-F	80.1 <sup>+0.1</sup> <sub>0</sub>	
MALC-12P-F		
MALC-12S-16F	80.1 <sup>+0.1</sup> <sub>0</sub>	
MALC-12P-16F		

Before use, please be sure to read "Safety Guide" described at the end of this book and "Instruction Sheet" that comes with the products.



For Multi-Port Connection (Automatic)

# MULTI CUPLA

**MALC-HSP Type** for High Pressure Use

Low spill type for high pressure use

Working pressure



21.0 to 25.0 MPa  
(214 to 255 kgf/cm<sup>2</sup>)

Valve structure



Two-way shut-off

Applicable fluids



Hydraulic oil

A single operation enables simultaneous connections of multiple lines. A special design minimizes air admixture in fluid lines upon connection. Suitable for high pressure hydraulic circuits.

- Compared with conventional MULTI CUPLA, approximately double flow rates are realized. This could reduce the size of required plates. (Rate of flow increase depends on CUPLA sizes.)
- The MALC type realizes a 2 mm axial eccentricity allowance, while the conventional MULTI CUPLA is only 0.6 mm.
- Special valve design enables connection of socket and plug under dynamic pressure of up to 8 MPa.
- When connected, the distance between the socket plate and plug plate is designed to be 30 mm for all sizes. This means any size of CUPLA can be mounted and used on the same plate.
- Low spill valves minimize outflow of fluid and admixture of air into the fluid line.

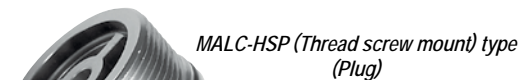

MALC-HSP (Thread screw mount) type (Plug)

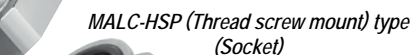

MALC-HSP (Thread screw mount) type (Socket)



MALC-HSP (Flange) type (Plug)

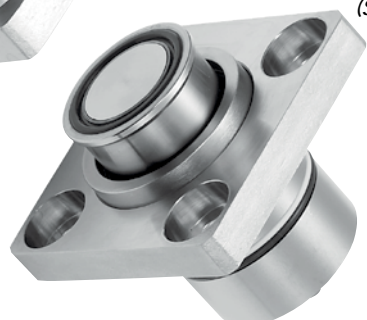

MALC-HSP (Flange) type (Socket)

Specifications			
Body material		Special steel (Nickel plated)	
Model	Thread screw mount	MALC-1HSP	MALC-2 to 8HSP
	Flange	-	MALC-2 to 8HSP-FL
Working pressure *	MPa	25.0 (8.0)	21.0 (8.0)
	kgf/cm <sup>2</sup>	255 (81)	214 (81)
	bar	250 (80)	210 (80)
	PSI	3630 (1160)	3050 (1160)
Seal material		Sealing material	Mark
Working temperature range		Fluoro rubber	FKM (X-100)
		Working temperature range	
		-20 °C to +180 °C	

\* The value in brackets is Maximum working pressure of individual plug or socket.

Maximum Tightening Torque						Nm {kgf·cm}
Model	1HSP	2HSP	3HSP	4HSP	6HSP	8HSP
Thread screw mount	30 {306}	50 {510}	53 {540}	65 {663}	80 {816}	95 {969}
Flange	-	9 {91}				30 {306}

**Interchangeability**  
Socket and plug in the same size can be connected regardless of their end configurations.

Minimum Cross-Sectional Area						(mm <sup>2</sup> )
Model	1HSP	2HSP	3HSP	4HSP	6HSP	8HSP
Min. cross-sectional area	26	49.5	87	153	227	347

**Suitability for Vacuum**  
Not suitable for vacuum application in either connected or disconnected condition.

Admixture of Air on Connection						(mL)
Model	1HSP	2HSP	3HSP	4HSP	6HSP	8HSP
Volume of air	0.08	0.14	0.26	0.55	0.95	0.85

Volume of Spillage per Disconnection						(mL)
Model	1HSP	2HSP	3HSP	4HSP	6HSP	8HSP
Volume of spillage	0.08	0.14	0.26	0.55	0.95	0.85

Load Required to Maintain Connection When Line Is Pressurized						
Model	1HSP	2HSP	3HSP	4HSP	6HSP	8HSP
Maximum acceptable load N (kgf)	9300 {948}	16500 {1683}	22000 {2244}	40500 {4130}	55000 {5609}	64500 {6577}
Minimum load required to maintain connection N (kgf) *	$P \times 170 + 85$ { $p \times 1.7 + 8.5$ }	$P \times 345 + 180$ { $p \times 3.45 + 18$ }	$P \times 460 + 190$ { $p \times 4.6 + 19$ }	$P \times 855 + 260$ { $p \times 8.55 + 26$ }	$P \times 1160 + 260$ { $p \times 11.6 + 26$ }	$P \times 1360 + 310$ { $p \times 13.6 + 31$ }

\* Assign the actual value of pressure [P (MPa), p (kgf/cm<sup>2</sup>)] to the above formula to calculate the load. Maintain the connection with the minimum load or more, but not more than the maximum acceptable load.

### Flow Rate - Pressure Loss Characteristics

[Test conditions] • Fluid : Hydraulic oil • Temperature : 30 °C±5 °C  
• Fluid viscosity : 32 x 10<sup>-6</sup> m<sup>2</sup>/s • Density : 0.87 x 10<sup>3</sup> kg/m<sup>3</sup>

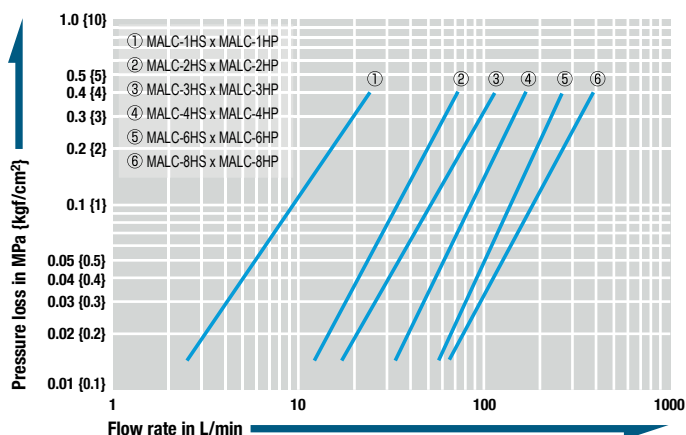

Models and Dimensions

**Plug MALC-1 to 8HP type (Thread screw mount)**

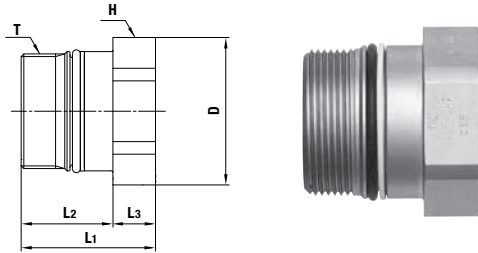

Model	Application	Mass (g)	Dimensions (mm)					
			L1	L2	L3	øD	H(WAF)	T
MALC-1HP	See P127	39	32	(18)	14	21	Hex.19	M16 x 1
MALC-2HP		73	33	(20)	13	28	Hex.26	M20 x 1.5
MALC-3HP		96	33	(20)	13	32	Hex.29	M24 x 1.5
MALC-4HP		250	41	(28)	13	45	Hex.41	M35 x 1.5
MALC-6HP		357	50.5	(37.5)	13	50	Hex.46	M40 x 2
MALC-8HP		391	53	(41)	12	54	Hex.50	M45 x 2

**Socket MALC-1 to 8HS type (Thread screw mount)**

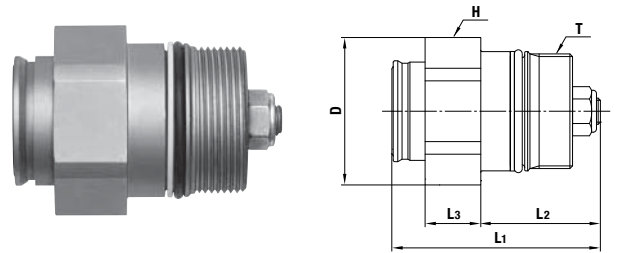

Model	Application	Mass (g)	Dimensions (mm)					
			L1	L2	L3	øD	H(WAF)	T
MALC-1HS	See P127	51	(45)	(23)	16	21	Hex.19	M16 x 1
MALC-2HS		89	(49)	(26)	17	28	Hex.26	M20 x 1.5
MALC-3HS		117	(51)	(26)	17	32	Hex.29	M24 x 1.5
MALC-4HS		290	(64)	(36.5)	17	45	Hex.41	M35 x 1.5
MALC-6HS		447	(78.5)	(47.5)	17	50	Hex.46	M40 x 2
MALC-8HS		579	(86)	(53)	18	54	Hex.50	M45 x 2

**Plug MALC-2 to 6HP-FL type (With flange)**

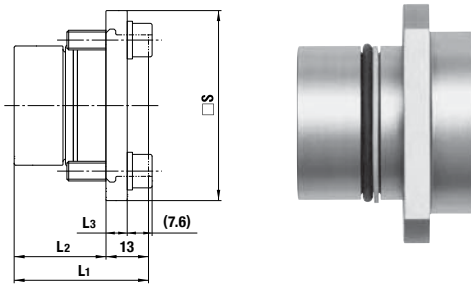

Model	Application	Mass (g)	Dimensions (mm)			
			L1	L2	L3	□ S
MALC-2HP-FL	See P127	142	30	(17)	6	40
MALC-3HP-FL		179	33	(20)	6	45
MALC-4HP-FL		367	41	(28)	6.5	58
MALC-6HP-FL		514	50.5	(37.5)	6.5	64

**Socket MALC-2 to 6HS-FL type (With flange)**

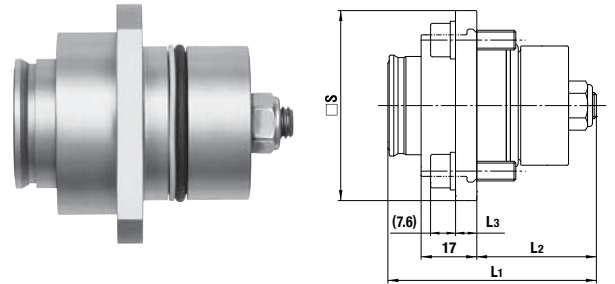

Model	Application	Mass (g)	Dimensions (mm)			
			L1	L2	L3	□ S
MALC-2HS-FL	See P127	163	(49)	(26)	6	40
MALC-3HS-FL		200	(51)	(26)	6	45
MALC-4HS-FL		418	(64)	(36.5)	6.5	58
MALC-6HS-FL		611	(78.5)	(47.5)	6.5	64

**Plug MALC-8HP-FL type (With flange)**

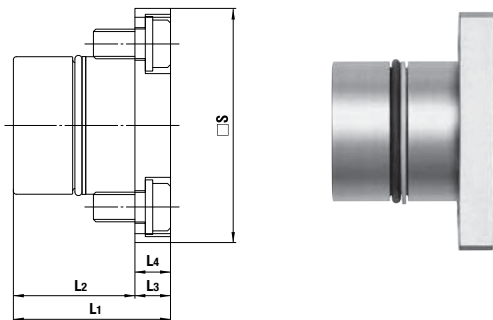

Model	Application	Mass (g)	Dimensions (mm)				
			L1	L2	L3	L4	□ S
MALC-8HP-FL	See P127	786	53	(41)	12	12	79

**Socket MALC-8HS-FL type (With flange)**

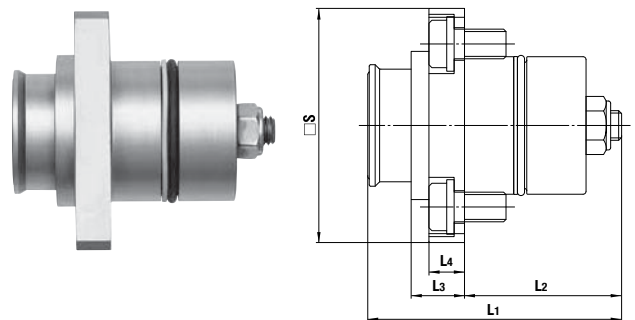

Model	Application	Mass (g)	Dimensions (mm)				
			L1	L2	L3	L4	□ S
MALC-8HS-FL	See P127	964	(86)	(53)	18	12	79

**Acceptable distance between Socket and Plug**

Plug and socket must be used in contact with each other.  
Maximum 0.5 mm distance between socket and plug is acceptable.

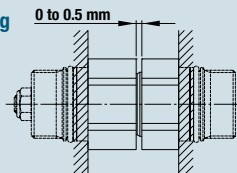



Dimensions of End Configurations

MALC-1 to 8HSP type (Thread screw mount)

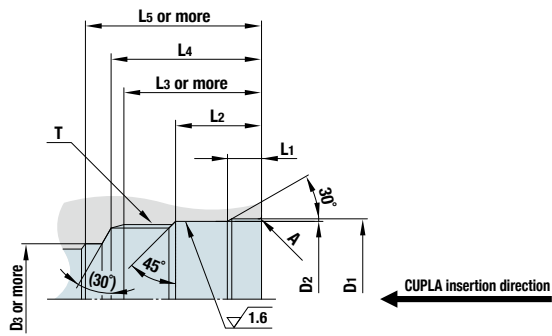

Model	Dimensions (mm)									
	øD <sub>1</sub>	øD <sub>2</sub>	øD <sub>3</sub>	L <sub>1</sub>	L <sub>2</sub>	L <sub>3</sub>	L <sub>4</sub>	L <sub>5</sub>	T	A
MALC-1HS	17.8 <sup>+0.1</sup> <sub>0</sub>	16.8 <sup>+0.06</sup> <sub>0</sub>	13	3.5 <sup>+0.2</sup> <sub>0</sub>	11	20	22	25	M16 x 1	C0.2
MALC-1HP										
MALC-2HS	23 <sup>+0.1</sup> <sub>0</sub>	22 <sup>+0.06</sup> <sub>0</sub>	16	2.8 <sup>+0.2</sup> <sub>0</sub>	11	22	25	28	M20 x 1.5	R0.5
MALC-2HP										
MALC-3HS	27.1 <sup>+0.1</sup> <sub>0</sub>	26 <sup>+0.08</sup> <sub>0</sub>	18	2.8 <sup>+0.2</sup> <sub>0</sub>	11	22	25	29	M24 x 1.5	R0.5
MALC-3HP										
MALC-4HS	37.7 <sup>+0.3</sup> <sub>0</sub>	36.5 <sup>+0.08</sup> <sub>0</sub>	26	6 <sup>+0.2</sup>	18	30	33	40.5	M35 x 1.5	R0.5
MALC-4HP										
MALC-6HS	42.5 <sup>+0.3</sup> <sub>0</sub>	41.5 <sup>+0.08</sup> <sub>0</sub>	30	6 <sup>+0.2</sup>	23	40	44	51.5	M40 x 2	R0.5
MALC-6HP										
MALC-8HS	47.5 <sup>+0.3</sup> <sub>0</sub>	46.5 <sup>+0.08</sup> <sub>0</sub>	35	10.5 <sup>+0.2</sup>	27	43	47	55	M45 x 2	R0.5
MALC-8HP										

MALC-2 to 8HSP-FL type (With flange)

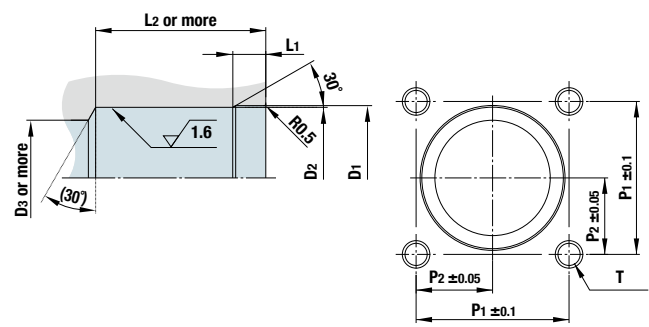

Model	Dimensions (mm)							
	øD <sub>1</sub>	øD <sub>2</sub>	øD <sub>3</sub>	L <sub>1</sub>	L <sub>2</sub>	P <sub>1</sub>	P <sub>2</sub>	T
MALC-2HS-FL	23 <sup>+0.1</sup> <sub>0</sub>	22 <sup>+0.06</sup> <sub>0</sub>	16	2.8 <sup>+0.2</sup> <sub>0</sub>	28	28	14	4 x M6 Thread depth 17 mm or more
MALC-2HP-FL					19			
MALC-3HS-FL	27.1 <sup>+0.1</sup> <sub>0</sub>	26 <sup>+0.08</sup> <sub>0</sub>	18	2.8 <sup>+0.2</sup> <sub>0</sub>	28	31	15.5	
MALC-3HP-FL					22			
MALC-4HS-FL	37.7 <sup>+0.3</sup> <sub>0</sub>	36.5 <sup>+0.08</sup> <sub>0</sub>	26	6 <sup>+0.2</sup>	39	40	20	4 x M10 Thread depth 15 mm or more
MALC-4HP-FL					30.5			
MALC-6HS-FL	42.5 <sup>+0.3</sup> <sub>0</sub>	41.5 <sup>+0.08</sup> <sub>0</sub>	30	6 <sup>+0.2</sup>	50	45	22.5	
MALC-6HP-FL					40			
MALC-8HS-FL	47.5 <sup>+0.3</sup> <sub>0</sub>	46.5 <sup>+0.08</sup> <sub>0</sub>	35	10.5 <sup>+0.2</sup>	53	55	27.5	
MALC-8HP-FL					43			

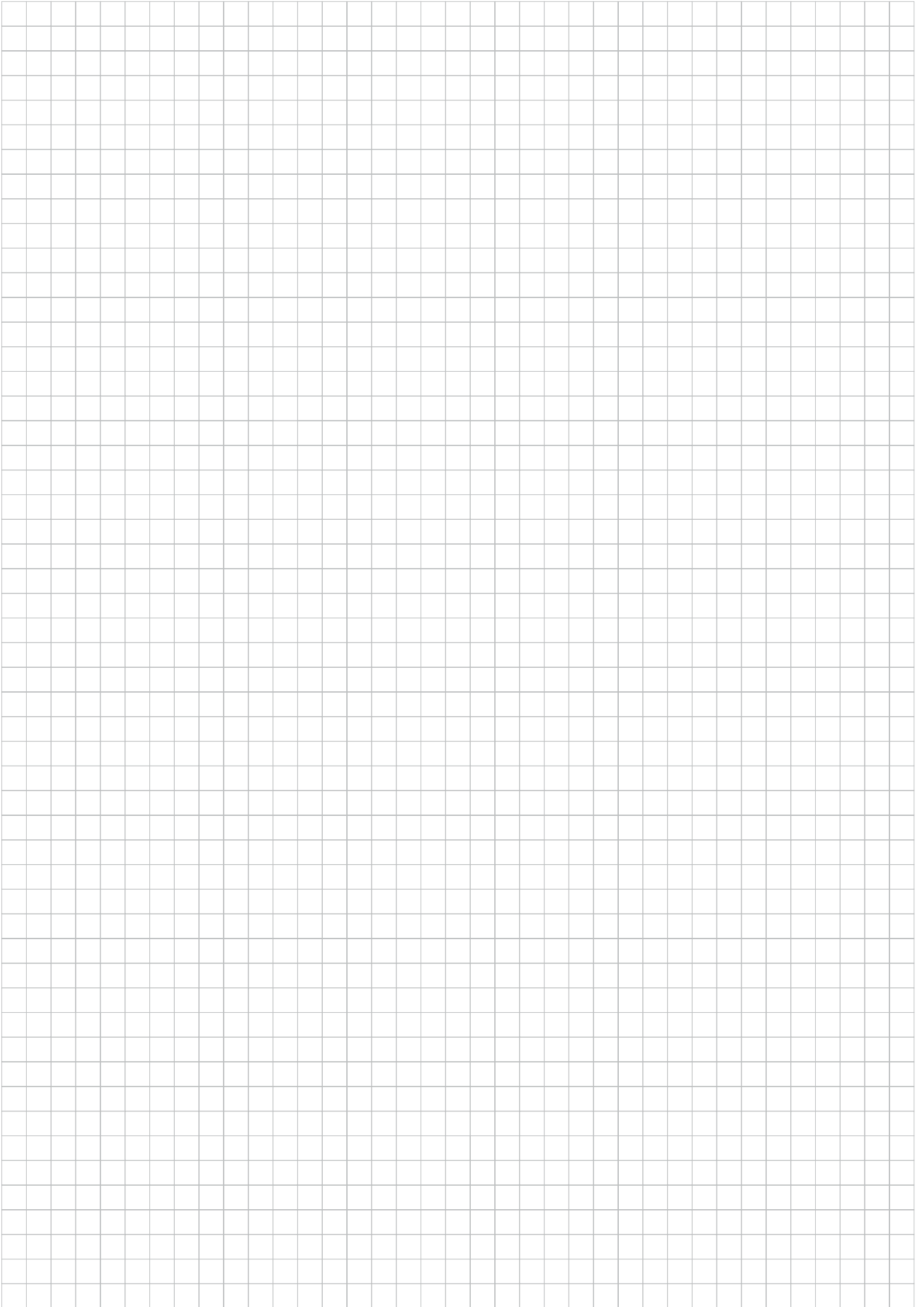



For High Purity Chemicals

# SEMICON CUPLA

## SP Type

For semiconductor manufacturing production installation

<b>Working pressure</b>  0.2 MPa (2 kgf/cm <sup>2</sup> )	<b>Valve structure</b>  Two-way shut-off	<b>Applicable fluids</b>  High purity chemicals Water Gas Air
--	---	---

General purpose type with stainless steel body and rubber seal.  
Electro-polished body for enhanced corrosion resistance.

- Body and valve springs are stainless steel (SUS304). Body is electro-polished for enhanced corrosion resistance.
- Seal materials can be selected to suit your fluid and application, to flexibly comply with your semiconductor production process requirements.
- All components are cleaned, assembled, inspected, and then packed in a clean room.
- Grease free. No grease is applied to the seal material.
- Each plug comes with a dust cap.
- Stainless steel SUS316 body and valve springs are available as made-to-order products.



Specifications				
Body material	Electropolished stainless steel (SUS304)			
Size (Thread)	1/8", 1/4", 3/8", 1/2", 3/4", 1" 1/8-27NPT, 1/4-18NPT, 19/32-18UNS			
Pressure unit	MPa	kgf/cm <sup>2</sup>	bar	PSI
Working pressure	0.2	2	2	29
Seal material Working temperature range	Seal material	Mark	Working temperature range	Remarks
	Fluoro rubber	FKM (X-100)	0°C to +50°C	Standard material
	Ethylene-propylene rubber	EPDM (EPTS)	0°C to +50°C	Standard material
	Perfluoroelastomer	P	0°C to +50°C	Standard material
	Kalrez	KL	0°C to +50°C	Standard material

Maximum Tightening Torque Nm {kgf·cm}							
Size	1/8-27NPT Rc 1/8	1/4-18NPT Rc 1/4	19/32-18UNS	Rc 3/8	Rc 1/2	Rc 3/4	Rc 1
Torque	9 {92}	14 {143}	20 {204}	22 {224}	60 {612}	90 {918}	120 {1224}

**Interchangeability**  
Sockets and plugs can be connected regardless of end configurations if the first number in the model name is the same.

Minimum Cross-Sectional Area (mm <sup>2</sup> )						
Model	1SP	2SP	3SP	4SP	6SP	8SP
Min. cross-sectional area	13	17	48	64	83	192

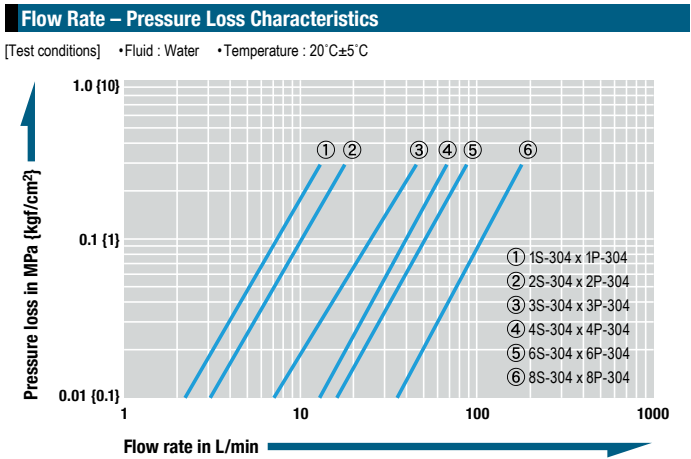

### Models and Dimensions

Model	Container capacity	Mass (g)	Dimensions (mm)			
			L	C	H(WAF)	T
1P-304	For 10L to 20L	19	29	19	Hex.14	Rc 1/8
1P-304-NPT	For 10L to 20L					1/8-27NPT
1P-304-UNS	For 10L to 20L	34	33	19	Hex.21	19/32-18UNS
2P-304	For 10L to 20L					Rc 1/4
2P-304-NPT	For 10L to 20L	35	36	22	Hex.17	1/4-18NPT
2P-304-UNS	For 10L to 20L	41	36	22	Hex.21	19/32-18UNS
3P-304	For 100L to 200L	60	40	25	Hex.21	Rc 3/8
4P-304	For 100L to 200L	115	44	28	Hex.29	Rc 1/2
6P-304	For 100L to 200L	216	52	36	Hex.35	Rc 3/4
8P-304	For 100L to 200L	352	62	40	Hex.41	Rc 1

\* Above are the dimensions of SUS304.  
\* The appearance of SUS304 and 316 bodies is different.

WAF : WAF stands for width across flats.

Model	Container capacity	Mass (g)	Dimensions (mm)			
			L	øD	H(WAF)	T
1S-304	For 10L to 20L	82	48	24	14	Rc 1/8
1S-304-NPT	For 10L to 20L	84				1/8-27NPT
2S-304	For 10L to 20L	138	58	28	19	Rc 1/4
2S-304-NPT	For 10L to 20L					1/4-18NPT
3S-304	For 100L to 200L	204	65	35	21	Rc 3/8
4S-304	For 100L to 200L	424	72	45	29	Rc 1/2
6S-304	For 100L to 200L	708	88	55	35	Rc 3/4
8S-304	For 100L to 200L	1081	102	65	41	Rc 1







Before use, please be sure to read "Safety Guide" described at the end of this book and "Instruction Sheet" that comes with the products.

For High Purity Chemicals

# SEMICON CUPLA

## SCS Type

For semiconductor manufacturing equipment

<b>Working pressure</b>	<b>Valve structure</b>	<b>Applicable fluids</b>			
 0.2 MPa {2 kgf/cm <sup>2</sup> }	 Two-way shut-off	 High purity chemicals	 Water	 Gas	 Air

## Adopted stainless steel body and fluorine contained resin valves.

- The body and spring material of stainless steel (SUS304), and valve of fluorine contained resin ensure excellent performance with various chemicals.
- Body (SUS304) is electropolished for enhanced corrosion resistance.
- All components are cleaned, assembled, inspected, and then packed in a clean room.
- Grease free. Grease is not applied to the seal material.
- Plug comes with a dust cap.

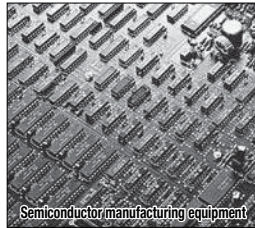

### Specifications

Body material	Electropolished stainless steel (SUS304)			
Size (Thread)	1/8", 1/4", 3/8", 1/2", 3/4", 1" 1/8-27NPT, 1/4-18NPT, 19/32-18UNS			
Pressure unit	MPa	kgf/cm <sup>2</sup>	bar	PSI
Working pressure	0.2	2	2	29
Seal material	Socket	Seal material	Mark	Working temperature range
	O-ring	Perfluoroelastomer	P	0°C to +50°C
Working temperature range	Valve	Fluoropolymer resin (Socket: PFA, Plug: PTFE except 1P and 2P of PFA)		

\*If you need a seal material other than perfluoroelastomer, please consult with us.

### Maximum Tightening Torque

Size	Nm {kgf·cm}						
	1/8-27NPT Rc 1/8	1/4-18NPT Rc 1/4	19/32-18UNS	Rc 3/8	Rc 1/2	Rc 3/4	Rc 1
Torque	9 {92}	14 {143}	20 {204}	22 {224}	60 {612}	90 {918}	120 {1224}

### Interchangeability

Sockets and plugs can be connected regardless of end configurations if the number □ in the model name (SCS-□S (P)) is the same.

The plugs can be connected with sockets of SCY Type of the same size. See below chart for details.

### Interchangeability Check List (SCS Type, SCY Type)

● indicates connection capability except for made-to-order products.

Plug	SCS Type	Model	Socket								
			SCS Type				SCY Type				
			-1S	-2S	-1S	-2S	-3S	-4S	-6S	-8S	
		-1P	●		●						
		-2P		●		●					
		-3P					●				
		-4P						●			
		-6P							●		
		-8P								●	

### Minimum Cross-Sectional Area

Model	SCS-1SP	SCS-2SP	SCS-3P	SCS-4P	SCS-6P	SCS-8P
Min. cross-sectional area	15	23	28	71	110	162

### Flow Rate – Pressure Loss Characteristics

[Test conditions] • Fluid : Water • Temperature : 21°C to 32°C

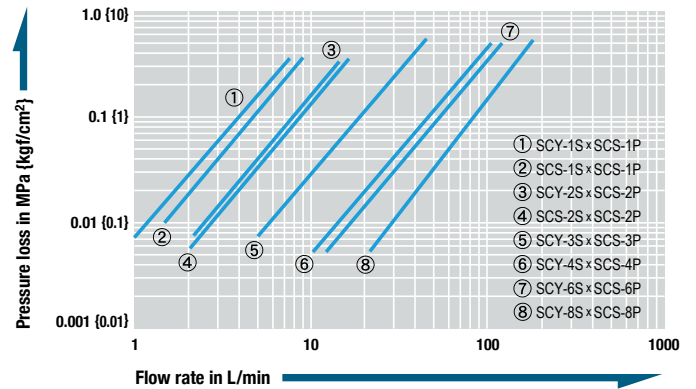

### Models and Dimensions

WAF : WAF stands for width across flats.

#### Plug Female thread

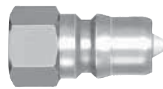
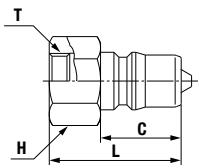

Model	Container capacity	Mass (g)	Dimensions (mm)			
			L	C	H(WAF)	T
SCS-1P	For 10L to 20L	17	29	19	Hex.14	Rc 1/8
SCS-1P-NPT	For 10L to 20L					1/8-27NPT
SCS-1P-UNS	For 10L to 20L	34	33	19	Hex.21	19/32-18UNS
SCS-2P	For 10L to 20L	32	34	22	Hex.17	Rc 1/4
SCS-2P-NPT	For 10L to 20L	29				1/4-18NPT
SCS-2P-UNS	For 10L to 20L	41	36	22	Hex.21	19/32-18UNS
SCS-3P	For 100L to 200L	61	40	25	Hex.21	Rc 3/8
SCS-4P	For 100L to 200L	114	44	28	Hex.29	Rc 1/2
SCS-6P	For 100L to 200L	198	52	36	Hex.35	Rc 3/4
SCS-8P	For 100L to 200L	338	62	40	Hex.41	Rc 1

#### Socket Female thread

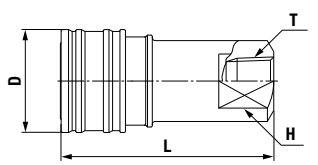

Model	Container capacity	Mass (g)	Dimensions (mm)			
			L	øD	H(WAF)	T
SCS-1S-NPT	For 10L to 20L	84	48	24	14	1/8-27NPT
SCS-2S-NPT	For 10L to 20L	138	58	28	19	1/4-18NPT

Before use, please be sure to read "Safety Guide" described at the end of this book and "Instruction Sheet" that comes with the products.









For High Purity Chemicals

# SEMICON CUPLA

## SCY Type

For semiconductor manufacturing equipment

<b>Working pressure</b>	<b>Valve structure</b>	<b>Applicable fluids</b>			
 0.2 MPa (2 kgf/cm <sup>2</sup> )	 Two-way shut-off	 High purity chemicals	 Water	 Gas	 Air

## Fluorine contained resin packing seal and perfluoroelastomer packing seal are used to reduce required connection load and to achieve tight sealing.

- The material of body and spring are of stainless steel (SUS304), while that of valve is of fluorine contained resin. The combination shows excellent performance with various types of chemicals.
- Body (SUS304) is electropolished for enhanced corrosion resistance.
- All components are cleaned, assembled, inspected, and then packed in a clean room.
- Grease free. Grease is not applied to the seal materials.
- Flanged body makes it easy to operate even with gloves.

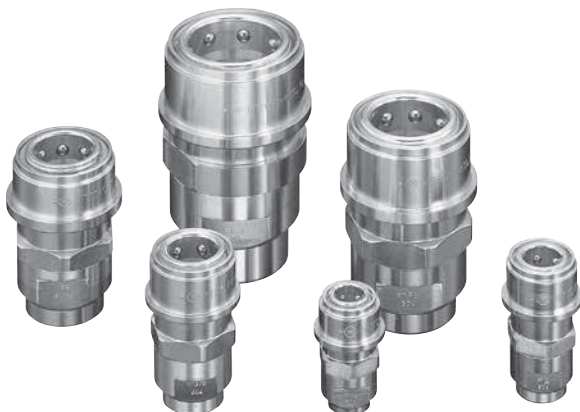

Specifications					
Body material	Electropolished stainless steel (SUS304)				
Size (Thread)	1/8", 1/4", 3/8", 1/2", 3/4", 1" 1/8-27NPT, 1/4-18NPT				
Pressure unit	MPa	kgf/cm <sup>2</sup>	bar	PSI	
Working pressure	0.2	2	2	29	
Seal material Working temperature range	Socket packing seal	Seal material	Mark	Working temperature range	Remarks
		Perfluoroelastomer Fluoropolymer resin	P PTFE (TF)		
	Valve	Fluoropolymer resin (PTFE except 1P and 2P of PFA)			

\*If you need a seal material other than perfluoroelastomer, please consult with us.

### Maximum Tightening Torque Nm {kgf·cm}

See page 130 of SEMICON CUPLA SCS Type.

### Interchangeability

Can be connected with plugs of SCS Type of the same size. See below chart for details.

### Interchangeability Check List (SCS Type, SCY Type)

● indicates connection capability except for made-to-order products.

Plug	SCS Type	Model	SCS Type		Socket						
			-1S	-2S	SCY Type						
			-1S	-2S	-3S	-4S	-6S	-8S			
		-1P	●		●						
		-2P		●		●					
		-3P					●				
		-4P						●			
		-6P								●	
		-8P									●

### Minimum Cross-Sectional Area (mm<sup>2</sup>)

Model	SCY-1S	SCY-2S	SCY-3S	SCY-4S	SCY-6S	SCY-8S
Min. cross-sectional area	15	23	28	71	110	162

### Flow Rate – Pressure Loss Characteristics

[Test conditions] • Fluid : Water • Temperature : 20°C±5°C

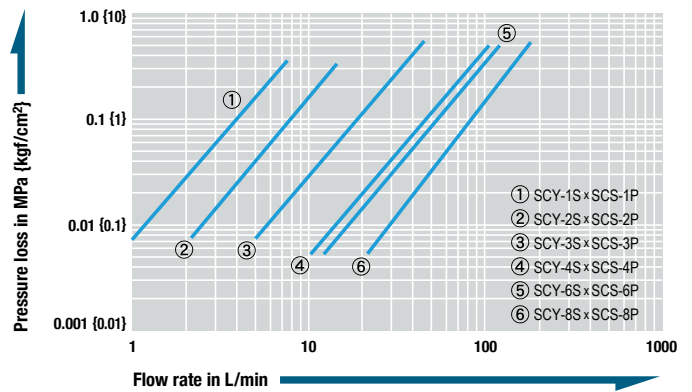

### Models and Dimensions

WAF : WAF stands for width across flats.

### Socket Female thread

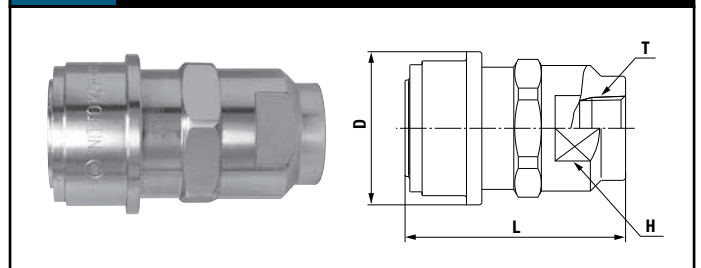

Model	Container capacity	Mass (g)	Dimensions (mm)			
			L	øD	H(WAF)	T
SCY-1S	For 10L to 20L	116	(48)	29	18	Rc 1/8
SCY-1S-NPT	For 10L to 20L					1/8-27NPT
SCY-2S	For 10L to 20L	180	(58)	33	22	Rc 1/4
SCY-2S-NPT	For 10L to 20L					1/4-18NPT
SCY-3S	For 100L to 200L	292	(65)	39	27	Rc 3/8
SCY-4S	For 100L to 200L	519	(72)	50	35	Rc 1/2
SCY-6S	For 100L to 200L	862	(88)	59	41	Rc 3/4
SCY-8S	For 100L to 200L	1360	(102)	68	50	Rc 1



Before use, please be sure to read "Safety Guide" described at the end of this book and "Instruction Sheet" that comes with the products.

For High Purity Chemicals

# SEMICON CUPLA

## SCT Type

For semiconductor manufacturing equipment

Working pressure  0.2 MPa (2 kgf/cm <sup>2</sup> )	Valve structure  Two-way shut-off	Applicable fluids  High purity chemicals Water Gas Air
--	--	--

## Polytetrafluoroethylene (PTFE) is utilised for the body.

- Polytetrafluoroethylene (PTFE) body gives excellent resistance to chemicals.
- Both socket and plug have built-in automatic shut-off valves that prevent fluid from outflowing when disconnected.
- No dissolution of metal ions from part in contact with liquid ensures excellent reliability.
- All components are cleaned, assembled, inspected and then packed in a clean room.
- Appropriate model can be selected from a wide variety of sizes to suit your application / fluid.
- Optional keyway lock to prevent incorrect connection. 10 keyway patterns are available.



Specifications				
Body material	Polytetrafluoroethylene (PTFE)			
Size (Thread)	1/4", 3/8", 1/2", 3/4", 1" 1/4-18NPT, 3/8-18NPT, 1/2-14NPT, 3/4-14NPT, 1-11.5NPT			
Pressure unit	MPa	kgf/cm <sup>2</sup>	bar	PSI
Working pressure	0.2	2	2	29
Seal material	Socket	Seal material	Mark	Working temperature range
Working temperature range	0-ring	FEP-covered fluoro rubber	—	+5°C to +50°C
	Valve	Fluoropolymer resin (PFA)		

### Maximum Tightening amount (approximate)

With seal tape wrapped on the male thread, screw it firmly by hand, and then add more tightening with a wrench as shown below.

1 3/4 to 2 turns	1/4" · 3/8" · 1/2" · 3/4" · 1" Size
------------------	-------------------------------------

Whichever method, overtightening may damage the thread and cause leakage, so take extra care.

### Interchangeability

Sockets and plugs can be connected regardless of end configurations if the number □ in the model name {SCT-□S (P)} is the same.

### Minimum Cross-Sectional Area (mm<sup>2</sup>)

Model	SCT-2SP	SCT-3SP	SCT-4SP	SCT-6SP	SCT-8SP
Minimum cross-sectional area	12	34	54	103	225

### Flow Rate – Pressure Loss Characteristics

[Test conditions] • Fluid : Water • Temperature : 23°C±3°C

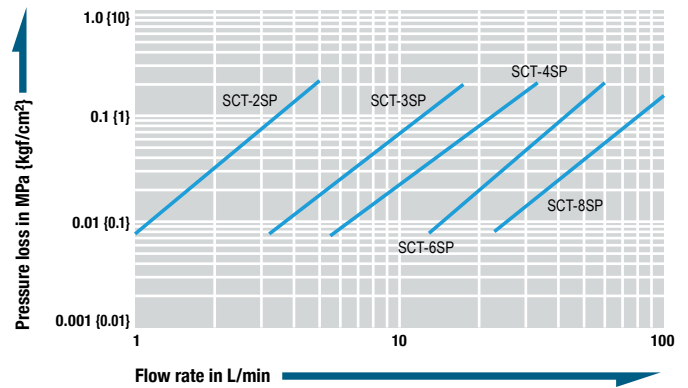

### Models and Dimensions

WAF : WAF stands for width across flats.

Model	Mass (g)	Dimensions (mm)				
		L	A	∅C	H(WAF)	T
SCT-2P	43	59	30.5	27.5	24	Rc 1/4
SCT-2P-NPT						1/4-18NPT
SCT-3P	77	68.5	33.5	34.5	30	Rc 3/8
SCT-3P-NPT						3/8-18NPT
SCT-4P	91	69.5	37.5	39.5	36	Rc 1/2
SCT-4P-NPT						1/2-14NPT
SCT-6P	160	78.5	45	48	41	Rc 3/4
SCT-6P-NPT						3/4-14NPT
SCT-8P	300	112	60.5	59	50	Rc 1
SCT-8P-NPT						1-11.5NPT

Model	Mass (g)	Dimensions (mm)			
		L	∅D	H(WAF)	T
SCT-2S	101	89.5	41	19	Rc 1/4
SCT-2S-NPT					1/4-18NPT
SCT-3S	156	102	49.5	24	Rc 3/8
SCT-3S-NPT					3/8-18NPT
SCT-4S	192	107	54.5	30	Rc 1/2
SCT-4S-NPT					1/2-14NPT
SCT-6S	340	123	68	36	Rc 3/4
SCT-6S-NPT					3/4-14NPT
SCT-8S	770	172.5	82	46	Rc 1
SCT-8S-NPT					1-11.5NPT

\* Available end configurations are female ISO Rc thread and female NPT thread.

\* Plug or socket with female ISO Rc end configuration has V-groove on the body as identification. (In case of female NPT thread, no V-groove on either plug or socket body).

\* Please inquire for other end configurations other than female thread (e.g. flanged or male thread).

Before use, please be sure to read "Safety Guide" described at the end of this book and "Instruction Sheet" that comes with the products.

For High Purity Chemicals

# SEMICON CUPLA

## SCAL Type

For semiconductor manufacturing equipment

<b>Working pressure</b>	<b>Valve structure</b>	<b>Applicable fluids</b>			
0.2 MPa (2 kgf/cm <sup>2</sup> )	Two-way shut-off (Non-Spill)	High purity chemicals	Water	Gas	Air

## Body is polytetrafluoroethylene (PTFE).

- Polytetrafluoroethylene (PTFE) body gives excellent resistance to chemicals.
- Unique seal design ensures minimal liquid spill.
- Both socket and plug have built-in automatic shut-off valves that prevent fluid from outflowing when disconnected.
- No dissolution of metal ions from part in contact with liquid ensures excellent reliability.
- Push-to-connect design.
- Flanged socket body makes it easy to push down sleeve even when wearing gloves.
- All components are cleaned, assembled, inspected and then packed in a clean room.
- Concaved surface of the plug end prevents liquid loss and protects the plug seal surface from damage if dropped or hit.
- To prevent incorrect connection, a keyed type sleeve is available on a made-to-order basis.
- Ten key angle positions are available. The appearance of the keyed type body slightly differs from that of the standard type.



Specifications					
Body material	Polytetrafluoroethylene (PTFE)				
Size (Thread)	1/4", 3/8", 1/2", 3/4", 1" 1/4-18NPT, 3/8-18NPT, 1/2-14NPT, 3/4-14NPT, 1-11.5NPT				
Pressure unit	MPa	kgf/cm <sup>2</sup>	bar	PSI	
Working pressure	0.2	2	2	29	
Seal material	Socket O-ring	Seal material	Mark	Working temperature range	Remarks
		Perfluoroelastomer	P		
Working temperature range	Valve	Fluoropolymer resin (PFA)			

Maximum Tightening amount (approximate)	
1 <sup>3</sup> / <sub>4</sub> to 2 turns	1/4" · 3/8" · 1/2" · 3/4" · 1" Size

Whichever method, overtightening may damage the thread and cause leakage, so take extra care.

**Interchangeability**  
Sockets and plugs can be connected regardless of end configurations if the number □ in the model name {SCAL-□S (P)} is the same.

Minimum Cross-Sectional Area (mm <sup>2</sup> )						
Model (SCAL-□)	2S (-NPT) X 2P (-NPT)	3S (-NPT) X 3P (-NPT)	4S (-NPT) X 4P (-NPT)	6S (-NPT) X 6P (-NPT)	8S (-NPT) X 8P (-NPT)	12S (-NPT/-FL-P) X 12P (-NPT/-FL-P)
Min. Cross-Sectional Area	24	41	59	108	234	611

Volume of Spillage per Disconnection (mL)						
Model (SCAL-□)	2S (-NPT) X 2P (-NPT)	3S (-NPT) X 3P (-NPT)	4S (-NPT) X 4P (-NPT)	6S (-NPT) X 6P (-NPT)	8S (-NPT) X 8P (-NPT)	12S (-NPT/-FL-P) X 12P (-NPT/-FL-P)
Volume of spillage	0.07	0.09	0.13	0.20	0.59	1.26

**Flow Rate – Pressure Loss Characteristics**  
[Test conditions] • Fluid : Water • Temperature : 20°C±5°C

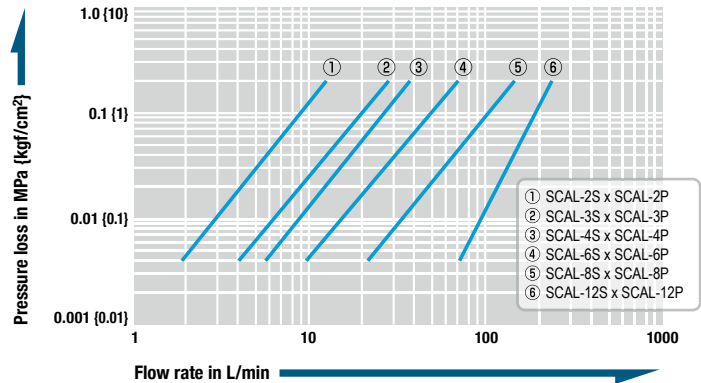

### Models and Dimensions

WAF : WAF stands for width across flats.

Model	Mass (g)	Dimensions (mm)			
		L	øD	H(WAF)	T
SCAL-2P	37	50	27.5	24	Rc 1/4
SCAL-2P-NPT					1/4-18NPT
SCAL-3P	73	63	34.5	30	Rc 3/8
SCAL-3P-NPT					3/8-18NPT
SCAL-4P	107	72	39.5	36	Rc 1/2
SCAL-4P-NPT					1/2-14NPT
SCAL-6P	153	77	48	41	Rc 3/4
SCAL-6P-NPT					3/4-14NPT
SCAL-8P	348	109	59	50	Rc 1
SCAL-8P-NPT					1-11.5NPT
*SCAL-12P-NPT	740	126	80	75	1 1/2-11.5NPT

\*Made-to-order item

- Plug comes with a cap made of high density polyethylene (HDPE).
- Outer appearance of NPT thread type differs slightly from that of the above.
- Please contact us about end configurations other than female thread such as flange and male thread.
- Excessive tightening will damage the threaded part and result in leakage.
- Note: A very small amount of gas can permeate polytetrafluoroethylene (PTFE) bellows in the socket.

Model	Mass (g)	Dimensions (mm)			
		L	øD	H(WAF)	T
SCAL-2S	97	(60.5)	40.5	27	Rc 1/4
SCAL-2S-NPT					1/4-18NPT
SCAL-3S	135	(69.5)	47	32	Rc 3/8
SCAL-3S-NPT					3/8-18NPT
SCAL-4S	177	(76)	52	36	Rc 1/2
SCAL-4S-NPT					1/2-14NPT
SCAL-6S	339	(90)	65	46	Rc 3/4
SCAL-6S-NPT					3/4-14NPT
SCAL-8S	656	(109)	80	60	Rc 1
SCAL-8S-NPT					1-11.5NPT
*SCAL-12S-NPT	1580	(144.5)	108	80	1 1/2-11.5NPT

\*Made-to-order item

Before use, please be sure to read "Safety Guide" described at the end of this book and "Instruction Sheet" that comes with the products.

# For High Purity Chemicals

# SEMICON CUPLA

## SCF Type

For semiconductor manufacturing equipment

Working pressure <b>0.2</b> 0.2 MPa (2 kgf/cm <sup>2</sup> )	Valve structure  Two-way shut-off	Applicable fluids  High purity chemicals Water Gas Air
---	---	---

## All plastic model. Fluoropolymer resin (PFA) body.

- All parts made of fluoropolymer resin. O-rings in particular are FEP-covered fluororubber with excellent chemical resistance and no rubber elution.
- To connect with a plug, just push the socket on to it. Disconnection is done in simple and one-handed button operation.
- Unique "double lock mechanism" prevents accidental disconnection of socket and plug.
- Branched tube port improves operability and reduces required piping space.
- Plugs come with a dust cap.
- All components are cleaned, assembled, inspected, and then packed in a clean room.

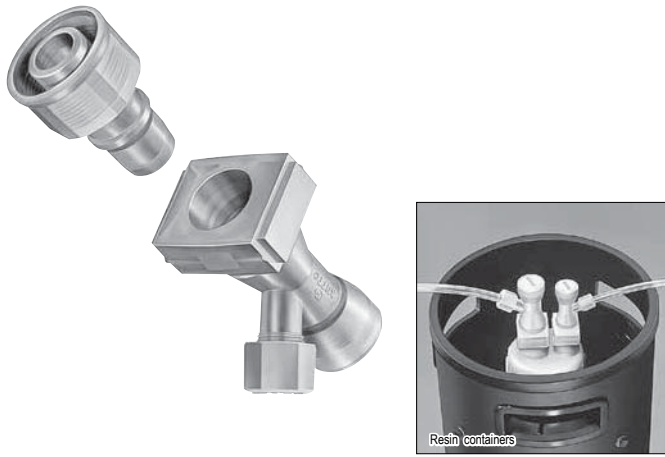

Specifications				
Body material		Fluoropolymer resin (PFA)		
Size	Thread	3/8", 1/2" / M26, M32		
	Tube barb	ø6 mm x ø8 mm, ø8 mm x ø10 mm		
Pressure unit	MPa	kgf/cm <sup>2</sup>	bar	PSI
Working pressure	0.2	2	2	29
Seal material	Socket O-ring	Seal material	Mark	Working temperature range
Working temperature range	Valve	FEP-covered fluoro rubber	-	+5°C to +50°C
		Fluoropolymer resin (PFA)		
		Remarks	Standard material	

### Interchangeability

Sockets and plugs can be connected regardless of end configurations if the number □ in the model name (SCF-□S (P)) is the same.

Model	SCF-2SP	SCF-3SP
Minimum cross-sectional ar	23.8	44.2

### Flow Rate – Pressure Loss Characteristics

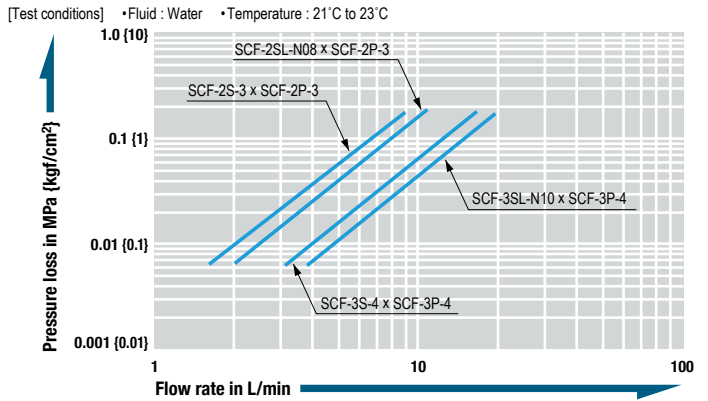

### Reference diagram The thread dimensions of container side for the plug.

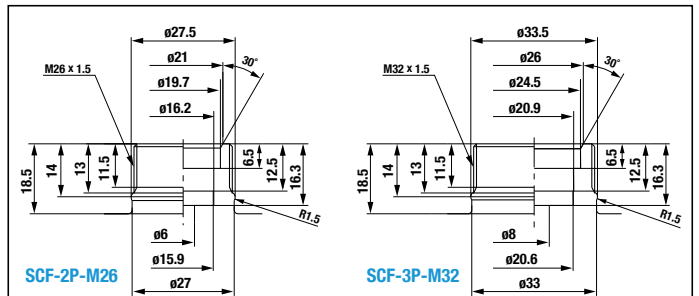

For tolerance and other specific dimensions, consult us.

### Models and Dimensions

WAF : WAF stands for width across flats.

#### Plug Female thread

Model	Container capacity	Mass (g)	Dimensions (mm)			
			L	D(WAF)	C	T
SCF-2P-M26	For 10L to 20L	33	(53.7)	Hex.30 x ø32.5	(31.2)	M26 x 1.5
SCF-3P-M32	For 10L to 20L	50	(57.7)	Hex.36 x ø39	(35.2)	M32 x 1.5

#### Plug Straight type (Female thread)

Model	Mass (g)	Dimensions (mm)						
		L	C	øD	H(WAF)	A(WAF)	øB	T
SCF-2P-3	53	(67.2)	(31.2)	32.5	Hex.30	24	27	Rc 3/8
SCF-3P-4	79	(71.2)	(35.2)	39	Hex.36	30	33	Rc 1/2

#### Socket For tube connection

Model	Container capacity	Mass (g)	Dimensions (mm)				Applicable tube
			L	D	E	T	
SCF-2SL-N08	For 10L to 20L	76	77	34	(45)	ø6 x ø8	
SCF-3SL-N10	For 10L to 20L	116	85	39	(51)	ø8 x ø10	

#### Socket Straight type (Female thread)

Model	Mass (g)	Dimensions (mm)					
		L	øA	H(WAF)	D	E	T
SCF-2S-3	83	(92)	27	24	33	(45)	Rc 3/8
SCF-3S-4	124	(102.5)	33	30	39	(51)	Rc 1/2

Before use, please be sure to read "Safety Guide" described at the end of this book and "Instruction Sheet" that comes with the products.



# For Inert Gas and Vacuum

# SP-V CUPLA

## For vacuum

### Working pressure



### Valve structure



### Applicable fluids

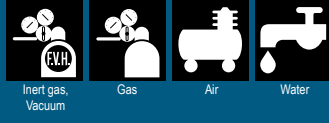

Automatic shut-off valves in both socket and plug for vacuum applications. Each can withstand a vacuum of as high as  $1.3 \times 10^{-1}$  Pa even when disconnected.

- Uses automatic shut-off valves with ultra-tight sealed construction in both socket and plug. Ideal for vacuum applications.
- Having automatic shut-off valves in both socket and plug facilitates easy fluid handling. Suitable for a wide range of vacuum applications as high as  $1.3 \times 10^{-1}$  Pa [ $1 \times 10^{-3}$  mmHg] even when disconnected.
- Three types of seal material are available to suit any of the diversified production lines for air conditioners, refrigerators or similar.
- Can be connected with SP CUPLA Type A.

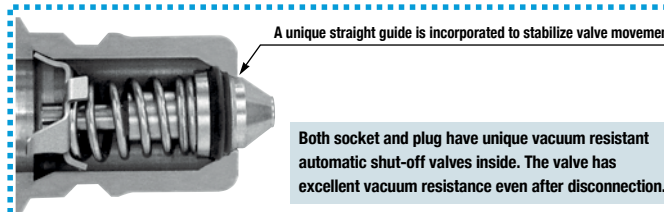
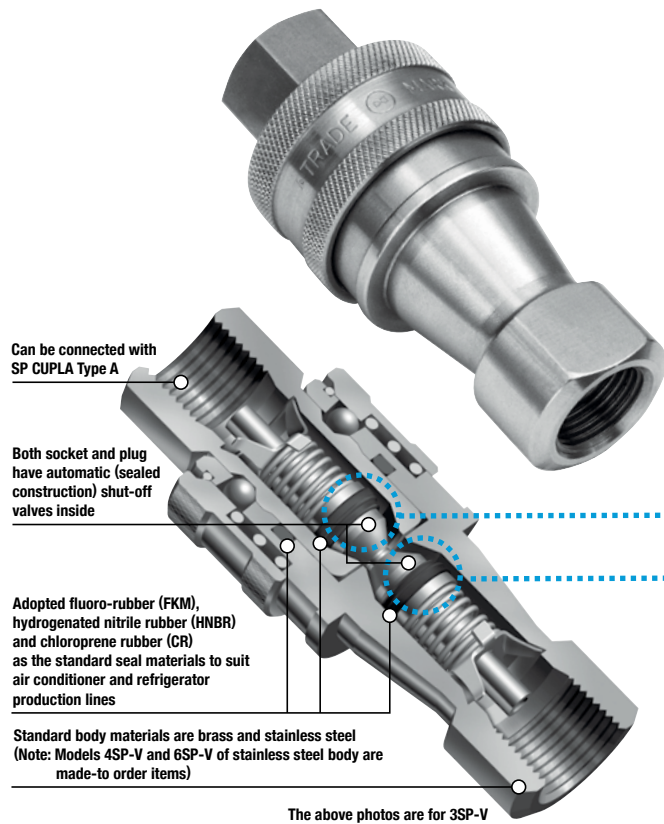

## Specifications

Body material	Brass (Standard material)		Stainless steel (Standard material)	Stainless steel (Made-to-order item)	
	1/4", 3/8"	1/2", 3/4"	1/4", 3/8"	1/2", 3/4"	
Working pressure	MPa	5.0	3.0	7.5	4.5
	kgf/cm <sup>2</sup>	51	31	76	46
	bar	50	30	75	45
	PSI	725	435	1090	653
Seal material	Seal material	Mark	Working temperature range	Remarks	
	Chloroprene rubber	CR (C308)	-20°C to +80°C	Standard material	
	Fluoro rubber	FKM (X-100)	-20°C to +180°C	Standard material	
Working temperature range	Hydrogenated nitrile rubber	HNBR (H708)	-20°C to +120°C	Standard material	

\* No grease is applied to the O-ring of the socket for HNBR seal material products when shipping. Be sure to apply refrigerating machine oil before use.

## Maximum Tightening Torque

## Nm {kgf·cm}

Size (Thread)	1/4"		3/8"		1/2"		3/4"	
	Brass	Stainless steel	Brass	Stainless steel	Brass	Stainless steel	Brass	Stainless steel
Torque	9 {92}	14 {143}	12 {122}	22 {224}	30 {306}	60 {612}	50 {510}	90 {918}

## Flow Direction

Fluid flow can be bi-directional when socket and plug are connected.

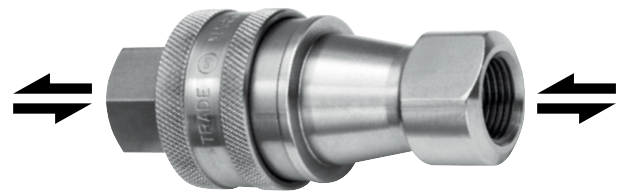

## Interchangeability

Socket and plug of different sizes cannot be connected. Interchangeable with SP CUPLA Type A but take heed of flow rate change.

## Minimum Cross-Sectional Area

## (mm<sup>2</sup>)

Model	2SP-V	3SP-V	4SP-V	6SP-V
Minimum cross-sectional area	18	38	71	110

## Suitability for Vacuum

## $1.3 \times 10^{-1}$ Pa [ $1 \times 10^{-3}$ mmHg]

Socket only	Plug only	When connected
Operational	Operational	Operational

## Admixture of Air on Connection

May vary depending upon the usage conditions.

## (mL)

Model	2SP-V	3SP-V	4SP-V	6SP-V
Volume of air	1.0	2.4	3.2	10.5

## Flow Rate – Pressure Loss Characteristics

[Test conditions] • Fluid : Water • Temperature : 24°C±6°C

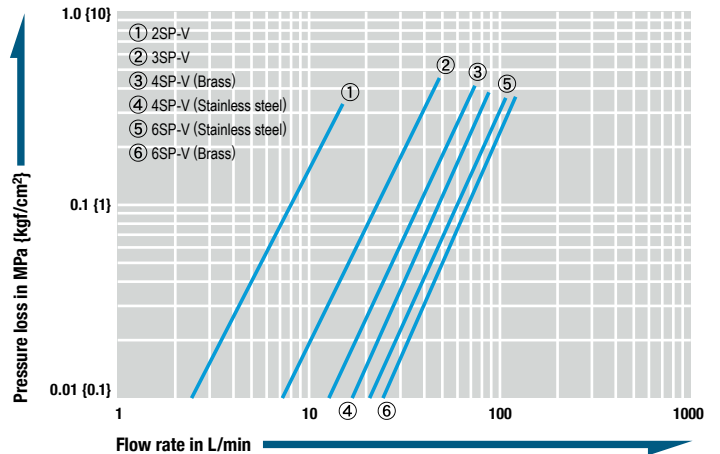

Models and Dimensions

**Plug Female thread**

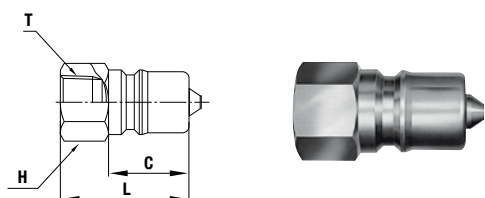

Model	Application (Thread)	Mass (g)		Dimensions (mm)			
		Brass	Stainless steel	L	H(WAF)	C	T
2P-V	R 1/4	39	34	36	Hex.17	22	Rc 1/4
3P-V	R 3/8	67	59	40	Hex.21	25	Rc 3/8
4P-V	R 1/2	123	118	44	Hex.29	28	Rc 1/2
6P-V	R 3/4	211	202	52	Hex.35	36	Rc 3/4

**Socket Female thread**

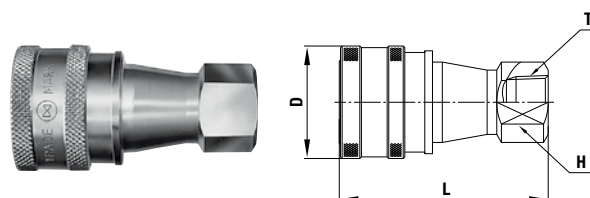

Model	Application (Thread)	Mass (g)		Dimensions (mm)			
		Brass	Stainless steel	L	øD	H(WAF)	T
2S-V	R 1/4	136	127	58	(28)	19	Rc 1/4
3S-V	R 3/8	217	197	65	(35)	21	Rc 3/8
4S-V	R 1/2	421	393	72	45	29	Rc 1/2
6S-V	R 3/4	709	658	88	55	35	Rc 3/4

\* The sleeve shape of 4S-V and 6S-V differs from that of the above photo.

**Seal Materials for Refrigerants**

Various eco-friendly refrigerants for air conditioner and refrigerator have been developed. Nitto Kohki, having invested years in the research and development of excellent seal materials to withstand refrigerants and refrigerant oils, has made early attempts to develop and manufacture the seal materials for these eco-friendly refrigerants.

	Seal material	
	Hydrogenated nitrile rubber	Chloroprene rubber
Mark	HNBR (H708)	CR (C308)
Features	Resistant to hydrofluorocarbons (HFC-134a, HFC-407C, HFC-410A, HFC-404A), and PAG type and ester type oils. Also resistant to heat up to 120°C	Excellent resistance to hydrofluorocarbons (HCFC-22 and HFC-134a)
Application	Refrigerator production lines Air conditioner production lines	Air conditioner production lines

**Comparison of External Appearance**

When two different gases are used simultaneously in the production lines, SP-V-GN type and SP-V-GNN type (non-interchangeable with standard SP-V and each others) may be required in order to prevent connections to improper lines by mistakes. They are made-to-order items. For details please contact Nitto Kohki direct or its distributor in your country.

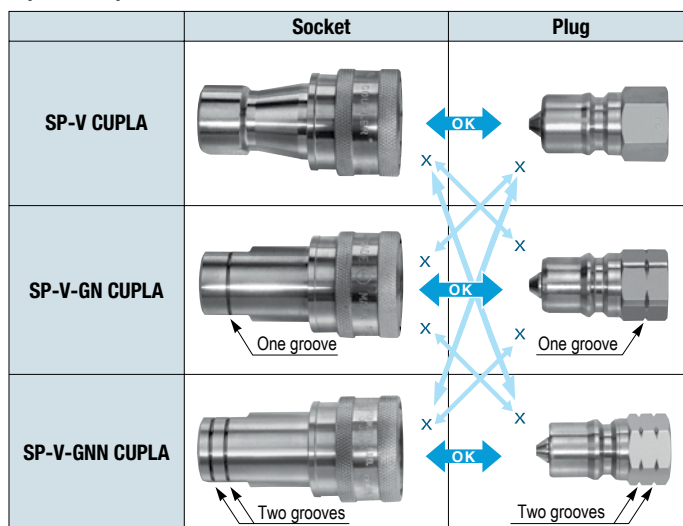

X indicates incompatibility.

**Application Example**

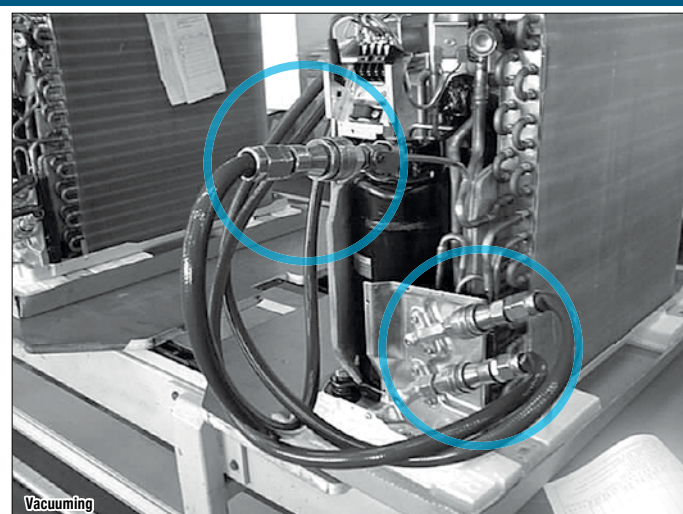
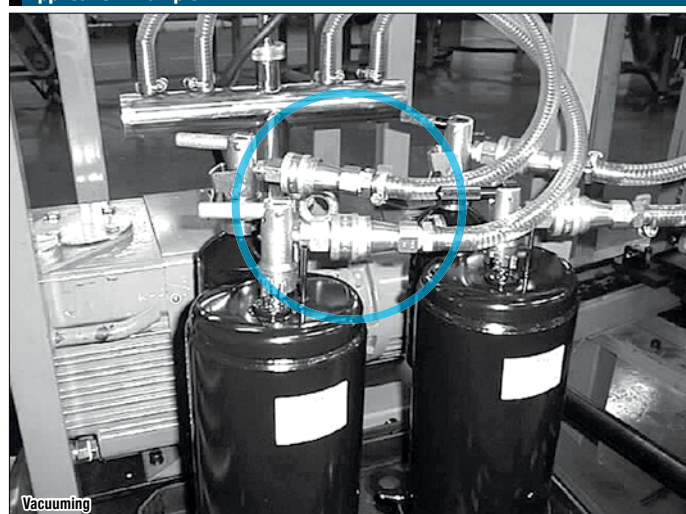

For Inert Gas and Vacuum

# PCV PIPE CUPLA

For connection to copper pipes

Working pressure

**4.5**  
4.5 MPa  
(46 kgf/cm<sup>2</sup>)

Valveless

Applicable fluids

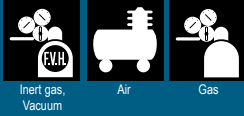

**Clamps directly on straight copper pipes !**  
**Double seal construction withstands a vacuum of up to  $1.3 \times 10^{-1}$  Pa.**

- Clamps directly on to straight copper pipes eliminating unnecessary welding or flaring.
- Withstands a vacuum of up to  $1.3 \times 10^{-1}$  Pa (when connected) making it possible to be used in leak testing, vacuum suction and refrigerant charge.
- Select from three standard types of seal materials to be used with fluids for air conditioner and refrigerator production lines. Many models to suit various pipe sizes.
- One lever operation simultaneously clamps and seals pipe. Double seal construction for tight fit on end and outside surface of pipe ensures excellent sealing and vacuum resistance.

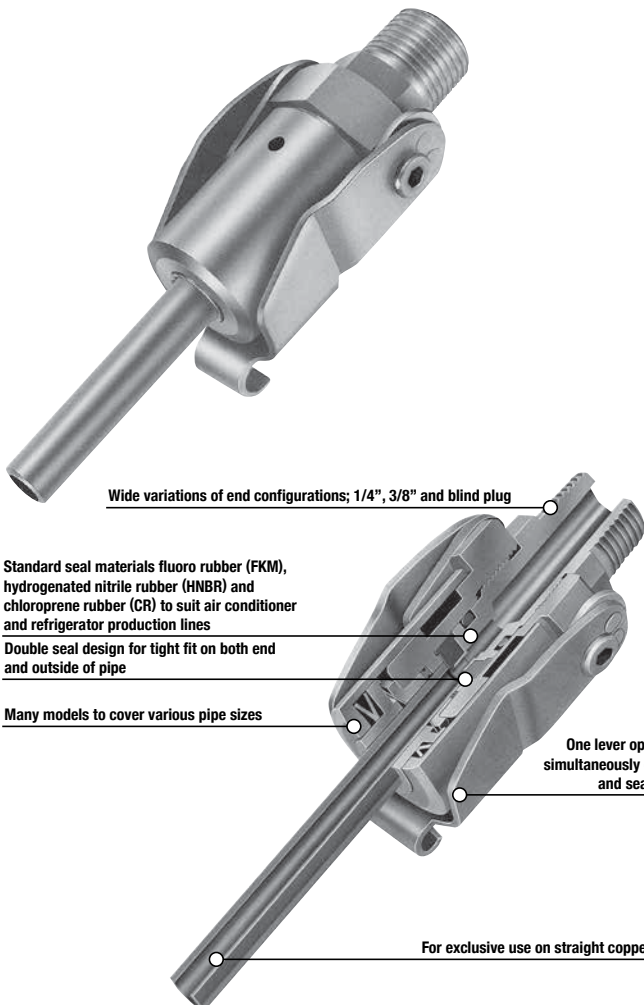

## Specifications

Model	PCV400	PCV470	PCV500	PCV600	PCV630	PCV800	PCV950	PCV1000	PCV1270	PCV1590
Copper pipe OD mm	ø4.0	ø4.76 (3/16")	ø5.0	ø6.0	ø6.35 (1/4")	ø8.0 (5/16")	ø9.52 (3/8")	ø10.0	ø12.7 (1/2")	ø15.88 (5/8")
Body material	Brass									
Pressure unit	MPa		kgf/cm <sup>2</sup>		bar		PSI			
Working pressure	4.5		46		45		653			
Seal material Working temperature range	Seal material		Mark		Working temperature range		Remarks			
	Chloroprene rubber		CR (C308)		-20°C to +80°C		Standard material			
	Fluoro rubber		FKM (X-100)		-20°C to +180°C		Standard material			
Hydrogenated nitrile rubber		HNBR (H708)		-20°C to +120°C		Standard material				

\* Hydrogenated nitrile rubber (HNBR) is colored in blue for easy recognition.

## Maximum Tightening Torque

Nm {kgf·cm}

Size (Thread)	1/4"	3/8"
Torque	9 {92}	12 {122}

## Flow Direction

Fluid flow can be bi-directional when socket and plug are connected.

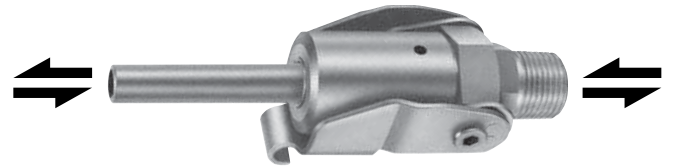

## Minimum Cross-Sectional Area

(mm<sup>2</sup>)

Model	PCV400	PCV470	PCV500	PCV600	PCV630	PCV800
Min. cross-sectional area	3.8	3.8	3.8	9.1	9.1	16.6
Model	PCV950	PCV1000	PCV1270-2	PCV1270-3	PCV1590-2	PCV1590-3
Min. cross-sectional area	16.6	16.6	50.3	73.9	50.3	78.5

## Suitability for Vacuum

$1.3 \times 10^{-1}$  Pa { $1 \times 10^{-3}$  mmHg}

CUPLA only	When connected to a pipe
—	Operational

## Pipe Outside Diameter, Insert Length of Pipe into CUPLA, and Minimum Thickness of Pipe Wall

(mm)

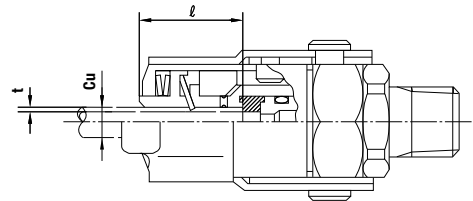

Items with asterisk (\*) are made-to-order products.

Product Group	Pipe OD (Cu)	Insert Length of Pipe into CUPLA (l)	Minimum Thickness of Pipe Wall (t)
PCV400*	ø4.0	19	0.8 or more
PCV470	ø4.76 (3/16")		
PCV500*	ø5.0		
PCV600	ø6.0		
PCV630	ø6.35 (1/4")		
PCV800	ø8.0 (5/16")	20.5	0.8 or more
PCV950	ø9.52 (3/8")		
PCV1000*	ø10.0		
PCV1270	ø12.7 (1/2")	30	1.0 or more
PCV1590	ø15.88 (5/8")		



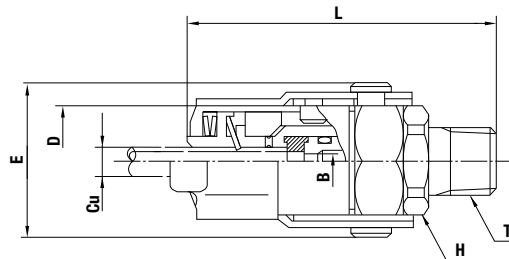
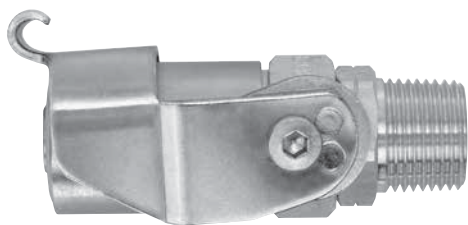

Product Group	Copper pipe OD mm	Model	Application (Thread)	Mass (g)	Dimensions (mm)					
					L	øD	H(WAF)	øB	E	T
PCV400 *	ø4.0	PCV400-2	Rc 1/4	155	(59)	22.2	Hex.17	2.2	(32.5)	R 1/4
		PCV400-3	Rc 3/8	155	(60)		Hex.19			R 3/8
PCV470	ø4.76 (3/16)	PCV470-2	Rc 1/4	155	(60)	22.2	Hex.17	2.2	(32.5)	R 1/4
		PCV470-3	Rc 3/8	160	(61)		Hex.19			R 3/8
		PCV470-0	Blind plug	160	(47)	-	-	-		
PCV500 *	ø5.0	PCV500-2	Rc 1/4	155	(59)	22.2	Hex.17	2.2	(32.5)	R 1/4
		PCV500-3	Rc 3/8	155	(60)		Hex.19			R 3/8
PCV600	ø6.0	PCV600-2	Rc 1/4	150	(60)	22.2	Hex.17	3.4	(32.5)	R 1/4
		PCV600-3	Rc 3/8	155	(61)		Hex.19			R 3/8
		PCV600-0	Blind plug	155	(47)	-	-	-		
PCV630	ø6.35 (1/4)	PCV630-2	Rc 1/4	145	(60)	22.2	Hex.17	3.4	(32.5)	R 1/4
		PCV630-3	Rc 3/8	150	(61)		Hex.19			R 3/8
		PCV630-0	Blind plug	150	(47)	-	-	-		
PCV800	ø8.0 (5/16)	PCV800-2	Rc 1/4	175	(62)	24.8	Hex.17	4.6	(35.5)	R 1/4
		PCV800-3	Rc 3/8	180	(63)		Hex.19			R 3/8
		PCV800-0	Blind plug	185	(50)	-	-	-		
PCV950	ø9.52 (3/8)	PCV950-2	Rc 1/4	175	(62)	24.8	Hex.17	4.6	(35.5)	R 1/4
		PCV950-3	Rc 3/8	180	(63)		Hex.19			R 3/8
		PCV950-0	Blind plug	180	(50)	-	-	-		
PCV1000 *	ø10.0	PCV1000-2	Rc 1/4	155	(62)	24.8	Hex.17	4.6	(35.5)	R 1/4
		PCV1000-3	Rc 3/8	155	(63)		Hex.19			R 3/8
PCV1270	ø12.7 (1/2)	PCV1270-2	Rc 1/4	470	(80)	34.8	Hex.24	8.0	(45.0)	R 1/4
		PCV1270-3	Rc 3/8	465	(81)		Hex.24			R 3/8
		PCV1270-0	Blind plug	475	(68)	-	-	-		
PCV1590	ø15.88 (5/8)	PCV1590-2	Rc 1/4	424	(80)	34.8	Hex.24	8.0	(45.0)	R 1/4
		PCV1590-3	Rc 3/8	435	(81)		Hex.24			R 3/8
		PCV1590-0	Blind plug	445	(68)	-	-	-		

\* For mass with a plug, add (brass body) 2P-V : 39 g, 3P-V : 67 g, (stainless steel body) 2P-V : 34 g, or 3P-V : 59 g  
 \* Available on request

Clamping Mechanism

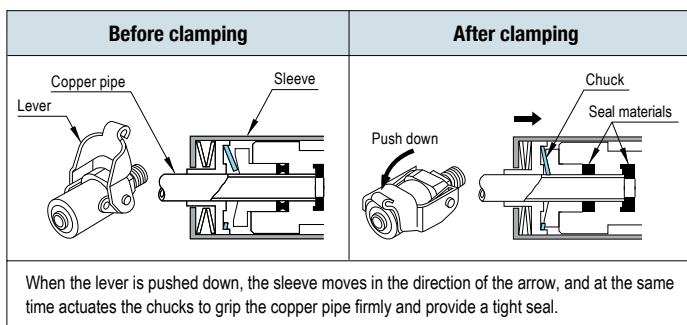

Application Example

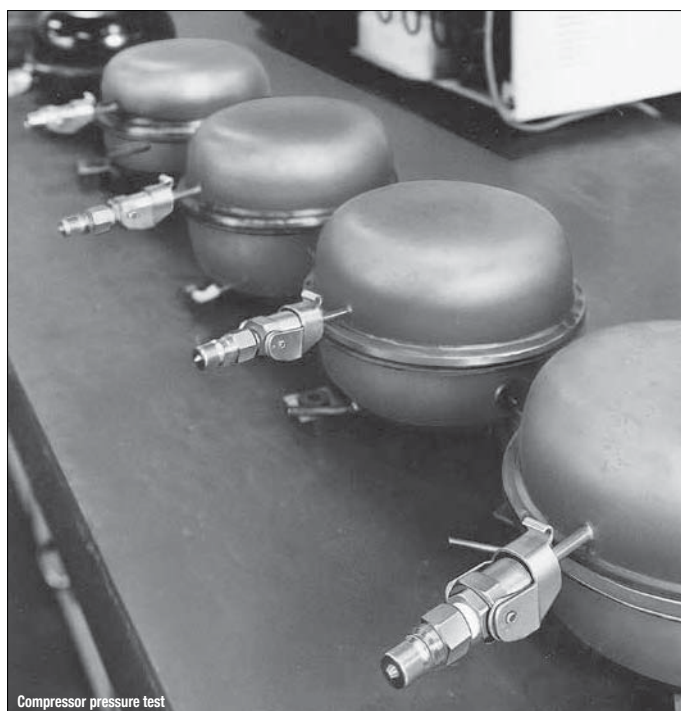



For Paint

# PAINT CUPLA

Piping for painting equipment

<p>Working pressure</p> <p>1.0 MPa (10 kgf/cm<sup>2</sup>)</p>	<p>Valve structure</p> <p>One-way shut-off</p>	<p>Applicable fluid</p> <p>Solvent based paint</p>
--	--	--

Quick connection and disconnection of paint spray gun and paint fluid line is realized.

- Unique swing connection system enables easy connection and disconnection of paint spray gun and paint hose even by gloved hands.
- Full-open gate valve mechanism prevents paint precipitate buildup.
- Adoption of special resin seal that has resistance against solvents made it possible to feature superior durability, long stable capability, and easy cleaning of paint spray gun after the job.
- Connection and disconnection can be made even if paint sticks to the socket sleeve.
- Small and lightweight design (80 g per set) reduces the weight to be held by hand of operators.
- Built-in sleeve lock mechanism prevents accidental disconnection of CUPLA, ensuring safe operation.
- Wide variety of end configurations (standard thread: G 3/8) are available in response to various paint spray guns.



### Flow Direction

Fluid must run from socket to plug.



### Models and Dimensions

#### Plug PE-3P type (Female thread)

NPS end configuration has an identification groove on the CUPLA.

Model	Application (Thread)	Mass (g)	Dimensions (mm)				
			L	øD	øB	H(WAF)	T
PE-3P-G	G 3/8	31	(58)	24	4.5	19	G 3/8
PE-3P-NPS	3/8 NPS	31	(58)	24	4.5	19	3/8 NPS

### Specifications

Body material	Socket : Aluminum alloy Plug : Stainless steel			
Size (Thread)	3/8", 3/8NPS			
Pressure unit	MPa	kgf/cm <sup>2</sup>	bar	PSI
Working pressure	1.0	10	10	145
Seal material	Seal material	Mark	Working temperature range	Remarks
Working temperature range	Fluoro-resin	PFA	0°C to +50°C	Standard material

### Tightening Torque Range

Nm {kgf·cm}

Torque	15 {153}
--------	----------

### Interchangeability

Sockets and plugs can be connected regardless of end configurations.

### Suitability for Vacuum

Not suitable for vacuum application in either connected or disconnected condition.

### Flow Rate – Pressure Loss Characteristics

[Test conditions] • Fluid viscosity :  $8 \times 10^{-7}$  m<sup>2</sup>/s (Equivalent to water) • Temperature : 30°C±5°C

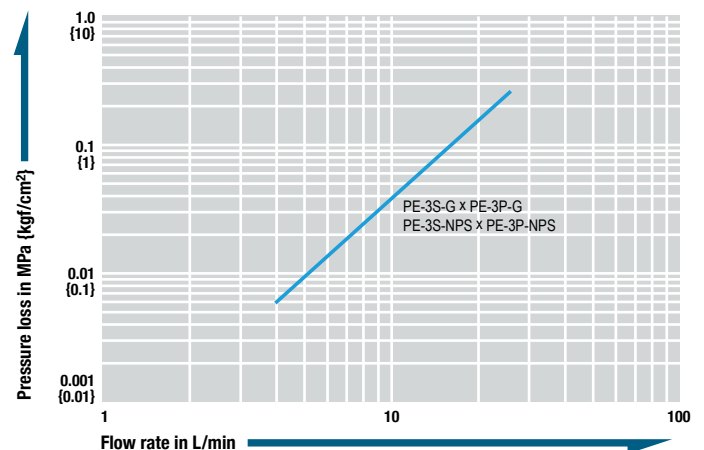

### Connection and Disconnection

#### Connection

Align the key on plug cover to the slot on sleeve, then while pulling the socket sleeve insert the plug to the hilt.

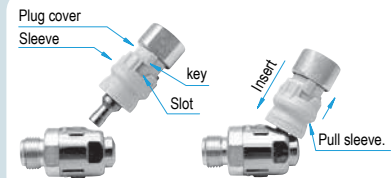

While keeping the plug inserted into the socket, tilt the plug so as to align the plug with the socket. Lock can be made by turning the sleeve.

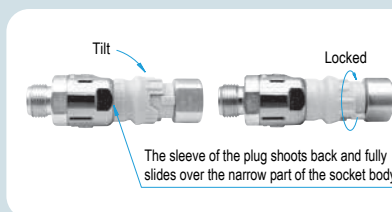

#### Disconnection

Disconnect in the reverse order of connection.

WAF : WAF stands for width across flats.

#### Socket PE-3S type (Male thread)

NPS end configuration has an identification groove on the CUPLA.

Model	Application (Thread)	Mass (g)	Dimensions (mm)			
			L	øD	H(WAF)	T
PE-3S-G	G 3/8	48	(47)	27	23	G 3/8
PE-3S-NPS	3/8 NPS	48	(47)	27	23	3/8 NPS

Before use, please be sure to read "Safety Guide" described at the end of this book and "Instruction Sheet" that comes with the products.

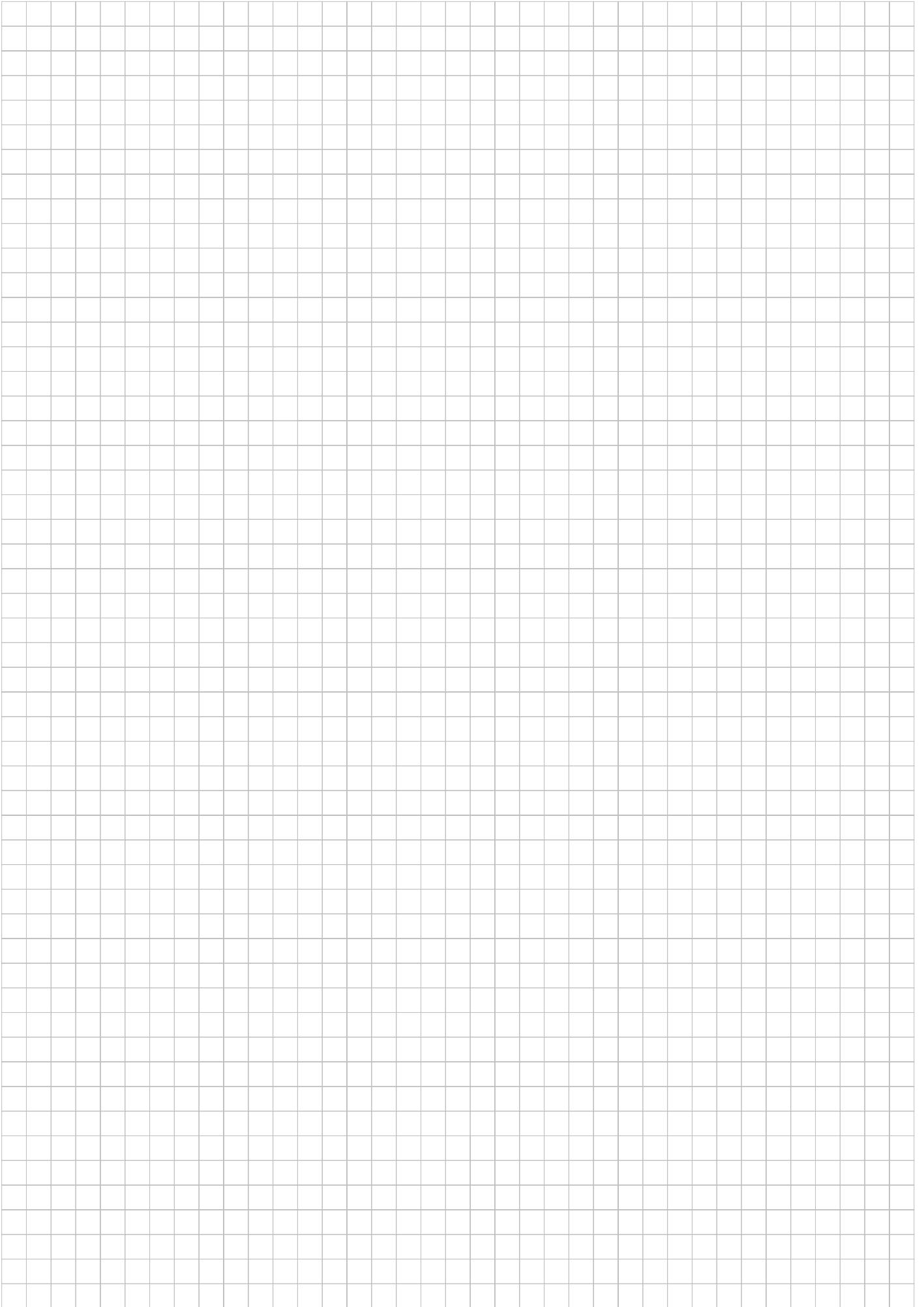

For Food

# HYGIENIC CUPLA

## Easy Wash Type

Disassemble and wash type / For food manufacturing piping

<b>Working pressure</b> 1.0 1.0 MPa (10 kgf/cm <sup>2</sup> )	<b>Valve structure</b> Straight through	<b>Applicable fluids</b> Food, Drinking water Water Powder Air
--	--	--

Solves the troubles of ferrule joints by the effortless operation unique to CUPLA. Easy disassembly and cleanability help in hygienic management of HACCP.

- It can be connected by just inserting the plug to the socket and twisting the "Safety lock".
- The "Safety lock" feature ensures that there can be no unintentional disconnection of the coupling.
- O-rings that conforms to the Food sanitation Act of Japan is adopted.
- An operator friendly design. Seal parts will not drop off during connection like conventional fittings.
- Stainless steel (JIS SUS316L equivalent) for the liquid contact parts, and finished with buffing (#400).

Smart Connect and Disconnect



**Ferrule type**  
(ISO 2852 standard)

**Welding type**  
(JIS G 3447 standard)



### Specifications

<b>Body material</b>	Stainless steel [ SCS16 (JIS SUS316L equivalent) ] *1			
<b>Surface finish of the liquid-contact part</b>	Buff finish #400			
<b>Size of end configurations</b>	Welding type *2		Ferrule type *3	
	1.5 S / 2.0 S			
<b>Pressure unit</b>	MPa	kgf/cm <sup>2</sup>	bar	PSI
<b>Working pressure</b>	1.0	10	10	145
<b>Seal material</b> *4 <b>Working temperature range</b>	<b>Seal material</b>	<b>Mark</b>	<b>Working temperature range</b>	<b>Remarks</b>
	Silicone rubber	SI	0°C to +110°C	Standard material
	Fluoro rubber	FKM (X-100)	0°C to +180°C	Available on request
	Ethylene-propylene rubber	EPDM (EPT)	0°C to +150°C	Available on request
<b>O-ring size</b>	1.5 S: P38, 2.0 S: P50 (Dimensions, tolerance: refer to JIS B 2401, Hardness: A70±5)			

\*1: All metal parts are equivalent to SUS304 except those exposed to liquid contact.  
 \*2: The dimensions of the weld zone conform to JIS G 3447 stainless steel sanitary pipe.  
 \*3: Please use ferrule couplings conforming to IDF / ISO 2852.  
 \*4: The seal material conforms to article No.3-D-3-(1) Rubber utensils (except nursing utensils) or Containers / Packages. It has passed both material and elution tests specified in the Food sanitation Act and the standards for Food and Food additives (Notice No.370 of 1959 issued by the Ministry of Health and Welfare of Japan). Conforms to standard No.21CFR 177.2600 of the US Food and Drug Administration (FDA).

### Flow Direction

Fluid flow can be bi-directional when socket and plug are connected.



### Interchangeability

Sockets and plugs can be connected regardless of end configurations if the size is same.

### Suitability for Vacuum

Vacuum pressure: 53 kPa A

Socket only	Plug only	When connected
—	—	Operational

Vacuum performance may vary depending upon working environment and usage conditions.

### Seal part (cross section)

Because of the structure of this product, dead space is generated when using.

Enlarged view of seal part

Plug / Socket Connected state

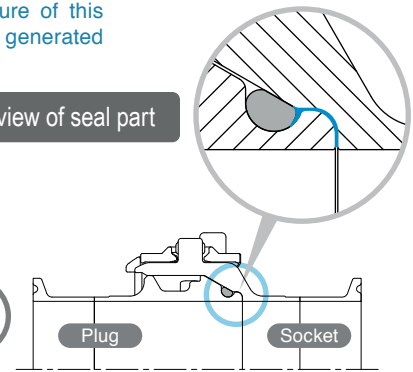

### When installing the CUPLA on the pipe

Connection and disconnection of socket and plug is enabled by sliding either the socket or plug to the central axis of pipe. When connecting the CUPLA to the pipe, ensure that there is at least minimum moving distance (L) in the axial direction.

Amount of sliding (L)  
More than 40 mm

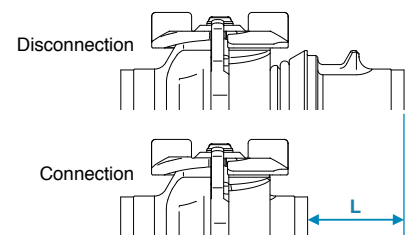

### HACCP: Hazard Analysis and Critical Control Point

HACCP is the management system in which food safety is addressed to the process from production, procurement and handling of raw materials to distribution and consumption of finished products through the analysis and control of biological, chemical and physical hazards.

Models and Dimensions

**Plug** Welding type

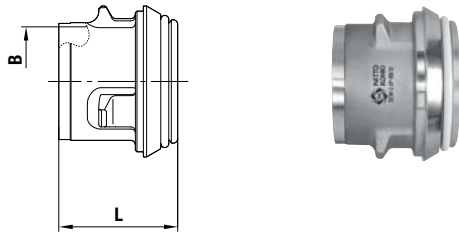

Model	Mass (g)	Dimensions (mm)	
		L	øB
SEW-1.5P-BW *	179	52	35.7
SEW-2.0P-BW *	231	52	47.8

**Socket** Welding type

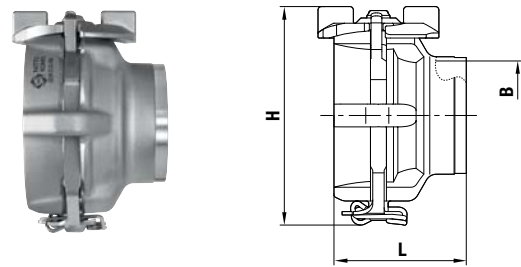

Model	Mass (g)	Dimensions (mm)		
		L	H	øB
SEW-1.5S-BW	364	58	(84)	35.7
SEW-2.0S-BW	455	58	(94)	47.8

**Plug** Ferrule type

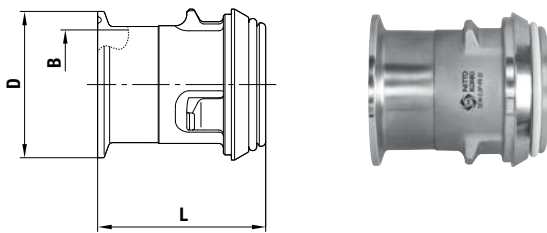

Model	Mass (g)	Dimensions (mm)		
		L	øD	øB
SEW-1.5P-FR *	224	(73.5)	50.5	35.7
SEW-2.0P-FR *	301	(73.5)	64	47.8

**Socket** Ferrule type

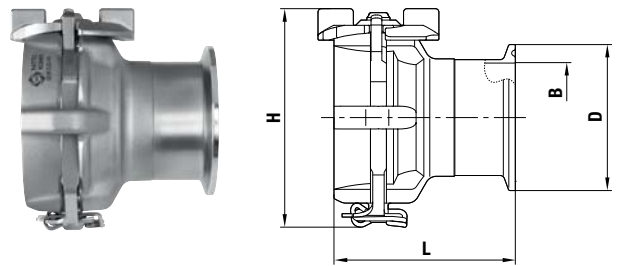

Model	Mass (g)	Dimensions (mm)			
		L	øD	H	øB
SEW-1.5S-FR	407	(79.5)	50.5	(84)	35.7
SEW-2.0S-FR	455	(79.5)	64	(94)	47.8

\* A type without seal material is also available. In such case, the model name ends with "-NP". (ex: SEW-2.0P-BW **-NP** )

Applications

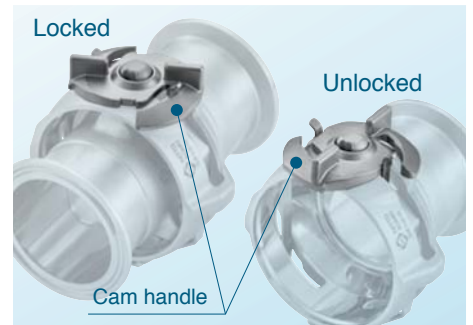

**Easy assembly and disassembly**

No tools are required to disassemble / assemble HYGIENIC CUPLA. Small number of parts that are easy to handle, aiding efficient maintenance.

**Easy washing of the whole unit**

After disassembly, small number of components requires minimum effort when cleaning. No small parts to lose.

**Safety Lock function**

As a safety measure, the "Safety lock" feature ensures that there can be no unintentional disconnection of the CUPLA. By turning the cam handle, you can maintain the connected state of the socket and plug.



**Construction and Safety standards**

Since the O-Ring is attached beforehand, it will not drop off during connection like conventional fittings. And the seal material conforms to article No. 3-D-3-(1) Rubber utensils (except nursing utensils) or Containers / Packages. It has passed both material and elution tests specified in the Food sanitation Act and the standards for Food and Food additives (Notice No.370 of 1959 issued by the Ministry of Health and Welfare of Japan). Also conforms to standard No. 21 CFR 177.2600 of the US Food and Drug Administration (FDA).

Accessory

**DUST CAP** Dust cap for both plug and socket (made of polyethylene).

Prevents contamination of foreign matter into piping during separation.

The Dust Cap conforms to No. 3-D-2-(1) and 3-D-2-(2)-4 Apparatus and Containers / Packages. It has passed both material and elution tests specified in the standards for Food and Food additives. (Notice No.201 of revised March 31, 2006 by the Ministry of Health and Welfare of Japan)



See page 150 for the details.

Consumables

The O-ring and Lock plate ASSY are consumable items. See the following list as a replacement guide for the Lock plate ASSY.

Replacement guide

Replacement parts	Connection and disconnection times
Lock plate ASSY	1000 times

Lock plate ASSY

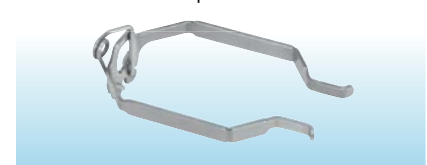

- When the Lock plate ASSY is deformed, replace it with a new one regardless of connection / disconnection times.
- The durability of the O-ring differs depending on the operating environment and conditions (pressure and temperature etc.).



## Index



	Product Name	Page
<b>C</b>	CUPLA with Safety Lock	143
	CUPLA with Single Lock	143
<b>H</b>	HIGH FLOW CUPLA	145
	HIGH FLOW CUPLA BI	146
<b>P</b>	PLASTIC CUPLA BC Type	148
	PLASTIC CUPLA BCC Type	148
<b>S</b>	SP CUPLA Type A PV Type <span style="color: blue;">NEW</span>	147
<b>T</b>	TSP-HP CUPLA for High Pressure	144
	Two-way Shut-off Type Small Size CUPLA	144

## CUPLA with Single Lock CUPLA with Safety Lock

Accidental disconnection prevention mechanism

The standard CUPLA series listed on the lower right can have an additional single lock or a safety lock mechanism to prevent accidental disconnection.

- CUPLA with Single Lock**  
 The sleeve is provided with a cutout and the body of the socket has a projecting lock pin or ball. After connecting the CUPLA, simply turn the sleeve to lock the back and forth movement of the sleeve.
- CUPLA with Safety Lock**  
 A sleeve stopper Lock Ring is provided behind the sleeve. After connecting the CUPLA, simply turning the Lock Ring to disable the back and forth movement of the sleeve (see diagram sketch on the right top).

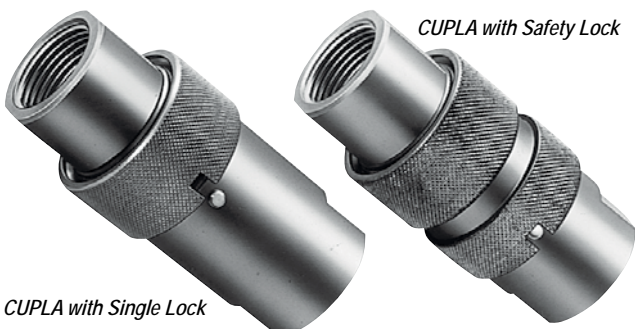

CUPLA with Single Lock

CUPLA with Safety Lock

### How to operate the Safety Lock

#### How to lock

Connected state (before lock)

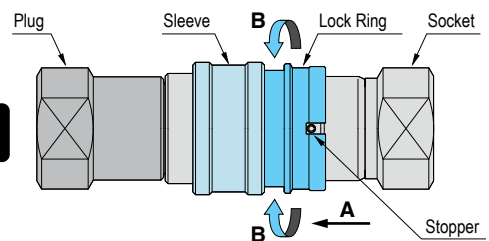

Slide the Lock Ring in the direction of the arrow A and rotate it in either direction simultaneously. When the Stopper is aligned with the shallow cutout on the Lock Ring, the CUPLA will be locked.

#### How to unlock

Connected state (locked)

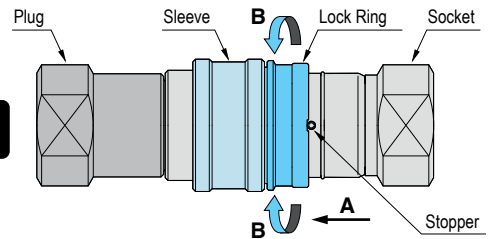

Slide the Lock Ring in the direction of the arrow A and rotate it in either direction simultaneously. When the Stopper is aligned with the deeper cutout on the Lock Ring, the CUPLA will be unlocked.

#### CUPLA with Single Lock

HI CUPLA (Brass) / MOLD CUPLA / SP CUPLA Type A / TSP CUPLA / HSP CUPLA / 210 CUPLA  
 \*The above all with single lock are made-to-order.

The following CUPLA come with single lock as standard feature.

HI CUPLA BL / LOCK CUPLA 200 / HSU CUPLA / 350 CUPLA / FLAT FACE CUPLA F35 / FLAT FACE CUPLA FF / 450B CUPLA



#### CUPLA with Safety Lock

SP CUPLA Type A / TSP CUPLA / HSP CUPLA / 210 CUPLA / 350 CUPLA  
 \*The above all with safety lock are made-to-order.

The following CUPLA come with safety lock as standard feature. HOT WATER CUPLA / S210 CUPLA

# Two-way Shut-off Type Small Size CUPLA

For temperature controllers

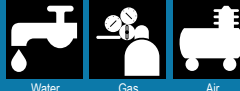
<b>Working pressure</b>	<b>Valve structure</b>	<b>Applicable fluids</b>
 1.0 MPa (10 kgf/cm <sup>2</sup> ) 1.5 MPa (15 kgf/cm <sup>2</sup> )	 Two-way shut-off	 Water Gas Air

- Push-to-connect operation.
- Both socket and plug have built-in automatic shut-off valves to prevent fluid spill out when disconnected.
- Easy connection even in a restricted area.
- Lightweight feature will allow you easy design of multiple piping.

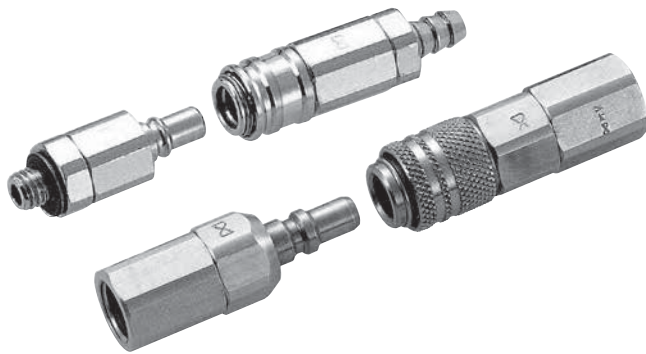

Before use, please be sure to read "Safety Guide" described at the end of this book and "Instruction Sheet" that comes with the products.

## Specifications

Body material	MYU CUPLA		Little CUPLA	
	Stainless steel, Brass (Nickel plated)		Stainless steel	
Size (Thread)	Please check with us.			
Working pressure	MPa	1.0	1.5	
	kgf/cm <sup>2</sup>	10	15	
	bar	10	15	
	PSI	145	218	
Seal material	Seal material	Mark	Working temperature range	Remarks
	Nitrile rubber	NBR (SG)	-20°C to +80°C	Available on request
	Ethylene-propylene rubber	EPDM (EPT)	-40°C to +150°C	
Fluoro rubber	FKM (X-100)	-20°C to +180°C		

## Two-way Shut-off Type Small Size CUPLA Series

Please check with us about the end configurations and sizes.

### MYU CUPLA / MYU type

Min. Cross-Sectional Area: 4.9 mm<sup>2</sup> (ø2.5)

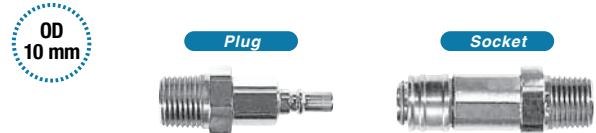

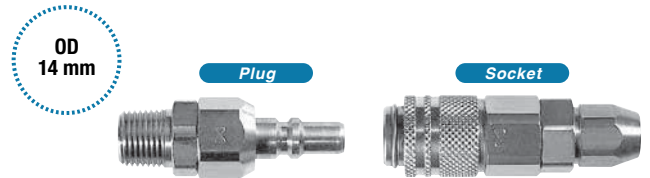

### LITTLE CUPLA / MSV type

Min. Cross-Sectional Area: 6.1 mm<sup>2</sup> (ø2.8)



# TSP-HP CUPLA for High Pressure

For high pressure and general purposes

<b>Working pressure</b>	<b>Valve structure</b>	<b>Applicable fluids</b>
 9.0 MPa (92 kgf/cm <sup>2</sup> )	 Straight through	 Water Hydraulic oil

- Good for high pressure water piping such as in high pressure washers, or car washers.
- Valveless type ensures high flow rate.



## Specifications

Body material	Stainless steel			
Size (Thread)	1/4", 3/8", 1/2"			
Pressure unit	MPa	kgf/cm <sup>2</sup>	bar	PSI
Working pressure	9.0	92	90	1310
Seal material	Seal material	Mark	Working temperature range	Remarks
	Nitrile rubber	NBR (SG)	-20°C to +80°C	Available on request
	Ethylene-propylene rubber	EPDM (EPT)	-40°C to +150°C	

Before use, please be sure to read "Safety Guide" described at the end of this book and "Instruction Sheet" that comes with the products.

## Models and Dimensions

WAF : WAF stands for width across flats.

### Plug TPF type (Female thread)

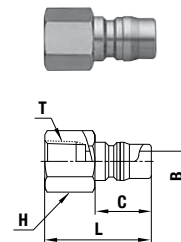

Model	Application (Thread)	Dimensions (mm)				
		L	H(WAF)	C	T	øB
2TPF-HP	R 1/4	34	Hex.17	18	Rc 1/4	6.5
3TPF-HP	R 3/8	38	Hex.21	21	Rc 3/8	10
4TPF-HP	R 1/2	47.5	Hex.29	26.5	Rc 1/2	13

### Socket TSF type (Female thread)

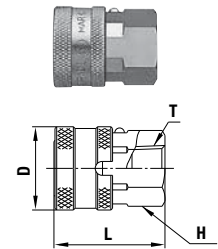

Model	Application (Thread)	Dimensions (mm)			
		L	øD	H(WAF)	T
2TSF-HP	R 1/4	32	24	Hex.19	Rc 1/4
3TSF-HP	R 3/8	35	28	Hex.23	Rc 3/8
4TSF-HP	R 1/2	44.5	35	Hex.29	Rc 1/2

### Plug TPM type (Male thread)

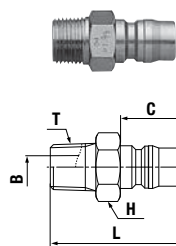

Model	Application (Thread)	Dimensions (mm)				
		L	H(WAF)	C	T	øB
2TPM-HP	Rc 1/4	38	Hex.17	18	R 1/4	6.5
3TPM-HP	Rc 3/8	43	Hex.19	21	R 3/8	10

### ⚠ Precautions for use

#### ⚠ Warning

Do not connect with standard TSP CUPLA (Page 77 to 80).

# HIGH FLOW CUPLA

For Medium Pressure

Working pressure



1.0 MPa  
{10 kgf/cm<sup>2</sup>}

Valve structure



Two-way shut-off

Applicable fluids



Water



Temperature control refrigerant

Drastically increases flow volume while minimizing pressure drop.

- Both socket and plug have built-in automatic shut-off valves.
- High flow rate type to increase cooling effect.
- Quick connection and disconnection of cooling pipes.
- Compact and space-saving design. Compared with the coupled length of SP CUPLA type A, that of HIGH FLOW CUPLA is reduced by 22%.
- Installation and maintenance can be done within a short time.

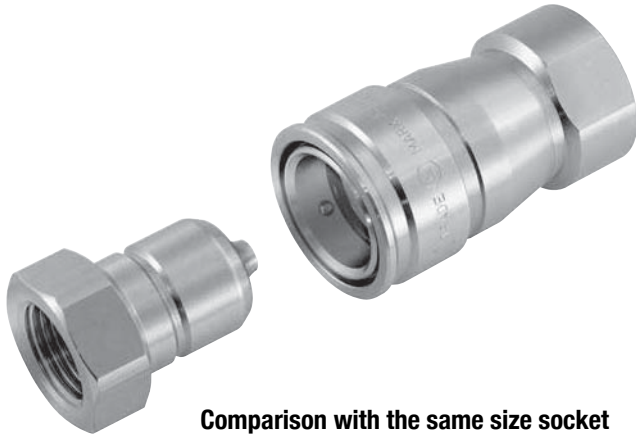

Comparison with the same size socket

Reduced

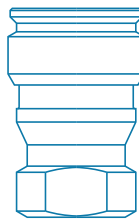

HIGH FLOW CUPLA  
HFL-4S

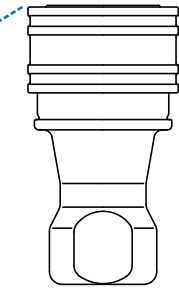

SP CUPLA Type A  
4S-A

## Specifications

Body material	Stainless steel, Brass			
Size (Thread)	1/4", 3/8", 1/2"			
Pressure unit	MPa	kgf/cm <sup>2</sup>	bar	PSI
Working pressure	1.0	10	10	145
Seal material Working temperature range	Seal material	Mark		Working temperature range
	Ethylene-propylene rubber	EPDM		-40°C to +150°C
	Fluoro rubber	FKM		-20°C to +180°C

\* Standard seal material is fluoro rubber for brass body.

## Maximum Tightening Torque

Nm {kgf·cm}

Model		HFL-2P / HFL-2S	HFL-3P / HFL-3S	HFL-4P / HFL-4S
		Torque	14 {143}	22 {224}
	Stainless steel			
	Brass	9 {92}	12 {122}	30 {306}

## Flow Direction

Fluid flow can be bi-directional when socket and plug are connected.



## Interchangeability

Socket and plug of different sizes cannot be connected.

## Minimum Cross-Sectional Area

(mm<sup>2</sup>)

Model	HFL-2P / HFL-2S	HFL-3P / HFL-3S	HFL-4P / HFL-4S
Minimum Cross-Sectional Area	32	53	91

## Suitability for Vacuum

1.3 x 10<sup>-1</sup> Pa {1 x 10<sup>-3</sup> mmHg}

Socket only	Plug only	When connected
—	—	Operational

## Flow Rate – Pressure Loss Characteristics

[Test conditions] • Fluid : Water • Temperature : 20°C±5°C

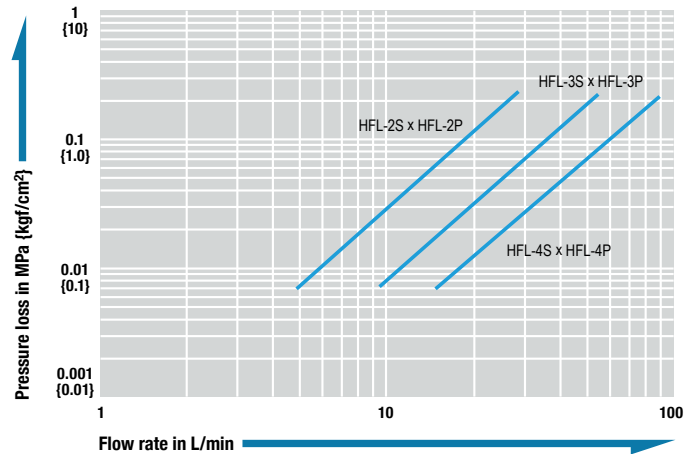

## Models and Dimensions

WAF : WAF stands for width across flats.

### Plug Female thread

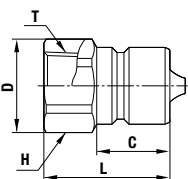

Model	Application (Thread)	Mass (g)		Dimensions (mm)				
		Brass	Stainless steel	L	C	øD	H(WAF)	T
HFL-2P	R 1/4	31	28	30	16.5	18.5	Hex.17	Rc 1/4
HFL-3P	R 3/8	47	43	31	18	23	Hex.21	Rc 3/8
HFL-4P	R 1/2	91	82	37.5	22.5	32	Hex.29	Rc 1/2

### Socket Female thread

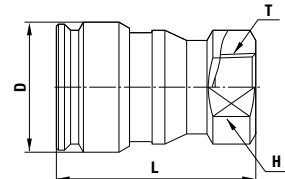



Model	Application (Thread)	Mass (g)		Dimensions (mm)			
		Brass	Stainless steel	L	øD	H(WAF)	T
HFL-2S	R 1/4	110	99	(47)	26	19	Rc 1/4
HFL-3S	R 3/8	165	150	(49)	32	24	Rc 3/8
HFL-4S	R 1/2	231	211	60	35	29	Rc 1/2

Before use, please be sure to read "Safety Guide" described at the end of this book and "Instruction Sheet" that comes with the products.

# HIGH FLOW CUPLA BI Type

CUPLA with ferrule flange for piping of water and fluids for temperature control

<p>Working pressure</p>  <p>1.0 MPa (10 kgf/cm<sup>2</sup>)</p>	<p>Valve structure</p>  <p>Two-way shut-off</p>	<p>Applicable fluids</p>  <p>Water Temperature control refrigerant</p>
--	--	---

**HIGH FLOW CUPLA and ferrule flange are combined to achieve efficient piping.**

- Easy connection with stainless steel pipe.
- Connection to plastic hose is possible with optional hose connection kit.
- Connection to various tubes is also possible via the use of appropriate optional inserts.

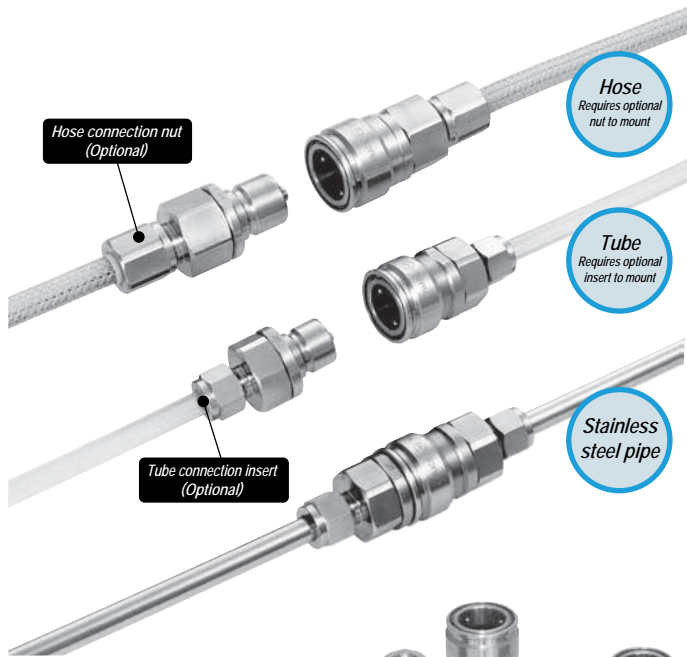

Specifications				
Body material	Stainless steel			
Applicable pipe size	1/4", 3/8", 1/2" (See the below list for hose and tube size.)			
Pressure unit	MPa	kgf/cm <sup>2</sup>	bar	PSI
Working pressure	1.0	10	10	145
Seal material	Seal material	Mark	Working temperature range	Remarks
	Ethylene-propylene rubber	EPDM	-40 °C to +150 °C	Standard material
Working temperature range	Fluoro rubber	FKM	-20 °C to +180 °C	Made-to-order item

**Flow Direction**

Fluid flow can be bi-directional when socket and plug are connected.

**Interchangeability**

Socket and plug of different sizes cannot be connected.

Suitability for Vacuum			1.3 x 10 <sup>-1</sup> Pa (1 x 10 <sup>-3</sup> mmHg)
Socket only	Plug only	When connected	Operational
—	—	Operational	

**Flow Rate – Pressure Loss Characteristics (When connected to stainless steel pipe)**

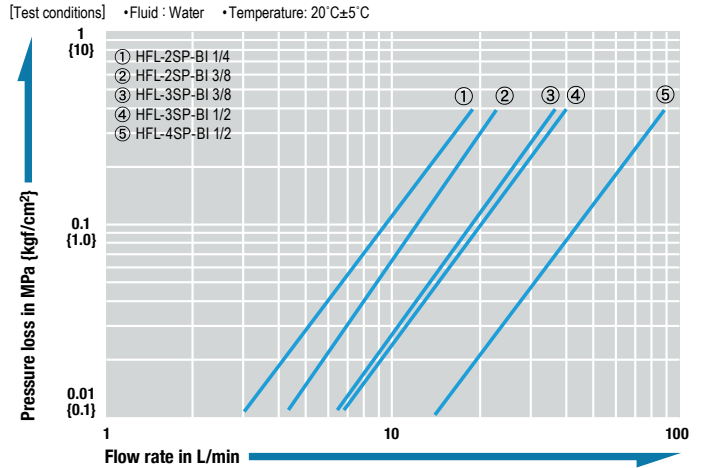

**Stainless steel pipe, hose, and tube size**

Model	Stainless steel pipe	Hose connection nut (Optional)	Tube connection insert (Optional)						
	Pipe dia. Inch (mm)	Model	Hose size (ID x OD) mm	Type of insert	Tube dimensions (ID x OD) mm	Insert dimensions			
						E (mm)	L (mm)	A (mm)	D (mm)
HFL-2SP-BI 1/4	1/4 (ø6.35)	—	—	DTI 4-2	ø3.18 x ø6.35	2.3	11.9	6.35	3.18
				DTI 4-2.5	ø3.97 x ø6.35	2.7	11.9	6.35	3.97
				DTI 4-2.75	ø4.32 x ø6.35	2.7	11.9	6.35	4.32
				DTI 4-3	ø4.76 x ø6.35	3.5	11.9	6.35	4.76
HFL-2SP-BI 3/8	3/8 (ø9.53)	—	—	DTI 6-3	ø4.76 x ø9.53	3.0	14.3	9.53	4.76
				DTI 6-4	ø6.35 x ø9.53	4.8	14.3	9.53	6.35
HFL-3SP-BI 3/8	3/8 (ø9.53)	—	—	DTI 6-3	ø4.76 x ø9.53	3.0	14.3	9.53	4.76
				DTI 6-4	ø6.35 x ø9.53	4.8	14.3	9.53	6.35
HFL-3SP-BI 1/2	1/2 (ø12.7)	E1-6 x 11	ø6 x ø11	DTI 8-4	ø6.35 x ø12.7	4.8	19.1	12.7	6.35
				DTI 8-6	ø9.53 x ø12.7	7.9	19.1	12.7	9.53
HFL-4SP-BI 1/2	1/2 (ø12.7)	E1-8 x 11	ø8 x ø11	DTI 8-4	ø6.35 x ø12.7	4.8	19.1	12.7	6.35
				DTI 8-6	ø9.53 x ø12.7	7.9	19.1	12.7	9.53

Note: The material of tube to be applied must be any of nylon, polyester, polypropylene, or Teflon. The nut for stainless steel pipe comes with standard HIGH FLOW CUPLA. When a hose or tube is connected to the CUPLA, an optional hose connection nut or tube connection insert is required.

**Models and Dimensions**

**Plug For pipe connection**

Model	Application (Pipe size) (mm)	Mass (g)	Dimensions (mm)						
			L	C	A	øD	øB	H(WAF)	T(WAF)
HFL-2P-BI 1/4	6.35 (1/4")	66	(51.9)	16.5	(15.4)	23	(6.35)	Hex.20.64 (13/16")	Hex.14.29 (9/16")
HFL-2P-BI 3/8	9.53 (3/8")	74	(53.4)	16.5	(17)	23	(9.53)	Hex.20.64 (13/16")	Hex.17.46 (11/16")
HFL-3P-BI 3/8	9.53 (3/8")	109	(54.8)	18	(17)	29.5	(9.53)	Hex.26.99 (1 1/16")	Hex.17.46 (11/16")
HFL-3P-BI 1/2	12.7 (1/2")	134	(59)	18	(23)	29.5	(12.7)	Hex.26.99 (1 1/16")	Hex.22.23 (7/8")
HFL-4P-BI 1/2	12.7 (1/2")	160	(68.7)	22.5	(23)	32	(12.7)	Hex.28.58 (1 1/8")	Hex.22.23 (7/8")

Before use, please be sure to read "Safety Guide" described at the end of this book and "Instruction Sheet" that comes with the products.

**Socket For pipe connection**

Model	Application (Pipe size) (mm)	Mass (g)	Dimensions (mm)						
			L	A	øD	øB	H(WAF)	T(WAF)	
HFL-2S-BI 1/4	6.35 (1/4")	97	(54.9)	(15.4)	26	(6.35)	Hex.20.64 (13/16")	Hex.14.29 (9/16")	
HFL-2S-BI 3/8	9.53 (3/8")	105	(56.5)	(17)	26	(9.53)	Hex.20.64 (13/16")	Hex.17.46 (11/16")	
HFL-3S-BI 3/8	9.53 (3/8")	165	(60.3)	(17)	32	(9.53)	Hex.26.99 (1 1/16")	Hex.17.46 (11/16")	
HFL-3S-BI 1/2	12.7 (1/2")	189	(64.6)	(23)	32	(12.7)	Hex.26.99 (1 1/16")	Hex.22.23 (7/8")	
HFL-4S-BI 1/2	12.7 (1/2")	233	(73.2)	(23)	35	(12.7)	Hex.28.58 (1 1/8")	Hex.22.23 (7/8")	



# SP CUPLA Type A PV Type

For Medium Pressure / Connectable with residual pressure With Purge Valve

Working pressure  
2.0 to 4.5  
2.0 to 4.5 MPa  
(20 to 46 kgf/cm<sup>2</sup>)

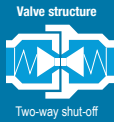

Two-way shut-off

Water

Hydraulic oil

## Equipped with residual pressure eliminating valve (up to 1 MPa).

- Automatic shut-off valves in both socket and plug prevent fluid spill out on disconnection.
- Smooth connection even when there is residual pressure when connecting.
- No residual pressure eliminating operation required on your piping. Just connect to purge the remaining pressure.



### Suitability for Vacuum $1.3 \times 10^{-1}$ Pa { $1 \times 10^{-3}$ mmHg }

Socket only	Plug only	When connected
—	—	Operational

### Admixture of Air on Connection May vary depending upon the usage conditions. (mL)

Model	6S-A-PV X 6P-A	6P-A-PV X 6S-A	8S-A-PV X 8P-A	8P-A-PV X 8S-A	10S-A-PV X 10P-A	10P-A-PV X 10S-A	12S-A-PV X 12P-A	12P-A-PV X 12S-A
Volume of air	11		17		29		45	

### Volume of Spillage per Disconnection May vary depending upon the usage conditions. (mL)

Model	6S-A-PV X 6P-A	6P-A-PV X 6S-A	8S-A-PV X 8P-A	8P-A-PV X 8S-A	10S-A-PV X 10P-A	10P-A-PV X 10S-A	12S-A-PV X 12P-A	12P-A-PV X 12S-A
Volume of spillage	8.4		12		26		36	

### Models and Dimensions

Model	Application (Thread)	Mass (g)		Dimensions (mm)			
		Brass	Stainless steel	L	C	H (WAF)	T
6P-A-PV	R 3/4	204	189	52	36	Hex.35	Rc 3/4
8P-A-PV	R 1	330	307	62	40	Hex.41	Rc 1
10P-A-PV	R 1 1/4	627	617	70	45	Hex.54 (*1)	Rc 1 1/4
12P-A-PV	R 1 1/2	917	877	75	49	Hex.63 (*2)	Rc 1 1/2

(\*1) Stainless steel: WAF 54 x ø59 (\*2) Stainless steel: WAF 63 x ø68

### Specifications

Body material		Brass, Stainless steel (SUS304)							
Model	6S-A-PV	6P-A-PV	8S-A-PV	8P-A-PV	10S-A-PV	10P-A-PV	12S-A-PV	12P-A-PV	
	Socket	Plug	Socket	Plug	Socket	Plug	Socket	Plug	
Size (Thread)		Rc 3/4		Rc 1		Rc 1 1/4		Rc 1 1/2	
Working pressure	Brass	MPa	3.0				2.0		
		kgf/cm <sup>2</sup>	31				20		
		bar	30				20		
	PSI	435				290			
	Stainless steel	MPa	4.5				3.0		
		kgf/cm <sup>2</sup>	46				31		
bar		45				30			
PSI	653				435				
Connectable residual pressure*		1.0 MPa, 10 kgf/cm <sup>2</sup> , 10 bar, 145 PSI							
Seal material		Nitrile rubber		Mark		Working temperature range		Remarks	
Seal material		Nitrile rubber		Mark		Working temperature range		Remarks	
Seal material		Nitrile rubber		Mark		Working temperature range		Remarks	

\* The allowable residual pressure that can be connected when the fluid is limited to liquid.

### Maximum Tightening Torque Nm (kgf·cm)

Size (Thread)	Nm (kgf·cm)				
	Rc 3/4	Rc 1	Rc 1 1/4	Rc 1 1/2	
Torque	Brass	50 {510}	65 {663}	150 {1530}	180 {1836}
	Stainless steel	90 {918}	120 {1224}	260 {2652}	280 {2856}

### Flow Direction

Fluid flow can be bi-directional when socket and plug are connected.



### Interchangeability

Socket and plug of different sizes cannot be connected. Can be connected with SP CUPLA Type A AND SP-V CUPLA of the same size. Refrain from connecting SP CUPLA Type A PV together, since the residual pressure will not release.

### Minimum Cross-Sectional Area (mm<sup>2</sup>)

Model	6S-A-PV X 6P-A	6P-A-PV X 6S-A	8S-A-PV X 8P-A	8P-A-PV X 8S-A	10S-A-PV X 10P-A	10P-A-PV X 10S-A	12S-A-PV X 12P-A	12P-A-PV X 12S-A
Min. Cross-Sectional Area	178		229		395		553	

### Flow Rate – Pressure Loss Characteristics

[Test conditions] • Fluid : Water • Temperature : 25°C±5°C

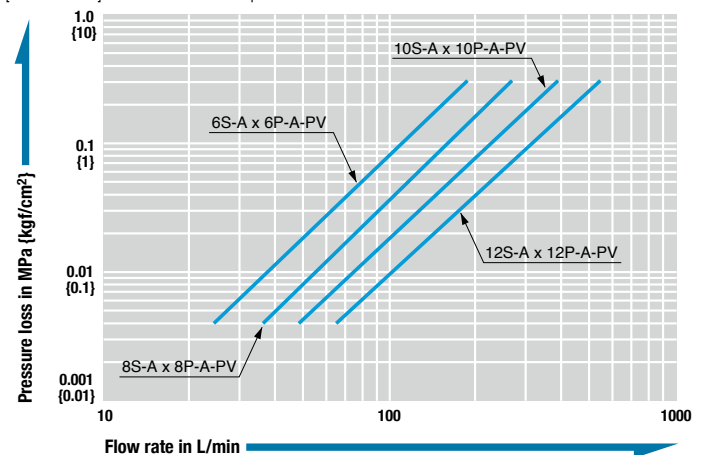

WAF : WAF stands for width across flats.

Model	Application (Thread)	Mass (g)		Dimensions (mm)			
		Brass	Stainless steel	L	øD	H (WAF)	T
6S-A-PV	R 3/4	685	644	88	55	WAF 35	Rc 3/4
8S-A-PV	R 1	1021	959	102	65	WAF 41	Rc 1
10S-A-PV	R 1 1/4	1517	1437	115	77	WAF 54	Rc 1 1/4
12S-A-PV	R 1 1/2	2267	2147	124	88	WAF 63	Rc 1 1/2

**Safety Guide:** This product can be connected under residual pressure, but do not connect under dynamic pressure applied. It may lead to incomplete connection, deteriorated durability or possible valve fly out. Read without fail and observe the "Instruction sheet" that comes with the product and the following pages in the general Quick Connect Coupling Catalog; [Precautions Relating to the Use of All CUPLA] and "CUPLA for Low Pressure (Water, Liquid) and for Medium Pressure" in the [Safety Guide] page.

# PLASTIC CUPLA BC Type Valveless

For low pressure air piping

Working pressure

**0.07**

0.07 MPa  
(0.7 kgf/cm<sup>2</sup>)

Valve structure



Straight through

Applicable fluid



Air

- To connect, just push the plug into the socket.
- Plastic makes this ideal for use in environment prone to rusting.
- Compact and light weight for easy handling.
- Valveless construction gives more stable flow.



Before use, please be sure to read "Safety Guide" described at the end of this book and "Instruction Sheet" that comes with the products.

# PLASTIC CUPLA BCC Type with Flow Controller

For low pressure air piping

Working pressure

**0.07**

0.07 MPa  
(0.7 kgf/cm<sup>2</sup>)

Valve structure



One-way shut-off

Applicable fluid



Air

- To connect, just push the plug into the socket.
- Plug with built-in automatic shut-off valve.
- Socket with handy flow controller.
- Plastic makes this ideal for use in environments prone to rusting.
- Compact and light weight for excellent handling.



Before use, please be sure to read "Safety Guide" described at the end of this book and "Instruction Sheet" that comes with the products.

## Specifications

Body material	Plastic			
Size	1/4", 3/8" hose			
Pressure unit	MPa	kgf/cm <sup>2</sup>	bar	PSI
Working pressure	0.07	0.7	0.7	10.2
Seal material	Seal material	Mark	Working temperature range	Remarks
Working temperature range	Nitrile rubber	NBR (SG)	-20°C to +50°C	Standard material

## Models and Dimensions

WAF : WAF stands for width across flats.

### Plug PH type (Hose barb)

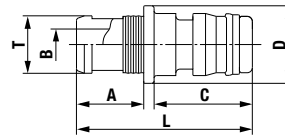

Model	Application (Hose)	Mass (g)	Dimensions (mm)					
			L	C	A	øB	øT	øD
BC-2PH	1/4"	1.8	41	19	17	4	8.5	14
BC-3PH	3/8"	2	34	19	13	6	10.9	15

### Socket SH type (Hose barb)

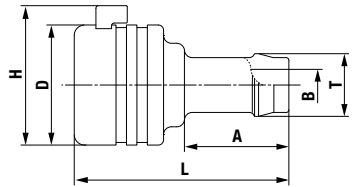
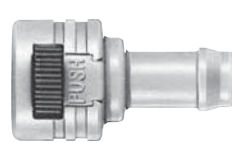

Model	Application (Hose)	Mass (g)	Dimensions (mm)					
			L	A	øB	øT	øD	H
BC-2SH	1/4"	5.6	38	17	4	8.5	23	(26.5)
BC-3SH	3/8"	6	41	20	6	12	23	(26.5)

## Specifications

Body material	Plastic			
Size	3/8" hose			
Pressure unit	MPa	kgf/cm <sup>2</sup>	bar	PSI
Working pressure	0.07	0.7	0.7	10.2
Seal material	Seal material	Mark	Working temperature range	Remarks
Working temperature range	Nitrile rubber	NBR (SG)	-20°C to +50°C	Standard material

## Models and Dimensions

WAF : WAF stands for width across flats.

### Plug PH type (Hose barb)

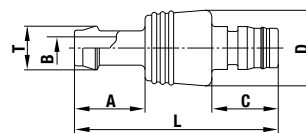

Model	Application (Hose)	Mass (g)	Dimensions (mm)					
			L	C	A	øD	øT	øB
BCV-3PH	3/8"	10	(58)	19	20	21	12	6

### Socket SH type (Hose barb)

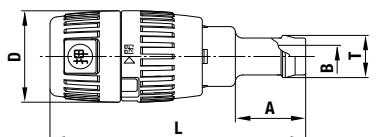

Model	Application (Hose)	Mass (g)	Dimensions (mm)				
			L	øD	A	øT	øB
BCV-3SH	3/8"	25	(73)	26	20	12	6

Before use, please be sure to read "Safety Guide" described at the end of this book and "Instruction Sheet" that comes with the products.

## DIP MOLD DUST CAP

Dust caps for HI CUPLA, SP CUPLA Type A, TSP CUPLA, and HYDRAULIC CUPLA

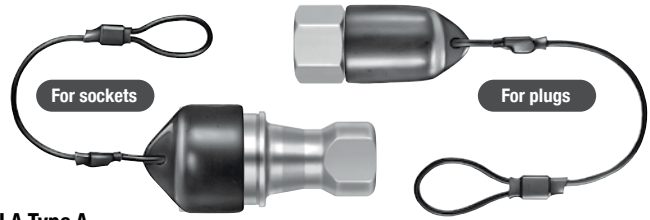

- PVC Dust Caps produced by dip molding are available for HI CUPLA, SP CUPLA Type A, TSP CUPLA, and HYDRAULIC CUPLA. Dust Caps prevent dust from getting inside the fluid line and protects the sealability and life of the O-ring.

Caution: The function of the cap may be damaged due to fluid adhering to the CUPLA or due to the external environment. Wipe off the fluid from the CUPLA to prevent the fluid from adhering.

	Part number	Cap for HI CUPLA	Sales unit
Socket	CA96462	For 20 type	1
		For 30 type	1
		For 40 type	1
Socket	CA96464	For 400 type	1
		For 600 type	1
		For 800 type	1
Plug	CA96453	For 20 type	1
		For 30 type	1
		For 40 type	1
Plug	CA96455	For 400 type	1
		For 600 type	1
		For 800 type	1

	Part number	Cap for 700R CUPLA	Sales unit
Socket	CB00614	For 700R-3S	1
	CA82644	For 700R-4S	1
Plug	CA83164	For 700R-3P	1
	CA82643	For 700R-4P	1

	Part number	Cap for SP CUPLA Type A	Sales unit
Socket	CA96462	For 1S-A	1
	CA96463	For 2S-A	1
	CA96464	For 3S-A	1
	CA96465	For 4S-A	1
	CA96466	For 6S-A	1
	CA96467	For 8S-A	1
	CA96468	For 10S-A	1
	CA96449	For 12S-A	1
	CA96470	For 16S-A	1
	Plug	CA96453	For 1P-A
CA96454		For 2P-A	1
CA96455		For 3P-A	1
CA96456		For 4P-A	1
CA96457		For 6P-A	1
CA96458		For 8P-A	1
CA96459		For 10P-A	1
CA96460		For 12P-A	1
CA96461		For 16P-A	1

	Part number	Cap for TSP CUPLA	Sales unit
Socket	CA96542	For 1TS	1
	CA96462	For 2TS	1
	CA96463	For 3TS	1
	CA96464	For 4TS	1
	CA96465	For 6TS	1
	CA96479	For 8TS	1
	CA96553	For 10TS	1
	CA96555	For 12TS	1
	CA96557	For 16TS	1
	Plug	CA96541	For 1TP
CA96453		For 2TP	1
CA96454		For 3TP	1
CA96455		For 4TP	1
CA96456		For 6TP	1
CA96551		For 8TP	1
CA96552		For 10TP	1
CA96459		For 12TP	1
CA96556		For 16TP	1

	Part number	Cap for HSP CUPLA	Sales unit
Socket	CA96463	For 2HS	1
	CA96476	For 3HS	1
	CA96477	For 4HS	1
	CA96477	For 6HS	1
	CA96478	For 66HS	1
	CA96479	For 8HS	1
	CA96481	For 10HS	1
	CA96481	For 12HS	1
	CA96482	For 16HS	1
	Plug	CA96454	For 2HP
CA96455		For 3HP	1
CA96456		For 4HP	1
CA96456		For 6HP	1
CA96471		For 66HP	1
CA96472		For 8HP	1
CA96473		For 10HP	1
CA96473		For 12HP	1
CA96475		For 16HP	1

	Part number	Cap for 210 CUPLA	Sales unit
Socket	CA96463	For 210-2S	1
	CA96476	For 210-3S	1
	CA81555	For 210-4S	1
	CA96478	For 210-6S	1
	CA96466	For 210-8S	1
Plug	CA96454	For 210-2P	1
	CA96455	For 210-3P	1
	CA82643	For 210-4P	1
	CA96471	For 210-6P	1
	CA96551	For 210-8P	1

	Part number	Cap for 280 CUPLA	Sales unit
Socket	CB17082	For 280-2S	1
	CA96476	For 280-3S	1
	CA81555	For 280-4S	1
	CA96478	For 280-6S	1
	CA96466	For 280-8S	1
	Plug	CA96453	For 280-2P
CA96455		For 280-3P	1
CA82643		For 280-4P	1
CA96471		For 280-6P	1
CA96551		For 280-8P	1

	Part number	Cap for F35/350 CUPLA	Sales unit	
Socket	CB28313	For F35-2S	1	
	CA81551	For F35/350-3S	1	
	CA81555	For F35/350-4S	1	
	CA97213	For F35/350-6S	1	
	CA80401	For F35/350-8S	1	
	Plug	CA96454	For F35-2P	1
		CA81553	For F35/350-3P	1
		CA81557	For F35/350-4P	1
		CA97215	For F35/350-6P	1
		CA80402	For F35/350-8P	1

	Part number	Cap for ZEROSPILL CUPLA	Sales unit
Socket	CA96463	For ZEL-2S	1
	CA96464	For ZEL-3S	1
	CB28786	For ZEL-4S	1
	CA96466	For ZEL-6S	1
	CA96467	For ZEL-8S	1
	Plug	CA96454	For ZEL-2P
CB28790		For ZEL-3P	1
CA96456		For ZEL-4P	1
CA96457		For ZEL-6P	1
CA96472		For ZEL-8P	1

	Part number	Cap for HSU CUPLA	Sales unit
Socket	CA96463	For HSU-2S	1
	CA96464	For HSU-3S	1
	CA96465	For HSU-4S	1
	CA96466	For HSU-6S	1
	CA96467	For HSU-8S	1
Plug	CB60672	For HSU-2P	1
	CB60673	For HSU-3P	1
	CB60674	For HSU-4P	1
	CB60675	For HSU-6P	1
	CB60676	For HSU-8P	1



Size-adjustable Ring for Dip Mold Cap

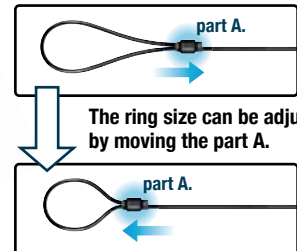

- Metal Cap equipped with dust-proof and leak prevention function.
- Caps with metal material corresponding to that of CUPLA body are available.

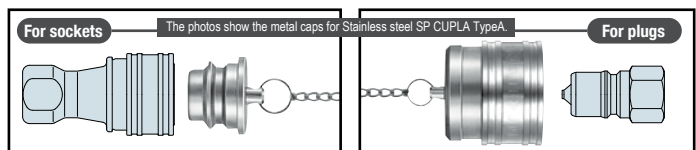

## SAFETY CAP

Metal caps for HI CUPLA Series, SP CUPLA Type A, TSP CUPLA and HYDRAULIC CUPLA

(Semi-standard)

Model	Applicable CUPLA	Sales unit
<p>Model name of Safety Cap is stated in the following manner.</p> <p><b>Model= CUPLA Model (normal CUPLA) + SD (safety cap)</b></p> <p>Example: "2S-A-SD" identifies a safety cap for SP CUPLA Type A Model 2S-A.</p>	<p>Sockets and plugs for HI CUPLA, SP CUPLA Type A, TSP CUPLA, HSP CUPLA, 210 CUPLA, S210 CUPLA, 350 CUPLA, 450B CUPLA and SP-V CUPLA</p>	1 pc.

# DUST CAP

Plastic Cap for HI CUPLA Series



See page 149 for the details of Dip MOLD DUST CAP and SAFETY CAP for HI CUPLA.

- Dust caps prevent dust from getting inside CUPLA.

Part number	Model	Applicable CUPLA	Sales unit	Material
CQ12434	20S-D	Sockets for 20/30/40 type HI CUPLA Series <small>Note: Dust caps cannot be attached to the sockets for FULL- BLOW CUPLA, 400/600/800 type of HI CUPLA and HI CUPLAACE.</small>	1	Polyvinyl chloride (PVC)

# DUST CAP

Dedicated polyethylene cap for HYGIENIC CUPLA

- Dust cap for both plug and socket (made of polyethylene).

The Dust Cap conforms to No. 3-D-2-(1) and 3-D-2-(2)-4 Apparatus and Containers/Packages. It has passed both material and elution tests specified in the standards for Food and Food additives. (Notice No.201 of revised March 31, 2006 by the Ministry of Health and Welfare of Japan)

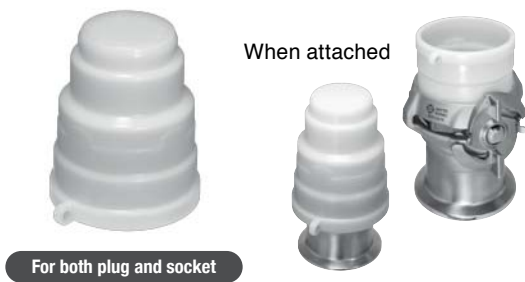

Model	Size	Applicable CUPLA	Sales unit	Material
SEW-1.5SP-D	1.5S	For HYGIENIC CUPLA Plug and Socket	1	Polyvinyl chloride (HDPE)
SEW-2.0SP-D	2.0S		1	

# SLEEVE COVER

Plastic cover for HI CUPLA Series (5 pcs. per package)

- Easier sliding operation is achieved by attaching an additional plastic cover over the socket sleeve of HI CUPLA Series.
- Plastic covers reduce the risk of damage if the CUPLA strikes other components or products.
- Sleeve covers in various colors allow for easier identification of various air lines.



The SLEEVE COVER cannot be used together with the DUST CAP or DIP MOLD DUST CAP.

Part number	Model	Color	Applicable CUPLA	Sales unit	Material
CB23588	SLC-HI-R	Red	For HI CUPLA Series Sockets <small>Note: Sleeve covers cannot be attached to sockets for the FULL-BLOW CUPLA, 400/600/800 HI CUPLA, HI CUPLA ACE, Stainless HI CUPLA and Brass HI CUPLA.</small>	5	Thermoplastic elastomer (TPE)
CB23590	SLC-HI-B	Blue		5	
CB23589	SLC-HI-Y	Yellow		5	
CB23591	SLC-HI-W	White		5	
CB23587	SLC-HI-K	Black		5	

# PROTECTION COVER

Plastic Cover for NUT CUPLA and FULL-BLOW CUPLA Nut Type (Semitransparent)

- For NUT CUPLA and FULL-BLOW CUPLA Nut Type.
- Protection cover wraps up the whole CUPLA to absorb impacts and to reduce the risk of damage if the CUPLA accidentally strikes other components or products.
- Protection covers can be cut to fit the hose diameter which the CUPLA is connected to.
- Can be attached to either the socket or the plug, and can be used as a dust cap.

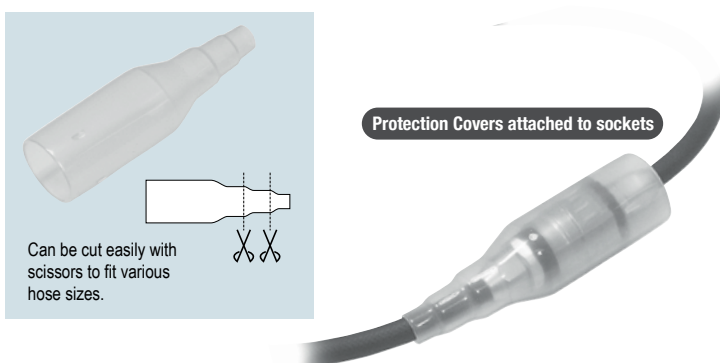

Part number	Model	Applicable CUPLA	Sales unit	Material
CB23784	SOC-HI	Can be attached to NUT CUPLA socket or plug (SN type & PN type) and the FULL-BLOW CUPLA socket (SN Type).	1	Polyvinyl chloride (PVC)



# ACCESSORIES FOR AIR LINES

Air Line accessories for HI CUPLA series

- Connects directly to 20/30/40 type HI CUPLA sockets.
- Convenient to control drainage and pressure in air lines.



Part number	Model	CUPLA that accessories can be mounted on	Sales unit	Description
CB23625	DC-30PF	HI CUPLA sockets	1	DRAIN COCK
CB11253	PG-10P	HI CUPLA sockets	1	PRESSURE GAUGE

# SLEEVE STOPPER

Sleeve Stopper for SP CUPLA Type A

- Sleeve stopper exclusively for SP CUPLA Type A sockets. Attaching the sleeve stopper after connection of socket and plug locks the sleeve of the socket and prevents unexpected disconnection.

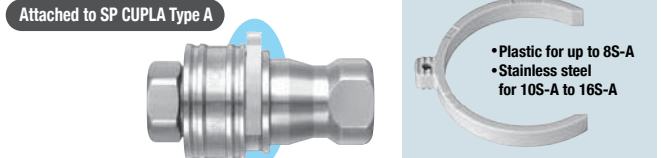

	Part number	Stopper for SP CUPLA Type A socket	Applicable CUPLA	Sales unit	Material		Part number	Stopper for SP CUPLA Type A socket	Applicable CUPLA	Sales unit	Material
Socket	CB24350	For 1S-A	SP CUPLA Type A sockets	10	Engineering plastics (POM)	Socket	CB26456	For 10S-A	SP CUPLA Type A sockets	1	SUS 304
	CB24351	For 2S-A		10			CB26457	For 12S-A		1	
	CB24352	For 3S-A		10			CB26458	For 16S-A		1	
	CB24353	For 4S-A		10							
	CB24354	For 6S-A		10							
	CB24355	For 8S-A		10							

# ACCESSORIES FOR O-RING MAINTENANCE

Jigs & grease for replacement of O-rings for couplings  
For SP CUPLA Type A, TSP CUPLA, HOT WATER CUPLA, ZEROSPILL CUPLA, HSP CUPLA, HSU CUPLA and HYGIENIC CUPLA

- The seal materials play an important role in maintaining the performance of a coupling. O-rings or seal materials of these CUPLA series are designed to be replaceable. Please be certain to choose the correct and genuine Nitto kohki O-ring in order to maintain the performance of couplings.

Jig for O-ring replacement

- Model: **PMJ-1 (Small)**  
(Part.No.CB23687)  
• Sales unit: 1 pc.
- Model: **PMJ-2 (Large)**  
(Part.No.CB23688)  
• Sales unit: 1 pc.

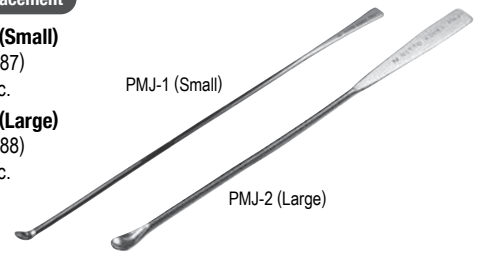

5mL container

**Grease for CUPLA**

- **GRE-HC1** (Hydrocarbon grease) for NBR, FKM O-ring or packing (Part.No.CB28531)  
• Sales unit: 1 pc.

5mL container

**Grease for CUPLA**

- **GRE-M1** (Mineral grease) for NBR, FKM O-ring or packing (Part.No.CB23701)  
• Sales unit: 1 pc.

5mL container

**Grease for CUPLA**

- **GRE-S1** (Silicone grease) for NBR, FKM, and EPDM O-ring or packing (Part.No.CB23702)  
• Sales unit: 1 pc.

5mL container

**Grease for CUPLA**

- **GRE-S2** (Silicone grease) for NBR, FKM, and EPDM O-ring or packing (Part.No.CB28791)  
• Sales unit: 1 pc.  
(NSF H1, NSF 61 registered product)  
Standardly applied to CUBE CUPLA

O-ring for SP CUPLA Type A	Part number			Sales unit
	NBR	FKM	EPDM	
For 1S-A	CP01314	CP00907	CP03270	1
For 2S-A	CP00927	CP00928	CP03333	1
For 3S-A	CP00955	CP00956	CP03276	1
For 4S-A	CP00978	CP00979	CP03283	1
For 6S-A	CP01003	CP01004	CP03292	1
For 8S-A	CP01029	CP01030	CP03298	1
For 10S-A	CP00398	CP01053	CP07179	1
For 12S-A	CP01076	CP01077	CP03902	1
For 16S-A	CP01099	CP01100	CP06953	1

O-ring for TSP CUPLA	Part number			Sales unit
	NBR	FKM	EPDM	
For 1TS	CP03987	CP04984	CP09795	1
For 2TS	CP01314	CP00907	CP03270	1
For 3TS	CP00927	CP00928	CP03333	1
For 4TS	CP00955	CP00956	CP03276	1
For 6TS	CP00978	CP00979	CP03283	1
For 8TS	CP00387	CP01258	CP04923	1
For 10TS	CP01273	CP01274	CP09221	1
For 12TS	CP00398	CP01053	CP07179	1
For 16TS	CP01304	CP01305	CP09794	1

O-ring for HSP CUPLA	Part number		Sales unit
	NBR	FKM	
For 2HS	CP01185	CP02215	1
For 3HS	CP01194	CP03335	1
For 4HS	CP00294	CP02093	1
For 6HS	CP00294	CP02093	1
For 66HS	CQ33388	CP25937	1
For 8HS	TP00293	CP01179	1
For 10HS	CP01516	CP03371	1
For 12HS	CP01516	CP03371	1
For 16HS	CP03035	CP03453	1

Backup ring for HSP CUPLA	Part number	Sales unit
	PTFE	
For 2HS	CP01186	1
For 3HS	CP01195	1
For 4HS	CP01203	1
For 6HS	CP01203	1
For 66HS	CP09659	1
For 8HS	CP01211	1
For 10HS	CP01517	1
For 12HS	CP01517	1
For 16HS	CP03036	1

O-ring for ZEROSPILL CUPLA	Part number			Sales unit
	NBR	FKM	EPDM	
For ZEL-2S	CQ40611	CQ40740	CQ43755	1
For ZEL-3S	CQ40628	CQ40744	CQ43757	1
For ZEL-4S	CQ40645	CQ40748	CQ43759	1
For ZEL-6S	CQ40662	CQ40752	CQ43761	1
For ZEL-8S	CQ40679	CQ40756	CQ43763	1

O-ring for HSU CUPLA	Part number	Sales unit
	HNBR	
HSU-2S	CQ42490	1
HSU-3S	CQ42496	1
HSU-4S	CQ42502	1
HSU-6S	CQ43482	1
HSU-8S	CQ43489	1

Backup ring for HSU CUPLA	Part number	Sales unit
	PTFE	
HSU-2S	CP25269	1
HSU-3S	CQ42497	1
HSU-4S	CQ13520	1
HSU-6S	CQ26486	1
HSU-8S	CP20780	1

O-ring for HOT WATER CUPLA	Part number	Sales unit
	FKM	
HW-2S-F	CB64216	2
HW-3S-F	CB64217	2
HW-4S-F	CB64218	2

O-ring for HYGIENIC CUPLA	Part number			Sales unit
	SI	FKM	EPDM	
SEW-1.5P	CB63419	CB63420	CB63421	1
SEW-2.0P	CB62939	CB62940	CB62941	1

• See page 172 for replacement of the O-ring.

# RESIDUAL PRESSURE RELEASE JIG

Residual Pressure Release Metal Jig for SP CUPLA Type A and HYDRAULIC CUPLA (Semi-standard)

- Residual pressure within socket or plug can be released easily by just turning the handle.
- Residual pressure release jigs are available in two types; socket type for use with plugs and plug type for use with sockets.
- Connection to sockets or plugs is the same as connection of normal CUPLA.

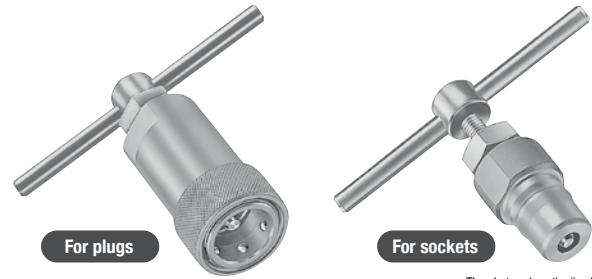

The photos show the jigs for HSP CUPLA.

Model	Attachable CUPLA	Sales unit
The model name is to be defined in the following manner. <b>Z N</b> – Type of CUPLA to be attached Residual pressure release jig	Sockets and plugs for SP CUPLA Type A, HSP CUPLA, 210 CUPLA, S210 CUPLA, 280 CUPLA and 350 CUPLA	1 pc.
Example: For the CUPLA model 350-3S, the jig name would be <b>ZN-350-3S</b>		

Caution: Since the upper limit of residual pressure that can be relieved depends on the product, please contact us separately.

# CUPLA ADAPTER for Braided Hose Connection

Mounts on CUPLA plug / socket with female thread

- Adapter for CUPLA with female thread such as ZEROSPILL CUPLA and SP CUPLA Type A.
- No hose clamp is required resulting in reduced risk of injuries to fingers or palms.
- Deterioration of the braided hose at the hose barb part has been eliminated.
- Unique nut construction increases the pulling load of braided hoses.
- Simply push a braided hose onto the hose barb to the end and tighten the nut until it is flush against the hose barb base.
- No inner parts for conventional braided hose fittings are required. Thus incorrect assembling does not occur.

A tool and a hose clamp are not required.



Not Required

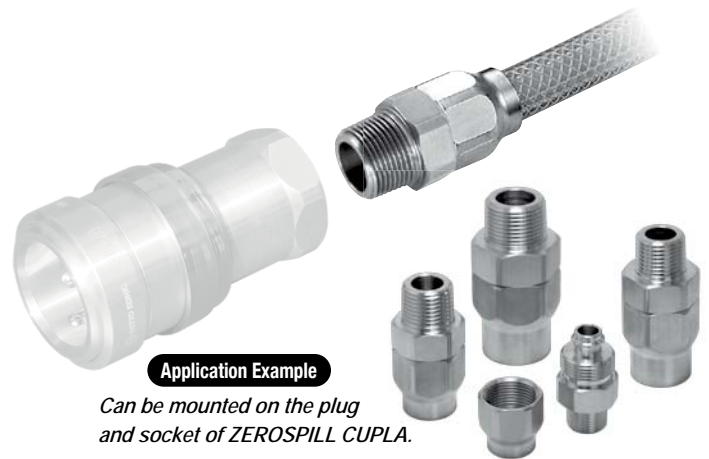

Application Example  
Can be mounted on the plug and socket of ZEROSPILL CUPLA.

Benefits without a hose clamp **Two piece design**

Please use braided hoses available in the market.

## Specifications

Body material	Brass			
Model	BH90-3M	BH120-4M	BH150-4M	BH190-6M
Size (Thread)	3/8"	1/2"	1/2"	3/4"
Braided hose size	ø9 x ø15 mm	ø12 x ø18 mm	ø15 x ø22 mm	ø19 x ø26 mm
Working pressure *1	Depends upon the specifications of braided hoses to be used.			
Working temperature range *1	Depends upon the specifications of braided hoses to be used.			
Applicable fluids *2	Air, Water, Oil			

## Maximum Tightening Torque

Nm {kgf·cm}

Model	BH90-3M	BH120-4M	BH150-4M	BH190-6M
Torque (Taper Pipe Threads) *3,4	12 {122}	30 {306}	30 {306}	50 {510}

\*1: Max working pressure and working temperature depend upon the specifications of braided hoses to be used.  
 \*2: Use within the specification of the seal material and the braided hose to be used.  
 \*3: Stress corrosion crack may happen if they are used under corrosive environment. Take note of usage conditions.  
 \*4: Tighten the nut until it is flush against the hose barb base after pushing a braided hose to the end.  
 • Braided hoses should be made of soft PVC and woven by reinforcement thread.

## Models and Dimensions

WAF: WAF stands for width across flats.

### BH-M type (Male thread)

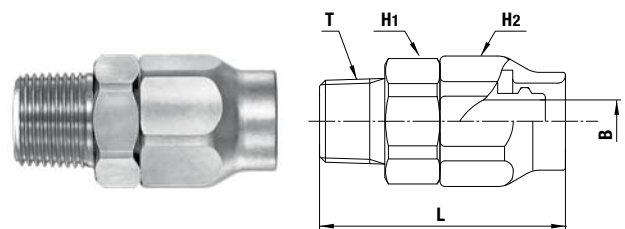

Model	Application (Hose) (mm)	Hose wall thickness (mm)	Mass (g)	Dimensions (mm)				
				L	H1 (WAF)	H2 (WAF)	T	øB
BH90-3M	ø9 x ø15	3±0.3	106	(49)	Hex.23	Hex.24	R 3/8	8.5
BH120-4M	ø12 x ø18	3±0.3	159	(59)	Hex.27	Hex.27	R 1/2	11
BH150-4M	ø15 x ø22	3.5±0.35	210	(67)	Hex.30	Hex.30	R 1/2	13
BH190-6M	ø19 x ø26	3.5±0.35	301	(74)	Hex.35	Hex.35	R 3/4	17

# PURGE ADAPTER

Residual Pressure Purge Adapter for Hydraulic Lines

**NEW**

**Just Push**

- Can be attached to hydraulic lines to purge residual pressure effectively.

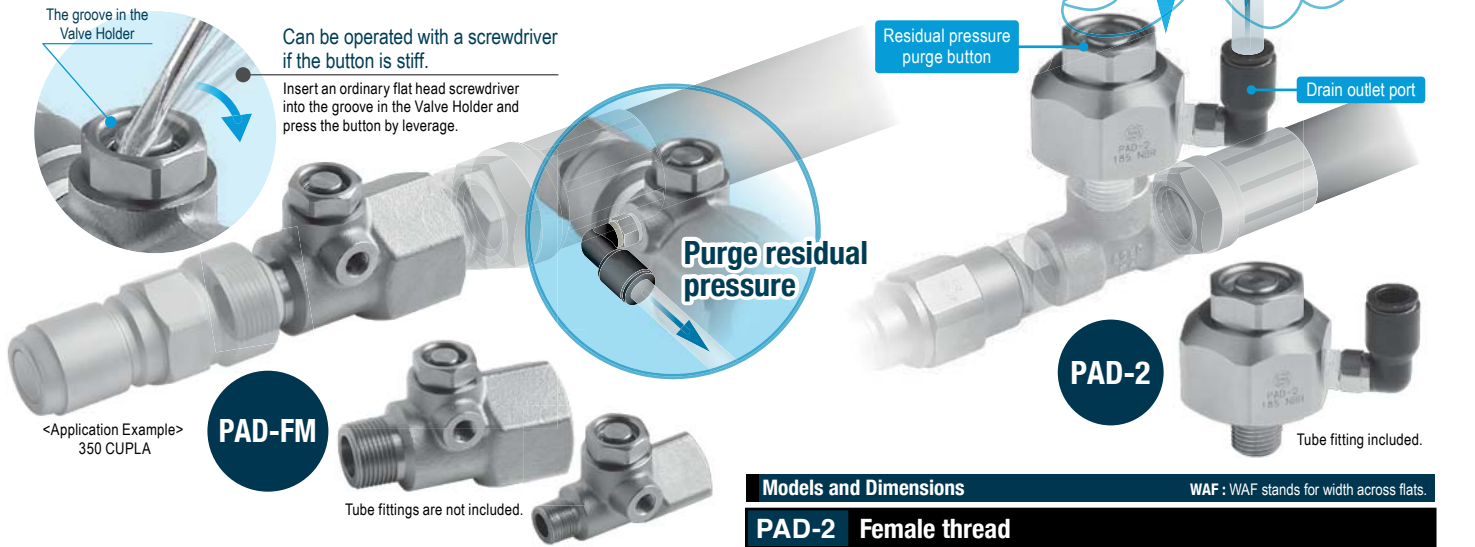

## Residual Pressure Purge Speed Comparison

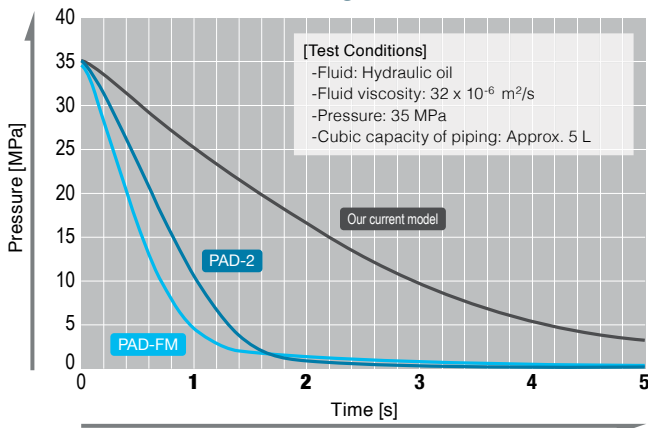

### Models and Dimensions

WAF : WAF stands for width across flats.

#### PAD-2 Female thread

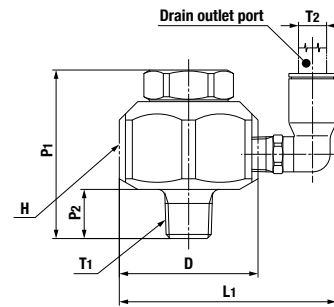

Model	Mass (g)	Dimensions (mm)						
		L1	øD	P1	P2	H (WAF)	T1	øT2
PAD-2	235	(62)	39.5	(48)	14	Hex.36	R 1/4	8

#### PAD-3FM / PAD-4FM For thread connection

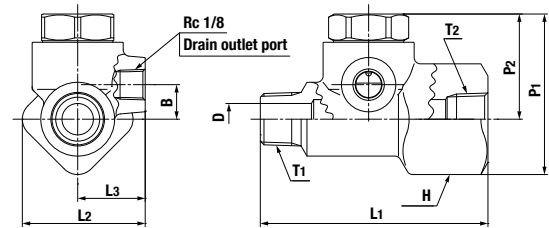

Model	Mass (g)	Dimensions (mm)									
		L1	L2	L3	B	øD	P1	P2	H (WAF)	T1	T2
PAD-3FM	320	72.5	(39)	21.5	(11)	10	(51)	(33.5)	□29	R 3/8	Rc 3/8
PAD-4FM	307	72.5	(39)	21.5	(11)	12.5	(51)	(33.5)	□29	R 1/2	Rc 1/2

#### PAD-6FM / PAD-8FM For thread connection

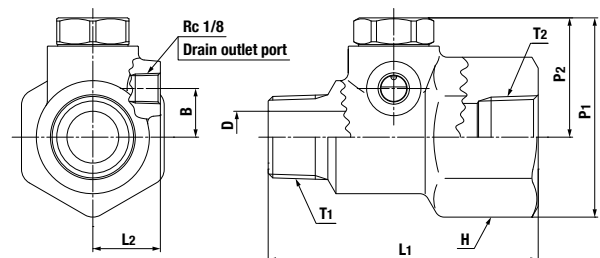

Model	Mass (g)	Dimensions (mm)									
		L1	L2	B	øD	P1	P2	H (WAF)	T1	T2	
PAD-6FM	665	86	21.5	(15.5)	16.5	(63.5)	(38)	Hex.46	R 3/4	Rc 3/4	
PAD-8FM	620	86	21.5	(15.5)	21.5	(63.5)	(38)	Hex.46	R 1	Rc 1	

Specifications					
Model	PAD-2	PAD-3FM	PAD-4FM	PAD-6FM	PAD-8FM
Body material	Steel (Nickel plated)				
Application	R 1/4	R 3/8 x Rc 3/8	R 1/2 x Rc 1/2	R 3/4 x Rc 3/4	R 1 x Rc 1
Pressure unit	MPa	kgf/cm <sup>2</sup>	bar	PSI	
Working pressure	35.0	357	350	5080	
Drain outlet port	For 8 mm OD tube	Application: Rc 1/8 (Max. Tightening Torque: 5 Nm)			
Applicable fluids	Hydraulic oil				
Seal material	Seal material	Mark	Working temperature range	Remarks	
Working temperature range	Nitrile rubber	NBR (SG)	-5°C to +80°C	Standard material	

Maximum Tightening Torque Nm (kgf·cm)					
Size (Thread)	R 1/4	R 3/8 x Rc 3/8	R 1/2 x Rc 1/2	R 3/4 x Rc 3/4	R 1 x Rc 1
Torque	28 {286}	40 {408}	80 {816}	150 {1530}	250 {2550}

Minimum Cross-Sectional Area (mm <sup>2</sup> )					
Model	PAD-2	PAD-3FM	PAD-4FM	PAD-6FM	PAD-8FM
Minimum Cross-Sectional Area	-	78.5 (ø10)	122 (ø12.5)	213 (ø16.5)	363 (ø21.5)

**Suitability for Vacuum**  
 Not suitable for vacuum application.

# CUPLA CONNECTING JIG

Connecting Jig for large CUPLA

- Smooth and easy connection of large CUPLA by operating a lever.

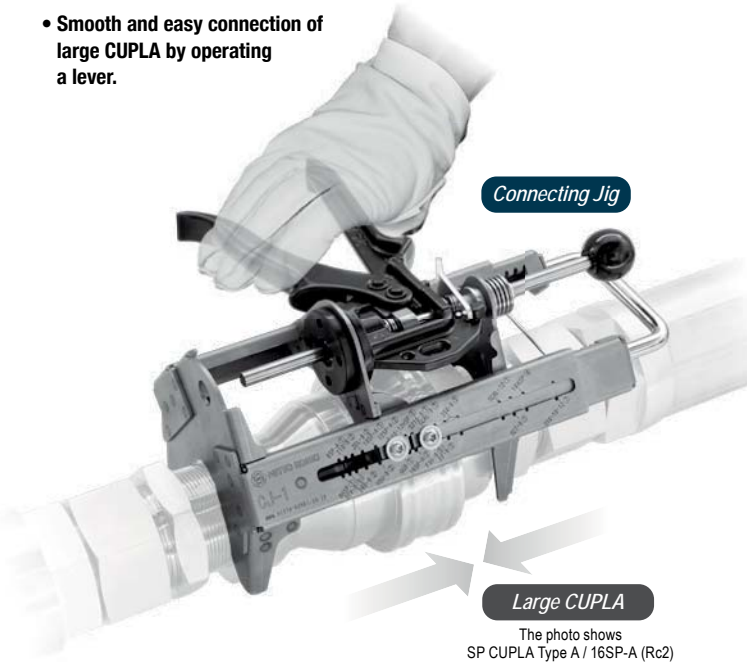

### Versatile

Corresponds to all applicable models\*1 by adjusting the body length.

\*1: Standard CUPLA appearing in the CUPLA general catalog (two-way shut-off valve). Except MULTI CUPLA series. See below list of applicable models.

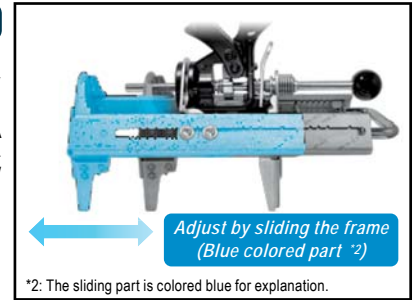

\*2: The sliding part is colored blue for explanation.

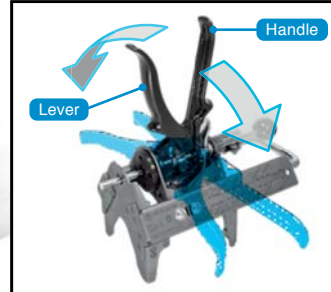

### Functional

The Handle can be used at any angle to prevent interference with the CUPLA.

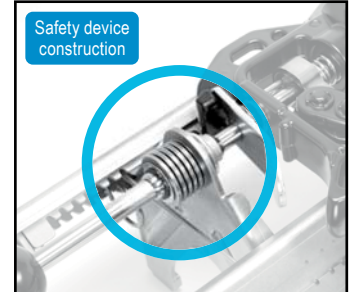

### Safe

If excessive force occurs during connection, the safety device prevents damage to the body. When the safety device is activated, the connection of the CUPLA is disabled.

### Specifications

Model	CJ-1
Body material	Stainless steel (SUS430), Aluminum alloy
Applicable CUPLA	See list on the right
Connection under residue pressure	Not possible
Working temperature	Normal temperature
Storage Temperature Range	-20°C to +60°C
Mass	1.85 kg
Accessories	4 mm Hexagon wrench, Operation procedure tag, Cable tie

Prior to use, confirm the CUPLA to be connected and adjust it according to the model and size. (See instructions for the adjusting procedures provided with the product)

### List of Applicable Models

Applicable models	Size (Thread)			
	Rc 1	Rc 1 1/4	Rc 1 1/2	Rc 2
SP CUPLA Type A	8SP-A	10SP-A	12SP-A	16SP-A
ZEROSPILL CUPLA	ZEL-8SP	-	-	-
HSP CUPLA	8HSP	10HSP	12HSP	16HSP
210 CUPLA	210-8SP	-	-	-
HSU CUPLA	HSU-8SP	-	-	-
S210 CUPLA	S210-8SP	-	-	-
280 CUPLA	280-8SP	-	-	-
350 CUPLA	350-8SP	350-10SP	350-12SP	-
FLAT FACE CUPLA F35	F35-8SP	-	-	-
FLAT FACE CUPLA FF	FF-8SP	-	-	-
SEMICON CUPLA SP Type	8SP-304	-	-	-
SEMICON CUPLA SCS Type	SCS-8SP	-	-	-
SEMICON CUPLA SCY Type	SCY-8SP	-	-	-
SEMICON CUPLA SCT Type	SCT-8SP	-	-	-
SEMICON CUPLA SCAL Type	SCAL-8SP	-	SCAL-12SP	-

### Models and Dimensions

#### Model: CJ-1

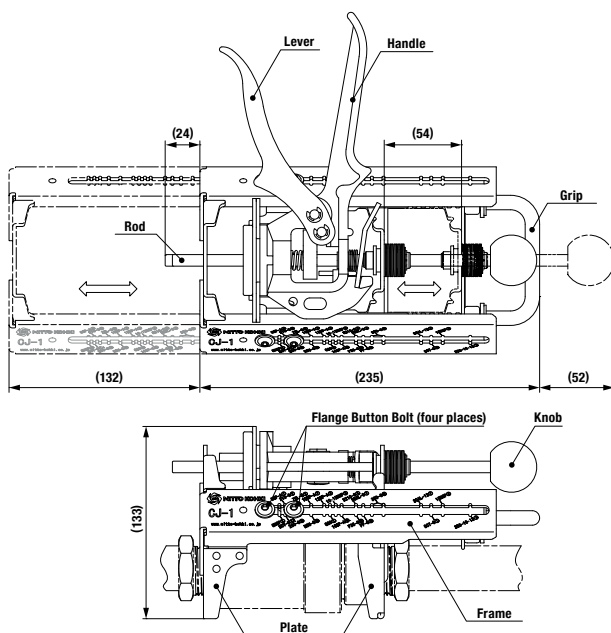

(Note) When the Handle is perpendicular to the body, it may interfere with the CUPLA and will not be able to be used. In this case, tilt the handle to a convenient angle for use.

### Connection of large CUPLA with Lever operation

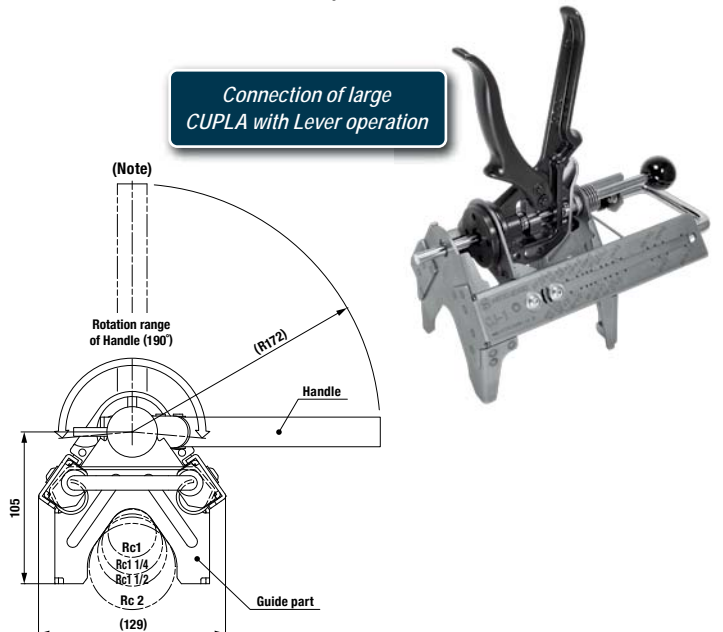

\* To prevent injuries, it is recommended to wear gloves during use.

(mm)



# Seal Material Selection Table for Reference

For seal parts in the CUPLA (the important parts that prevent leaking to the outside), it is important to select the most appropriate seal material to suit the property and temperature of the fluid. It is so important that wrong selection may not only completely malfunction the CUPLA but also cause an unexpected accident.

When the fluid in question is not listed in "Seal Material Selection Table (For reference)," the seal material that you select should be tested under actual environment. Even if the fluid is stated in the following list, the test could be required in some cases.

	Fluids	Seal Material							
		Nitrile rubber	Hydrogenated nitrile rubber	Ethylene-propylene rubber	Fluoro rubber	Perfluoro-elastomer	Silicone rubber	Chloroprene rubber	
2	2,2-Dimethyl-butane	○	○	×	○	○	×	△	
	2,3-Dimethyl-butane	○	○	×	○	○	×	△	
	2,4-Dimethyl-pentane	○	○	×	○	○	×	×	
	2-Methyl-pentane	○	○	×	○	○	×	×	
3	3-Methyl-pentane	○	○	×	○	○	×	×	
A	Acetaldehyde	△	△	○	×	△	○	△	
	Acetic acid	○	○	○	△	○	△	○	
	Acetic anhydride	△	×	○	×	○	○	○	
	Acetone	×	×	○	×	○	×	×	
	Acetonitrile	×		×	△	○	×	×	
	Acetophenone	×	×	○	×	○	×	×	
	Acetyl chloride	×	×	×	○	○	×	×	
	Acetylacetone	×	×	○	×	○	×	×	
	Acetylene	○	○	○	○	○	○	○	
	Air (50°C)	○	○	○	○	○	○	○	
	Aluminium bromide	○	○	○	○	○	○	○	
	Aluminium chloride	○	○	○	○	○	○	○	
	Aluminium nitrate	○	○	○	○	○	○	○	
	Aluminium sulfate	○	○	○	○	○	○	○	
	Amine mixture	×	×	○	×	×	○	○	
	Ammonia (anhydrous)	○	○	○	×	○	○	○	
	Ammonia (Liquid) (65°C)	△			×	○		△	
	Ammonia (Liquid) (Cool)	△		○	×	○	○	○	
	Ammonia gas (Low temperature)	○	○	○	×	○	○	○	
	Ammonium carbonate	×	×	○	○	○	×	○	
	Ammonium chloride	○	○	○	○	○	×	○	
	Ammonium hydroxide	×	×	○	×	×	○	△	
	Ammonium magnesium sulfate	×		×	×		×	×	
	Ammonium nitrate (65°C)	○	○	○			○	○	
	Ammonium phosphate (65°C)	○		○	×	○	○	○	
	Ammonium sulfate	○	○	○	×	○	○	○	
	Ammonium sulfite	△	△	○	△	○	○	○	
	Ammonium thiosulfate	△	△	○	△	○	○	○	
	Amyl acetate	×	×	△	×	○	×	×	
	Amyl alcohol	○	○	○	○	○	×	○	
	Aniline	×	×	○	△	○	×	×	
	Animal oil (Lard)	○	○	○	○	○	○	○	
	Arsenic trichloride	△		×	×	○	×	×	
	Asphalt	○	○	×	○	○	×	×	
	B	Barium chloride	○	○	○	○	○	○	○
		Barium hydroxide	○	○	○	○	○	○	○
		Barium nitrate	△	△	○	△	○	○	○
		Barium sulfate (65°C)	○		○	○	○	○	○
		Barium sulfide	○	○	○	○	○	○	○
		Beer	○	○	○	○	○	○	○
		Benzaldehyde	×	×	○	×	○	○	×
		Benzene	×	×	×	○	○	×	×
		Benzyl alcohol	×	×	○	○	○	△	○
		Benzyl chloride	×	×	×	○	○	×	×
		Brake oil	△	△	○	×	○	△	○
		Bromine	×	×	×	○	○	×	×
		Bromine water	×	×	×	○	○	×	×

	Fluids	Seal Material							
		Nitrile rubber	Hydrogenated nitrile rubber	Ethylene-propylene rubber	Fluoro rubber	Perfluoro-elastomer	Silicone rubber	Chloroprene rubber	
B	Butadiene	×	×	×	○	○	×	×	
	Butane	○	○	×	○	○	×	△	
	Butane (liquid)	○		×	○		×	○	
	Butanol (Butyl alcohol)	○	○	○	○	○	○	○	
	Butter and butter oil	○	○	○	○	○	○	×	
	Butyl acetate	×	×	○	×	○	×	×	
	Butyl stearate	○	○	×	○	○	×	×	
	Butylaldehyde	×	×	○	×	○	×	×	
	Butylene	○	○	×	○	○	×	△	
	C	Cadmium cyanide	△	△	○	△	○	○	○
		Calcium acetate	○	○	○	×	○	×	○
		Calcium acetate (65°C)	○		○	×	○	×	○
		Calcium carbide					○		
Calcium carbonate		○	○	○	○	○	○	○	
Calcium hydroxide		○	○	○	○	○	○	○	
Calcium nitrate (65°C)		○		○	○	○	○	○	
Calcium perchlorate		×		×	×		×	×	
Calcium sulfate		△	△	○	△	○	○	○	
Calcium sulfate (65°C)		×		○	△	○	○	○	
Calcium sulfite		○	○	○	○	○	○	○	
Carbitol		○	○	○	○	○	○	○	
Carbon dioxide gas (65°C)		○		○	○		○	○	
Carbon disulfide		×	×	×	○	○	×	×	
Carbon monoxide (65°C)		○	○	○	○	○	○	○	
Carbon tetrachloride		○	○	×	○	○	×	×	
Castor oil		○	○	○	○	○	○	○	
Chlorine (liquid)		×		×	×	○	×	×	
Chlorine gas		○	○	×	○	○	×	×	
Chlorine water		△	△	○	○	○	×	×	
Chloroacetone		×	×	○	×	○	×	×	
Chlorobenzene		×	×	×	○	○	×	×	
Chloroform		×	×	×	○	○	×	×	
Chlorophenol		×	×	×	○	○	×	×	
Chromium hydroxide						○			
Coconut oil		○	○	△	○	○	○	×	
Cod liver oil		○		○	○	○	○	○	
Coffee		○		×	×		×	×	
Copper chloride		○	○	○	○	○	○	○	
Copper cyanide		○	○	○	○	○	○	○	
Copper sulfate		○	○	○	○	○	○	○	
Corn oil		○	○	△	○	○	○	△	
Cotton seed oil		○	○	△	○	○	○	△	
Cresol (50°C)		×	×	×	○	○	×	×	
Crude oil		○	○	×	○	○	×	×	
Cyclohexane		○	○	×	○	○	×	×	
Cyclohexanol		○	○	×	○	○	×	×	
D	Developer	○	○	○	○	○	○	○	
	Diacetone alcohol	×	×	○	×	○	×	○	
	Dibenzyl ether	×	×	○	×	○	×	×	
	Dichlorophenol	○	○	×	○	○	×	×	
	Diesel oil	○	○	×	○	○	×	×	
	Diethanolamine	△	△	○	△	○	○	○	

# Seal Material Selection Table for Reference

## How to read the selection tables

- ⊙ Practically no harm, and can be used (Excellent)
- Some harm may be inevitable but can be used under restrictions (Good)
- △ Should be avoided if at all possible (Not recommended)
- × Should not be used (Unsuitable)

**Note:** When selecting the seal material, please consider the following suggestions carefully:

1. If there is no comment in the column of the fluid name, the condition of the fluid is under saturation at room temperature.
2. Please check with us for applications at a high fluid temperature or with different fluid concentrations.
3. For applications related to foods, please order separately specifying the detailed applications.

Note: Contact us when the space is blank.

	Fluids	Seal Material						
		Nitrile rubber	Hydrogenated nitrile rubber	Ethylene-propylene rubber	Fluoro rubber	Perfluoro-elastomer	Silicone rubber	Chloroprene rubber
<b>D</b>	Diethylene glycol	⊙	⊙	⊙	⊙	⊙	○	○
<b>E</b>	Ethanol (Ethyl alcohol)	△	△	⊙	△	⊙	○	○
	Ethyl acetate	×		○	×		○	×
	Ethyl benzene	×	×	×	⊙	⊙	×	×
	Ethyl cellulose	○	○	○	×	⊙	○	○
	Ethyl chloride	⊙	⊙	△	⊙	⊙	×	×
	Ethylene glycol	⊙	⊙	⊙	⊙	⊙	⊙	⊙
	Ethylene trichloride	×	×	△	⊙	⊙	×	×
	<b>F</b>	Ferric sulfate	⊙	⊙	⊙	⊙	⊙	
	Fish oil	○	○	×	⊙	⊙	⊙	×
	Fluorine (Gas)	×		×	×	○	×	×
	Formic aldehyde	△	△	○	×	⊙	○	△
	Freon 11	○	×	×	○	○	×	×
	Freon 12	⊙	○	△	△	○	×	⊙
	Freon 22	×	×	△	×	⊙	×	⊙
	Fuel oil	⊙		×	⊙	⊙	×	○
	Furfural	×	×	○	×	⊙	×	×
<b>G</b>	Gasoline	⊙	⊙	×	⊙	⊙	×	×
	Gelatin	⊙	⊙	⊙	⊙	⊙	⊙	⊙
	Glucose	⊙	⊙	⊙	⊙	⊙	⊙	⊙
	Glycerine (65°C)	⊙	⊙	⊙	⊙	⊙	⊙	⊙
	Grease (Petroleum-based)	⊙	⊙	×	⊙	⊙	×	×
<b>H</b>	Helium	⊙	⊙	⊙	⊙	⊙	⊙	⊙
	Heptane (n-heptane)	⊙	⊙	×	⊙	⊙	×	○
	Hexane (n-hexane)	⊙	⊙	×	⊙	⊙	×	○
	Hexylene glycol	△	△	⊙	△	⊙	○	⊙
	Hydraulic oil (Petroleum-based)	⊙	⊙	×	⊙	⊙	○	×
	Hydraulic oil (Phosphate ester series)	×	×	○	⊙	⊙	△	×
	Hydraulic oil (Synthetically-prepared)	○	○	×	⊙	⊙		×
	Hydraulic oil (Water-glycol series)	⊙	⊙	⊙	○	⊙	○	⊙
	Hydraulic oil (Water-in-oil emulsion series)	⊙	⊙	×	⊙	⊙	△	×
	Hydrobromic acid	×	×	⊙	⊙	⊙	×	×
	Hydrogen	⊙	⊙	⊙	⊙	⊙	△	⊙
	Hydrogen peroxide (30%)	×			⊙	⊙		×
	<b>I</b>	Iron chloride	⊙		⊙	⊙		○
Iron nitrate (65°C)		⊙		⊙	⊙		○	⊙
Iron sulfite (100%)		⊙		×	×		×	×
Isoamyl alcohol		×		×	×		×	×
Isooctane		⊙	⊙	×	⊙	⊙	×	○
Isopropanol		○	○	⊙	⊙	⊙	⊙	○
Isopropyl acetate		×	×	○	×	⊙	×	×
Isopropyl alcohol		○	○	⊙	⊙	⊙	⊙	○
Isopropyl ether		○	○	×	×	⊙	×	×
<b>K</b>		Kerosene	⊙	⊙	×	⊙	⊙	×
<b>L</b>	Lard and lard oil	⊙	⊙	○	⊙	⊙	○	○
	Latex	×		×	×		×	×
	Liquefied petroleum gas (LPG)	⊙	⊙	×	⊙	⊙	△	×
	Liquors (beet)	⊙	⊙	⊙	⊙	⊙	⊙	⊙
	Lubricating oil (SAE 10, 20, 30, 40, 50)	⊙	⊙	×	⊙	⊙	×	×
<b>M</b>	Magnesium chloride	⊙	⊙	⊙	⊙	⊙	⊙	⊙
	Magnesium hydroxide	○	○	⊙	⊙	⊙	×	○
	Magnesium nitrate	⊙		×	×		×	×

	Fluids	Seal Material						
		Nitrile rubber	Hydrogenated nitrile rubber	Ethylene-propylene rubber	Fluoro rubber	Perfluoro-elastomer	Silicone rubber	Chloroprene rubber
<b>M</b>	Magnesium sulfate	⊙			⊙	⊙	○	○
	Maleic anhydride	×	×	○	×	⊙	×	×
	Mercury	⊙	⊙	⊙	⊙	⊙	×	⊙
	Methanol	×	×	⊙	×	⊙	⊙	⊙
	Methyl bromide	○	○	×	⊙	⊙	×	×
	Methyl butyl ketone	×	×	⊙	×	⊙	×	×
	Methyl chloride	×	×	△	⊙	⊙	×	×
	Methyl ethyl ketone (MEK)	×	×	⊙	×	⊙	×	×
	Methyl isobutyl ketone (MIBK)	×	×	△	×	⊙	×	×
	Methyl propyl ketone	×		○	×		×	×
	Methyl salicylate	×	×	○	×	⊙	×	△
	Methylene bromide	×		×	⊙	⊙	×	×
	Methylene chloride	×		×	○	⊙	×	×
	Milk	⊙	⊙	⊙	⊙	⊙	⊙	⊙
	Mineral oil	⊙	⊙	×	⊙	⊙	△	△
	Monobromobenzene	×		×	⊙	⊙	×	×
	Monochlorobenzene	×	×	×	⊙	⊙	×	×
Monoethanolamine (MEA)	×	×	○	×	⊙	○	×	
<b>N</b>	n-amyl alcohol	×		×	×		×	×
	Naphtha	○	○	×	⊙	⊙	×	×
	Naphthalene	×	×	×	⊙	⊙	×	×
	Naphthenic oil	⊙		×	⊙		×	×
	n-butyl alcohol	×		×	×		×	×
	Nickel acetate	○	○	⊙	×	⊙	×	○
	Nickel acetate (65°C)	×		⊙	×		×	×
	Nickel ammonium sulfate	△		⊙	△	⊙	○	⊙
	Nickel chloride	⊙	⊙	⊙	⊙	⊙	⊙	⊙
	Nickel nitrate	△	△	⊙	△	⊙	○	⊙
	Nickel sulfate	⊙	⊙	⊙	⊙	⊙	⊙	○
	Nitrobenzene	×	×	△	○	⊙	×	×
	Nitrogen (gas)	⊙	⊙	⊙	⊙	⊙	⊙	⊙
<b>O</b>	Octyl alcohol	○	○	△	⊙	⊙	○	○
	Oleic acid	△	△	×	○	⊙	×	×
	Olive oil	⊙	⊙	○	⊙	⊙	△	×
	Ortho-dichlorobenzene	×	×	×	⊙	⊙	×	×
	Oxygen (gas)	○	○	⊙	⊙	⊙	⊙	○
	Ozone	×	△	⊙	⊙	⊙	⊙	×
	<b>P</b>	Palm oil	×		×	×		×
Paradichlorobenzene	×	×	×	⊙	⊙	×	×	
Paraffin oil	⊙	⊙	×	⊙	⊙	×	×	
Peanut oil	⊙		△	⊙		⊙	○	
Pentane (n-pentane)	⊙	⊙	×	⊙	⊙	×	⊙	
Phenol	×	×	×	⊙	⊙	×	×	
Phosphorous oxychloride (dry)	○		⊙	⊙		○	○	
Phosphorous oxychloride (wet)	○		⊙	⊙		○	○	
Phosphorus	×		×	×	⊙	×	×	
Pine oil	○	○	×	⊙	⊙	×	×	
Potassium acetate (65°C)	○	○	⊙	×	⊙	×	○	
Potassium aluminium sulfate	△	△	⊙	△	⊙	○	⊙	
Potassium bicarbonate	△	△	⊙	△	⊙	○	⊙	
Potassium bichromate	⊙		⊙	⊙	⊙	⊙	⊙	
Potassium carbonate	△	△	⊙	△	⊙	○	⊙	



# Body Material Selection Table

The selection of appropriate body material for the CUPLA is closely related to its usage application, the type of fluid run through, its concentration (%), the pressure, its working environment, etc. So the material must be carefully considered in order to use the CUPLA efficiently and obtain its full performance. Since there are some body materials that should not be used with certain fluids, please refer to this table when making your selection.

○:Suitable    △:Not suitable under certain conditions    ×:Unsuitable

	Fluids	Brass	Stainless Steel	Steel	Aluminum	Polypropylene	
A	Acetic acid	×	○		×	△	
	Acetic anhydride	×	○		△	○	
	Acetone	○	○	○	○	△	
	Air	○	○	○	○	○	
	Aluminum fluoride	○	×			○	
	Aluminum chloride	×	×		×	○	
	Aluminum sulfate	×	○			○	
	Ammonia	×	○		×	○	
	Ammonium nitrate	×	○			○	
	Ammonium phosphate	△	○		×	○	
	Ammonium sulfate	△	△		○	○	
	Aniline	×	○		○	△	
	Arsenic acid	△	○		△	○	
	B	Barium chloride	×	×			○
Barium hydroxide		×	○		×	○	
Barium sulfide			○	○		○	
Beer		○	○	△	○	○	
Benzene		×	○	○	○	△	
Benzine		○	○	○	○	△	
Boric acid		△	○		×	○	
Butane		○	○	○		○	
Butyl acetate		○	○	○	○	△	
C		Calcium chloride	○	△		△	○
		Calcium hydroxide	○	○	○	×	○
		Carbon dioxide	○	○	○	○	○
		Carbon disulfide	○	○	○		×
		Carbon tetrachloride	△	○		×	×
	Carbonic acid	○	○	○	○	○	
	Chlorine		×			×	
	Chromic acid	×	×		×	×	
	Citric acid	△	○		△	○	
	Cresol acid	○	○	○	△	○	
	D	Diesel fuel	○	○	○	○	△
Dowtherm			○				
Drinking water		△	○			○	
E	Ethanol	○	○	○	○	○	
	Ether	○	○	○	○	△	
	Ethyl acetate	○	△	△	△	△	
	Ethylene chloride						
	Ethylene glycol	○	○	○	○	○	
F	Fatty acid	△	○			×	
	Ferric chloride	×	×		×	○	
	Ferric sulfate	×	△			○	
	Formaldehyde 40%	△	○		△	○	
	Formic acid	×	○		×	○	
	Freon	○	○	○	○	×	
G	Glycerine	○	○	○	○	○	

	Fluids	Brass	Stainless Steel	Steel	Aluminum	Polypropylene	
H	Hexane	○	○		○	△	
	Hydrobromic acid		×		×	○	
	Hydrochloric acid	×	×	×	×	○	
	Hydrofluoric acid	△	×		×	○	
	Hydrogen	○	○	○	○	○	
	Hydrogen peroxide	×	○			○	
	Hydrogen sulfide	△	△			○	
	I	Industrial water	○	○	△		
	J	Jet fuel		○	△		
L	Lactic acid	×	○		×	○	
	Liquefied petroleum gas (LPG)	○	○	○	○	○	
M	Magnesium chloride	×	×		△	○	
	Mercury	×	○	○		○	
	Methyl alcohol	○	○	○	○	○	
N	Naphtha	○	○	○	○	△	
	Naphthalene	○	○	○	○	○	
	Natural gas	○	○	○	○	○	
	Nickel chloride	×	×			○	
	Nitric acid	×	△		×	△	
	Nitrobenzene	△	○	○		×	
O	Octane						
	Oxygen	○	○	○		○	
P	Paraffin	○	○	○			
	Phenol	△	○			○	
	Phosphoric acid	×	○		×	○	
	Potassium chloride	△	△		×	○	
	Potassium hydroxide	△	○		×	○	
	Pure water	△	○			○	
	R	Refined gasoline	○	○	○	○	○
Refined petroleum		○	○	○	○	○	
S	Salt water	×	△	×	×	○	
	Sodium carbonate	○	○	○	△	○	
	Sodium chloride	△	△	×	×	○	
	Sodium hydroxide (Caustic soda)		△		×	○	
	Sodium nitrate	△	○	○		○	
	Sodium phosphate		△			○	
	Sodium sulfate	○	○	○	○	○	
Sulfuric acid	×	×	×	×	△		
Sulfurous acid	×	△			○		
T	Tannic acid	×	○			○	
W	Wine	○	○		○	○	
Z	Zinc chloride	×	△		△	○	

Notes: 1. Since fluid concentration (%) and conditions of use may affect the performance, detailed study is necessary when choosing materials.

Notes: 2. For the cells that have no symbol marks, please consult us for appropriate body material.



# Unit Conversion Tables

## Length

m	cm	in	ft	yd	km	mile	n-mile
1	$1 \times 10^2$	$3.937 \times 10$	3.281	1.094	1	$6.214 \times 10^{-1}$	$5.400 \times 10^{-1}$
$1 \times 10^{-2}$	1	$3.937 \times 10^{-1}$	$3.281 \times 10^{-2}$	$1.094 \times 10^{-2}$	1.6093	1	$8.690 \times 10^{-1}$
$2.54 \times 10^{-2}$	2.540	1	$8.333 \times 10^{-2}$	$2.778 \times 10^{-2}$	1.852	1.151	1
$3.048 \times 10^{-1}$	$3.048 \times 10$	$1.2 \times 10$	1	$3.333 \times 10^{-1}$			
$9.144 \times 10^{-1}$	$9.144 \times 10$	$3.6 \times 10$	3	1			

## Area

m <sup>2</sup>	in <sup>2</sup>	ft <sup>2</sup>	yd <sup>2</sup>	km <sup>2</sup>	acre	mile <sup>2</sup>	ha
1	$1.550 \times 10^3$	$1.076 \times 10$	1.196	1	$2.471 \times 10^2$	$3.861 \times 10^{-1}$	$1.00 \times 10^2$
$6.452 \times 10^{-4}$	1	$6.944 \times 10^{-3}$	$7.716 \times 10^{-4}$	$4.046 \times 10^{-3}$	1	$1.562 \times 10^{-3}$	$4.047 \times 10^{-1}$
$9.290 \times 10^{-2}$	$1.44 \times 10^2$	1	$1.111 \times 10^{-1}$	2.590	$6.40 \times 10^2$	1	$2.590 \times 10^2$
$8.361 \times 10^{-1}$	$1.296 \times 10^3$	9	1	$1 \times 10^{-2}$	2.471	$3.861 \times 10^{-3}$	1

## Mass (Weight)

kg	gr	oz	lb	t (metric ton)	ltn (long ton)	stn (short ton)
1	$1.5432 \times 10^4$	$3.527 \times 10$	2.205	$1 \times 10^{-3}$	$9.842 \times 10^{-4}$	$1.102 \times 10^{-3}$
$6.480 \times 10^{-5}$	1	$2.286 \times 10^{-3}$	$1.429 \times 10^{-4}$	$6.480 \times 10^{-8}$	$6.378 \times 10^{-8}$	$7.143 \times 10^{-8}$
$2.835 \times 10^{-2}$	$4.375 \times 10^2$	1	$6.25 \times 10^{-2}$	$2.835 \times 10^{-5}$	$2.790 \times 10^{-5}$	$3.125 \times 10^{-5}$
$4.536 \times 10^{-1}$	$7.000 \times 10^3$	$1.6 \times 10$	1	$4.536 \times 10^{-4}$	$4.464 \times 10^{-4}$	$5 \times 10^{-4}$
$1.000 \times 10^3$	$1.543 \times 10^7$	$3.5274 \times 10^4$	$2.205 \times 10^3$	1	$9.842 \times 10^{-1}$	1.102
$1.016 \times 10^3$	$1.568 \times 10^7$	$3.5840 \times 10^4$	$2.240 \times 10^3$	1.016	1	1.12
$9.072 \times 10^2$	$1.4 \times 10^7$	$3.2000 \times 10^4$	$2.000 \times 10^3$	$9.072 \times 10^{-1}$	$8.929 \times 10^{-1}$	1

## Force

N	kgf	lbf	pdl
1	$1.020 \times 10^{-1}$	$2.248 \times 10^{-1}$	7.233
9.807	1	2.205	$7.093 \times 10$
4.448	$4.536 \times 10^{-1}$	1	$3.217 \times 10$
$1.383 \times 10^{-1}$	$1.410 \times 10^{-2}$	$3.108 \times 10^{-2}$	1

## Pressure

MPa	kgf/cm <sup>2</sup>	lbf/in <sup>2</sup> (PSI)	atm	mmHg	inHg	mmH <sub>2</sub> O	ftH <sub>2</sub> O
1	$1.020 \times 10$	$1.450 \times 10^2$	9.869	$7.501 \times 10^3$	$2.953 \times 10^2$	$1.01972 \times 10^5$	$3.346 \times 10^2$
$9.807 \times 10^{-2}$	1	$1.422 \times 10$	$9.678 \times 10^{-1}$	$7.356 \times 10^2$	$2.896 \times 10$	$1.0000 \times 10^4$	$3.281 \times 10$
$6.895 \times 10^{-3}$	$7.031 \times 10^{-2}$	1	$6.805 \times 10^{-2}$	$5.172 \times 10$	2.036	$7.031 \times 10^2$	2.307
$1.013 \times 10^{-1}$	1.033	$1.470 \times 10$	1	$7.60 \times 10^2$	$2.992 \times 10$	$1.0332 \times 10^4$	$3.390 \times 10$
$1.333 \times 10^{-4}$	$1.360 \times 10^{-3}$	$1.934 \times 10^{-2}$	$1.316 \times 10^{-3}$	1	$3.937 \times 10^{-2}$	$1.360 \times 10$	$4.460 \times 10^{-2}$
$3.386 \times 10^{-3}$	$3.453 \times 10^{-2}$	$4.912 \times 10^{-1}$	$3.342 \times 10^{-2}$	$2.54 \times 10$	1	$3.453 \times 10^2$	1.133
$9.806 \times 10^{-6}$	$1 \times 10^{-4}$	$1.422 \times 10^{-3}$	$9.678 \times 10^{-5}$	$7.356 \times 10^{-2}$	$2.896 \times 10^{-3}$	1	$3.281 \times 10^{-3}$
$2.989 \times 10^{-3}$	$3.048 \times 10^{-2}$	$4.335 \times 10^{-1}$	$2.950 \times 10^{-2}$	$2.242 \times 10$	$8.827 \times 10^{-1}$	$3.048 \times 10^2$	1

# CUPLA Inquiry Form

If you are unable to find a CUPLA that you are looking for, or the type that suits your particular requirements in this catalog, please fill in this form and fax it to our distributor in your country or directly to us. We will select the most suitable CUPLA for your applications and contact you directly or through our distributor.

## FAX Sheet

To NITTO KOHKI CO., LTD.

Company Name		Factory / Branch	
Department / Section		Full Name	
Address		TEL	
E-mail		FAX	

## CUPLA Usage Conditions

Application	(Product / Machinery) Name ( )	Quantity to Be Used	( ) pieces
Size	( ) Standard or Code to be conformed with, if any ( )	Location	Indoors • Outdoors
Product Name	HI CUPLA • SUPER CUPLA • MOLD CUPLA • SP CUPLA TYPE A • HSP • 350 • TSP • MINI CUPLA • Others ( )		
Body Material	( )	Seal Material	( )
Surface Treatment	( )	Connection Disconnection Frequency	( ) times / day • ( ) times / month
Valve	Socket ( with • without ) Plug ( with • without )		
Fluid	Air • Water • Oil • Steam (Others: )		
Pressure	Maximum ( ) MPa Normal ( ) MPa Minimum ( ) MPa Impulse ( with • without )		
Maximum Flow	( ) L/min		
Vacuum	( ) kPa		
Temperature	Maximum ( ) °C Normal ( ) °C Minimum ( ) °C		
Type of Thread	1. Unified Thread 2. Male Thread 3. Female Thread 4. Special thread / hose barb Standard or Code to be conformed with, if any ( ) <div style="border: 1px solid black; width: 300px; height: 150px; margin-top: 10px;"></div>		
Other Requirements			

Please do not write in the following section.

Processing	Model		Seal Material		Drawing No.			
	Body Material		Surface Treatment					

Please make your blank copy of this form to fill in.

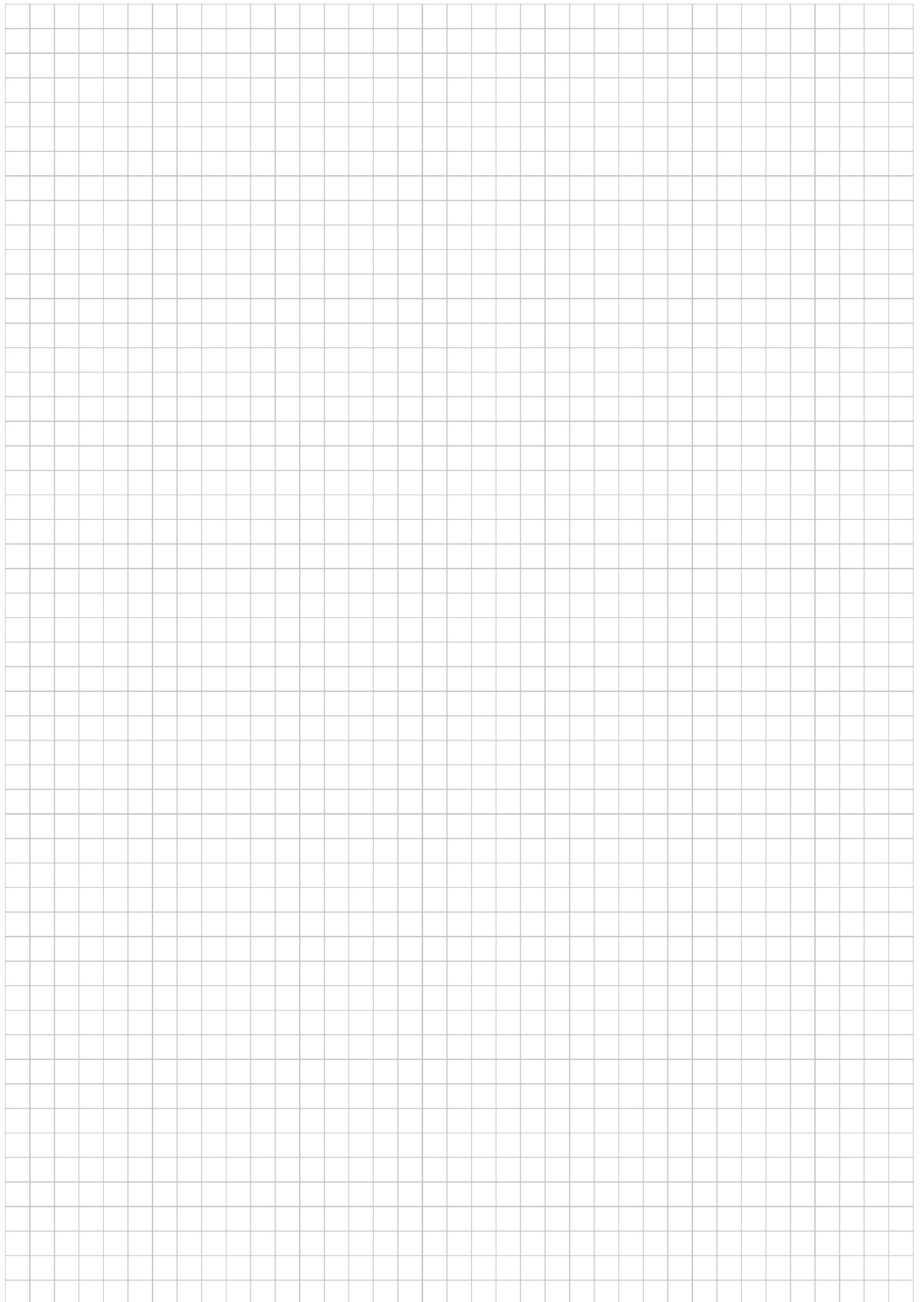

# Taper Pipe Threads

JIS B 0203:1999  
ISO 7-1:1994  
(BS21)

UDC 621.882.082.2 JIS  
Japanese Industrial Standard

This Japanese Industrial Standard specifies taper pipe threads and is applicable to the threads used mainly for pressure-tight joints on the threads for joining pipes, pipe fittings, fluid machinery, etc.

## Attached Table: Basic Profiles, Basic Dimensions and Tolerance

### Basic Profile Applied for Taper External and Taper Internal Threads

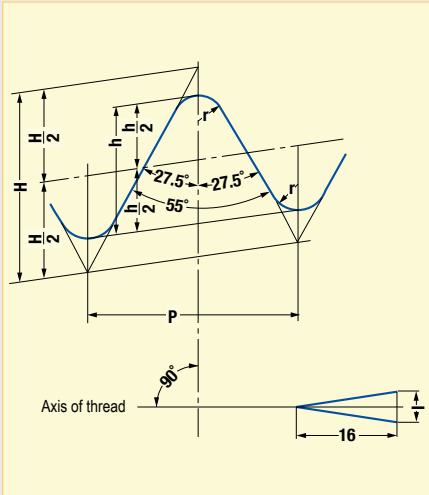

Thick continuous line shows basic profile.

$$P = \frac{25.4}{n}$$

$$H = 0.960237 P$$

$$h = 0.640327 P$$

$$r = 0.137278 P$$

### Basic Profile Applied for Parallel Internal Threads

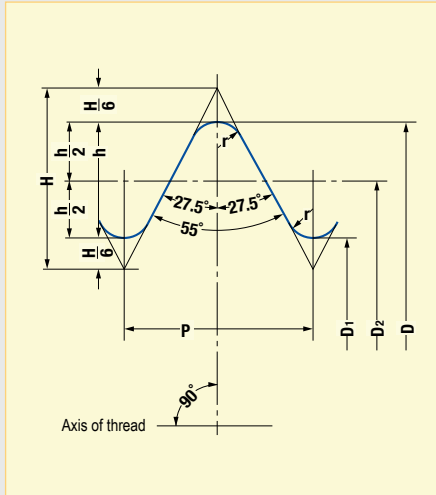

Thick continuous line shows basic profile.

$$P = \frac{25.4}{n}$$

$$H = 0.960491 P$$

$$h = 0.640327 P$$

$$r = 0.137329 P$$

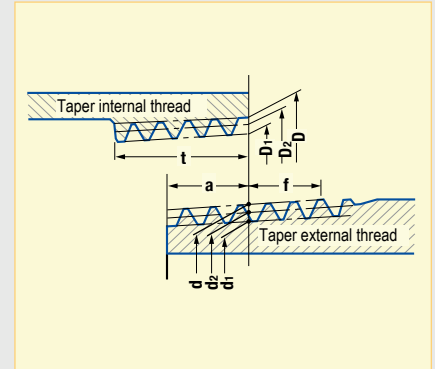

How to symbolize taper pipe threads:

Taper external thread	<b>R 3/8</b>
Taper internal thread	<b>Rc 3/8</b>

Unit: mm

Designation of thread	Thread				Gauge dia.			Position of gauge plane			Tolerance on $D$ , $D_2$ and $D_1$ of parallel internal thread $\pm$	Length of useful thread (min.)				Size of carbon steel pipe for ordinary piping (Given for reference)	
	Number of threads (in 25.4 mm) $n$	Pitch $P$ (Given for reference)	Height of thread $h$	Radius $r$ or $r'$	External thread			External thread	Internal thread	From position of gauge plane toward larger dia. end $f$		When there is incomplete thread part	Internal thread		Outer dia.	Thickness	
					Major dia. $d$	Pitch dia. $d_2$	Minor dia. $d_1$	From pipe end	At pipe end				When there is no incomplete thread part	Taper internal thread			Parallel internal thread
R 1/8	28	0.9071	0.581	0.12	9.728	9.147	8.566	3.97	0.91	1.13	0.071	2.5	6.2	7.4	4.4	10.5	2.0
R 1/4	19	1.3368	0.856	0.18	13.157	12.301	11.445	6.01	1.34	1.67	0.104	3.7	9.4	11.0	6.7	13.8	2.3
R 3/8	19	1.3368	0.856	0.18	16.662	15.806	14.950	6.35	1.34	1.67	0.104	3.7	9.7	11.4	7.0	17.3	2.3
R 1/2	14	1.8143	1.162	0.25	20.955	19.793	18.631	8.16	1.81	2.27	0.142	5.0	12.7	15.0	9.1	21.7	2.8
R 3/4	14	1.8143	1.162	0.25	26.441	25.279	24.117	9.53	1.81	2.27	0.142	5.0	14.1	16.3	10.2	27.2	2.8
R 1	11	2.3091	1.479	0.32	33.249	31.770	30.291	10.39	2.31	2.89	0.181	6.4	16.2	19.1	11.6	34.0	3.2
R 1-1/4	11	2.3091	1.479	0.32	41.910	40.431	38.952	12.70	2.31	2.89	0.181	6.4	18.5	21.4	13.4	42.7	3.5
R 1-1/2	11	2.3091	1.479	0.32	47.803	46.324	44.845	12.70	2.31	2.89	0.181	6.4	18.5	21.4	13.4	48.6	3.5
R 2	11	2.3091	1.479	0.32	59.614	58.135	56.656	15.88	2.31	2.89	0.181	7.5	22.8	25.7	16.9	60.5	3.8
R 2-1/2	11	2.3091	1.479	0.32	75.184	73.705	72.226	17.46	3.46	3.46	0.216	9.2	26.7	30.1	18.6	76.3	4.2
R 3	11	2.3091	1.479	0.32	87.884	86.405	84.926	20.64	3.46	3.46	0.216	9.2	29.8	33.3	21.1	89.1	4.2
R 4	11	2.3091	1.479	0.32	113.030	111.551	110.072	25.40	3.46	3.46	0.216	10.4	35.8	39.3	25.9	114.3	4.5
R 5	11	2.3091	1.479	0.32	138.430	136.951	135.472	28.58	3.46	3.46	0.216	11.5	40.1	43.5	29.3	139.8	4.5
R 6	11	2.3091	1.479	0.32	163.830	162.351	160.872	28.58	3.46	3.46	0.216	11.5	40.1	43.5	29.3	165.2	5.0



# Production Facilities That Assure Our Product Quality

Large scale production facilities in Tochigi Prefecture, Japan and Ayutthaya, Thailand, having the capability of flexible mass production, are in full operation around the clock and constitute a complete high-grade supply system, from the machining of components to the assembly and testing of finished products, that is forever ready and able to respond to our user's reliance.

## Production Facilities Assure Flexible Supply System

### TOCHIGI NITTO KOHKI CO., LTD.

Production of CUPLA, Linear-Motor-Driven Piston Pumps and their Applied Products

Tochigi Nitto Kohki factory is accredited under ISO 14001 & 9001.



In November 1995, the Japan Quality Assurance Foundation, authority for inspection and registration, awarded Tochigi Nitto Kohki "ISO 9001" for quality control and quality assurance in the manufacture of CUPLA products (Quick connect couplings) as well as 1kW or smaller Linear Drive air compressors, vacuum pumps and applied products, and in November 2001 "ISO 14001", also awarded International Standard for environment management systems intended to perform global environment preservation and pollution control.



### NITTO KOHKI INDUSTRY (THAILAND) CO., LTD.

Production of CUPLA, Air Compressors, and Vacuum Pumps

ISO 14001 & 9001



NITTO KOHKI INDUSTRY (THAILAND) CO., LTD. factory is accredited under ISO 14000 and ISO 9001.



# From Development to Production, Management and Marketing of “CUPLA”

Nitto Kohki has introduced the “integrated product assurance system” that can respond promptly to “users’ requirements” by covering the range of development, quality control, production and marketing in order to ensure supply of high-performance high-quality “CUPLA”.

## Nitto Kohki’s Integrated Product Assurance System

### Research and Development

The needs of the time and the latest information are gathered and analyzed, and unique technology is utilized to the challenge for ceaseless development of better CUPLA, CUPLA that suggest new applications.



Headquarters and R & D Laboratory



### Quality Control

The careful selection of materials, painstaking pursuit of machining precision, and strict surveillance processes such as severe endurance tests have earned trust for our CUPLA as a global brand.



### Production

High-grade, rationalized, and integrated production system extends from the machining of parts to the assembly and testing of completed products. Robots that we make ourselves for our own plants and many other state-of-the-art facilities that cannot be seen elsewhere have marvelous capacity for mass production. And with them all, we aim to be an establishment of a flexible supply system.

Tochigi Nitto Kohki factory is accredited under ISO 14001 & 9001.



### Marketing

Meticulous marketing activities include advertising in the general industrial press and specialist papers, national and local exhibitions, training sessions, catalogs, promotion videos, other presentation tools and technical data sheets for new launches, and unique yet dynamic campaigns, etc.





# Nitto Kohki's Laborsaving Products

Nitto Kohki is capturing the needs of users by introducing to the world not only "CUPLA" quick connect couplings, but also next-generation laborsaving devices, including various "machine tools and hand tools", high precision "Delvo" electric screwdrivers, and linear-motor-driven piston "compressors / vacuum pumps".

## Nitto Kohki's Quality Products



## Machines and Tools to Achieve Energy and Labor Savings in Processing Work

Machines and tools are used at various processing sites for such work as cutting, polishing, scaling, drilling and chamfering of steel materials. We have created a product line up of pneumatic, electric and hydraulic machines and tools to match the diversification of processing methods and the conditions of work operations.



## High Precision "delvo" Electric Screwdrivers for Professional Use

NITTO KOHKI Electric Screwdrivers "delvo" are high-quality tools for professional use, with special emphasis on precise control of torque and long life. They apply just the correct amount of torque –with sure, positive control always at your fingertips. They are smooth and shockless in operation, too.



## Compressors, Vacuum Pumps and Their Applied Products

NITTO KOHKI pumps are unique products featuring a linear-motor-driven free piston system. NITTO KOHKI has made available a complete series of air compressors and suction pumps that incorporate this uniquely functional design. These are quite appropriate as air sources or suction power units for various pneumatically operated equipment and apparatus in advanced industries.

## Safety Precautions

The safety precautions provide instructions for the safe use of NITTO KOHKI coupling "CUPLA" to avoid the potential danger of bodily harm or damage to surrounding property. The safety precautions are categorized under the headings **Danger, Warning and Caution**, in accordance with the degree of potential hazard to the body or surrounding property, if CUPLA is used incorrectly. They are all important notes for safety and must be followed as well as in accordance with International standards #1 and other local safety regulations #2.

#1: ISO 4413, Hydraulic Fluid Power – General rules relating to systems    ISO 4414, Pneumatic Fluid Power – General rules relating to systems  
#2: Industrial Health & Safety law (for example)



**DANGER**

Indicates an imminently hazardous situation which, if not avoided, will result in death or serious injury.



**DANGER**

Stop using the product immediately if there is any anticipated danger of operation or reduced safety.



**WARNING**

Indicates a potentially hazardous situation which, if not avoided, could result in death or serious injury.



**WARNING**

The enclosed safety precautions are only a guideline. When using CUPLA, you are requested to pay particular attention to possible hazardous situations for the application which are not stated in the safety precautions.



**CAUTION**

Indicates a potentially hazardous situation which, if not avoided, may result in personal injury or property damage.

## Caution When Selecting CUPLA



**DANGER**

- Connection to a coupling of another brand may cause imperfect connection or disconnection, reduced air tightness, impaired pressure resistance or durability, reduced flow rate and potentially result in an unexpected accident and therefore must be avoided. Nitto Kohki cannot accept liability for any accident that may result by mixed use with the coupling of another brand. Please be sure to check for our marks on the right hand side of this page, which are always inscribed on NITTO KOHKI coupling "CUPLA" when you order and purchase.
- Do not use CUPLA under conditions and environments other than specified in the catalog.



**WARNING**

- Please consult us prior to use if CUPLA is required for use on machines, equipment or systems (hereafter referred to as "equipment, systems, etc.") for sustaining or controlling human life or body.
- When CUPLA is used for the purpose of ensuring safety, please consult us beforehand.
- The compatibility of the product with specific equipment, systems, etc. must be determined by the person designing the equipment, systems, etc. or the person who decides its specifications based on necessary analysis and test result. The expected performance and safety assurance of the equipment, systems, etc. will be the responsibility of the person who has determined its compatibility with the product.
- If CUPLA is to be used for the following applications, please consult us:
  - Vehicles, aircraft and associated equipment systems that accommodate people
  - Medical facilities or suction equipment that directly affects human body
  - Equipment that directly comes into contact with and runs food, drugs or medicines, drinking water, atomic energy equipment or equipment that ensures safety.
- Selecting the wrong type of seal material may cause a leak. In making your selection, please check the compatibility of the seal material with the type of fluid and temperature used in the application.
- Please consult us prior to selection or use of CUPLA when they are intended for use with corrosive or flammable gases/liquids and/or in atmospheres of these types of gases and liquids.

### Warranty and Disclaimer

**Our responsibilities for the defects in our products shall be as follows:**

- We shall be responsible for any defects in design, material or workmanship of our products, if it is apparent that such defects are due to reasons solely attributable to us.
- Our responsibilities shall be limited to one of the following, as determined by us:
  - (a) repair of any defective products or parts thereof,
  - (b) replacement of any defective products or parts thereof; or
  - (c) compensation for loss and damages incurred by you, which shall in no case exceed the amount of your purchase price for the defective products.
- We shall in no case be liable for any special, indirect or consequential loss or damages, whether such loss or damages are those arising from work stoppage, impairment of other goods or death or personal injury.

### Performance, Dimensions and Its Limitation

Please note the performance charts and outside dimensions in this catalog do not take into account any tolerances found in mass production. The information is an average or standard value to be a guide for selecting models and to enable technical appraisal by users.

### Beware of Imitations

Recently, similar products which invite misidentification or confusion with NITTO KOHKI coupling "CUPLA" have appeared on the market. Connection with such a similar product to NITTO KOHKI coupling "CUPLA" may cause:

1. Imperfect connection or disconnection
2. Reduced air tightness
3. Impaired pressure resistance or durability
4. Reduced flow rate

and could result in unexpected accidents.

Therefore, connection other than with NITTO KOHKI coupling "CUPLA" must be avoided.

Please be sure to check for our original marks on the right hand side of this page, which are always inscribed on NITTO KOHKI coupling "CUPLA" products, when you order and purchase.

### Note:

**Nitto Kohki cannot accept any liability for any accident that may occur as a result of using couplings of another brand in conjunction with our own.**

### Markings





# Safety Guide

The following precautions must be taken when using CUPLA. Please contact Nitto Kohki or the outlet / supplier where you purchased the product with regard to repair procedures, certification on the specification or applications of the products.



## Precautions Relating to the Use of All CUPLA products

Be sure to read the "Instruction Sheet" that comes with the product or "Caution" on the package before use.

### CUPLA for Low Pressure (Air)

#### ⚠ Caution

- Prior to use, check the compatibility of the seal material and body material against the temperature and the fluid to be used. Selecting the wrong seal material will lead to leakage.
- As to the use of any special paint or solvent, make thoroughly sure of the material compatibility.
- Do not use CUPLA continuously exceeding the rated working pressure. It will cause leakage or damage.
- Only use CUPLA that are within their rated temperature range. Otherwise this can lead to leakage through seal deterioration or damage. It cannot be used continuously at its lowest or highest rated working temperature.
- The durability of CUPLA differs depending on the operating environment and conditions (pressure and temperature etc.). If necessary, conduct performance evaluation test under your actual operating environment and conditions. Also, stress corrosion cracking may occur if used under corrosive environment. Take note of usage conditions.
- The working pressure and working temperature range for hose connection types depends upon the hose to be used. Prior to use, confirm that the temperature and the type of fluid to be used is suitable for the hose.
- When cleaning CUPLA, care must be taken not to use any material that will affect the seal and body materials.
- Apply a fluoropolymer resin sealant tape on male tapered pipe threads to ensure no leak. (Applies to thread type)
- Do not exceed the recommended maximum torque when screwing in to the male or female thread of CUPLA for installation. It will cause damage. (Applies to thread type, Nut type)
- Care must be taken when installing CUPLA not to overtighten or cross thread, this can cause damage and lead to leakage. (Applies to thread type, Nut type, especially body material: stainless steel)
- Do not use anything other than the applicable hose or tube sizes. It will cause leakage. (Applies to hose or tube fitter connection type)
- Insert the barb (tail) fully into a hose or a tube and secure it tightly with a hose clamp or a nut. Incomplete insertion or insufficient clamping will lead to leakage or sliding off of a hose or a tube from the barb (tail). (Applies to hose or tube fitter connection type)
- Never strike CUPLA when inserting barb (tail) into hose or tube. This could cause poor connection. (Applies to hose or tube fitter connection type)
- Do not use damaged (cracked) or deteriorated hoses or tubes. It will lead to leakage or bursting of hoses or tubes. (Applies to hose or tube fitter connection type)
- Cut off the hose or tube at a designated length from the end when reusing it. Failure to do so will lead to leakage or bursting of the hose or tube. See the "Instruction manual" enclosed with the product for the normal length. (Applies to hose or tube fitter connection type)
- Prior to use, always perform a leak test after installing CUPLA.
- After connection, try to pull the socket and plug apart to confirm secure connection. If the connection is incomplete, the socket and plug may disconnect when pressurized.
- Care should be taken when disconnecting CUPLA whilst still pressurized. To prevent injury due to the Plug popping out, CUPLA should be held firmly in one hand and the Plug in the other. If the medium is a gas, an audible bang may be heard on disconnection. We recommend disconnecting this CUPLA in an unpressurized state. (Except for CUPLA with purge function)
- Put a designated dust cap on CUPLA after disconnection when there is a possibility of foreign matter such as dirt sticking to the seal surface.
- Always install a shut-off valve between the pressure source and CUPLA.
- Do not use with any fluid or medium other than what is specified, to do so could cause leakage or damage.
- The use of inline filters is strongly advised and recommended. To prevent damage, the fluid should be clean before reaching CUPLA.
- Always let fluid flow from socket to plug. It will result in reduced flow. (Except for HI CUPLA Two Way Type)
- Do not use CUPLA in areas or environment where dust such as sand or metal powder can get in to CUPLA. It will lead to malfunction or leakage.
- Do not let paint stick to CUPLA. It will cause malfunction or leakage.
- Be careful not to put scratches or dents on CUPLA. Especially, scratches on the sealing parts will cause leakage.
- Do not apply any artificial impact, bend or tension. It will cause leakage or damage.
- Do not drop CUPLA. It will cause leakage or malfunction.
- Connecting CUPLA directly to vibrating or impacting equipment will result in reduced lifetime. The use of a 'Leader' or 'Whip' hose of approx. 30 cm in length between CUPLA and equipment is recommended to help alleviate this.
- Use only as quick connect couplings for fluid pipelines. (It cannot be used as a swivel joint)
- Only use CUPLA in a combination with NITTO KOHKI coupling "CUPLA".
- Do not disassemble CUPLA. It will cause leakage or damage.

### Cautions on Handling CUPLA HOSE

#### ⚠ Caution

- Do not use CUPLA continuously exceeding the rated working pressure. It will cause leakage or damage.
- Only use CUPLA that are within their rated temperature range. Otherwise the hose will get damaged or deteriorate and cause leakage. It cannot be used continuously at its lowest or highest rated working temperature.
- Do not use on systems that have a high water content, such as drain discharge, this can damage the hose.
- The durability of the Hose differs depending on the operating environment and conditions (pressure and temperature etc.). If necessary, conduct performance evaluation test under your actual operating environment and conditions.
- Make sure that there is no twist or bend on the hose before use.
- Do not exceed the maximum extensible length, to do so will damage the hose. See catalogue page for full specification details. (Applies to NK CUPLA COIL HOSE)
- Do not bend the hose less than the minimum-bending radius. It will cause damage to the hose. ( $\phi 6.5 \times \phi 10$  mm minimum-bending radius :40 mm,  $\phi 8.5 \times \phi 12.5$  mm minimum-bending radius : 50 mm : Applies to NK CUPLA HOSE)
- Do not use with any fluid or medium other than what is specified, to do so could damage the hose.
- The use of inline filters is strongly advised and recommended. To prevent damage, the fluid should be clean before reaching CUPLA. The inclusion of foreign matter in the fluid could damage the hose.
- Do not use CUPLA in areas or environment where dust such as sand or metal powder can get in to CUPLA. This may cause damage to the hose.
- Do not use near fire. It will soften or deform the hose and cause damage to the hose.
- Take care not to damage the hose by dragging over rough ground or concrete. It is also important to ensure that the hose does not become kinked or crushed for long periods.
- Do not use for lifting or hoisting, this can damage the hose.
- Store in a shaded, dry and well-ventilated place.
- Cut off the hose at least 3 cm from the end when reusing it. Failure to do so will lead to leakage or bursting of the hose.
- Prior to use, always perform a leak test after installing CUPLA.

### CUPLA for Oxygen / Fuel Gas

#### ⚠ Warning

- Do not use with any fluid or medium other than what is specified, to do so could cause leakage or damage.
- Do not use CUPLA continuously exceeding the rated working pressure. It will cause leakage or damage.
- Replace CUPLA with a new one if backfire occurs. Backfire damages the body and the seal and will lead to leakage or damage.
- Do not use damaged (cracked) or deteriorated hoses. It will lead to leakage or bursting of hoses. (Applies to hose barb type)
- Never let oil adhere to CUPLA when installing a hose. It will cause spontaneous fire.
- Insert the barb (tail) fully into a hose and secure it tightly with a hose clamp or a nut. Incomplete insertion or insufficient clamping will lead to leakage or sliding off of a hose from the barb (tail). (Applies to hose barb type)
- Prior to use, always perform a leak test after installing CUPLA. Always check for leakage on CUPLA before use. If any leakage is found, stop using immediately.
- Cut off the hose at least 3 cm from the end when reusing it. Failure to do so will lead to leakage or bursting of the hose. (Applies to hose barb type)
- Do not use CUPLA near fire or places where gas accumulates. It will lead to fire or explosion.
- Make sure that the valve on the torch is closed before connecting to CUPLA. If connected with valve open, the gas will flow out and could cause a fire or explosion.
- Do not disassemble CUPLA. It will cause leakage or damage.

#### ⚠ Caution

- Only use CUPLA that are within their rated temperature range. Otherwise this can lead to leakage through seal deterioration or damage. It cannot be used continuously at its lowest or highest rated working temperature.
- The durability of CUPLA differs depending on the operating environment and conditions (pressure and temperature etc.). If necessary, conduct performance evaluation test under your actual operating environment and conditions. Also, stress corrosion cracking may occur if used under corrosive environment. Take note of usage conditions.
- Make sure that O-rings and Packing seals are lubricated with our designated lubricant at all times. The O-rings will get damaged and cause leakage. Not using the designated lubricant will lead to spontaneous fire. (Ask us for the designated lubricant)
- Apply a fluoropolymer resin sealant tape on male tapered pipe threads to ensure no leak. (Applies to thread type)
- Do not exceed the recommended maximum torque when screwing in to the male or female thread of CUPLA for installation. It will cause damage. (Except for hose barb type)
- Do not use anything other than the applicable hose sizes. It will cause leakage. (Applies to hose barb type)
- Never strike CUPLA when inserting barb (tail) into hose. This could cause poor connection. (Applies to hose barb type)
- Do not use damaged (cracked) or deteriorated hoses. It will lead to leakage or bursting of hoses. (Applies to hose barb type)
- After connection, try to pull the socket and plug apart to confirm secure connection. If the connection is incomplete, the socket and plug may disconnect when pressurized.
- Care should be taken when disconnecting CUPLA whilst still pressurized. To prevent injury due to the Plug popping out, CUPLA should be held firmly in one hand and the Plug in the other. If the medium is a gas, an audible bang may be heard on disconnection. We recommend disconnecting this CUPLA in an unpressurized state.
- Always install a shut-off valve between the pressure source and the socket.
- The use of inline filters is strongly advised and recommended. To prevent damage, the fluid should be clean before reaching CUPLA.
- Always let fluid flow from socket to plug. It will result in reduced flow.
- Do not use CUPLA in areas or environment where dust such as sand or metal powder can get in to CUPLA. It will lead to malfunction or leakage.
- Do not let paint stick to CUPLA. It will cause malfunction or leakage.
- Be careful not to put scratches or dents on CUPLA. Especially, scratches on the sealing parts will cause leakage.
- Do not apply any artificial impact, bend or tension. It will cause leakage or damage.
- Do not drop CUPLA. It will cause leakage or malfunction.
- Connecting CUPLA directly to vibrating or impacting equipment will result in reduced lifetime.
- Use only as quick connect couplings for fluid pipelines. (It cannot be used as a swivel joint)
- Only use CUPLA in a combination with NITTO KOHKI coupling "CUPLA".
- Store CUPLA in a dry environment. Moisture will cause corrosion and may also freeze in low temperatures, which may cause malfunction of CUPLA or other equipment.



## Precautions Relating to the Use of All CUPLA products

Be sure to read the "Instruction Sheet" that comes with the product or "Caution" on the package before use.

### MOLD CUPLA / FLOW METER / HOT WATER CUPLA

#### ⚠ Warning

- Do not apply pressure to CUPLA socket while it is disconnected. It will cause leakage or damage. (Applies to MOLD CUPLA or HOT WATER CUPLA)
- Do not use CUPLA continuously exceeding the rated working pressure. It will cause leakage or damage.
- The fluid in the piping of the plug side will spill out upon disconnection. When using for hazardous fluids (such as hot fluid), discharge all the fluid inside CUPLA before disconnecting, in order to prevent burns, etc. (Applies to MOLD CUPLA)

#### ⚠ Caution

- Prior to use, check the compatibility of the seal material and body material against the temperature and the fluid to be used. Selecting the wrong seal material will lead to leakage.
- As to the use of any special paint or solvent, make thoroughly sure of the material compatibility.
- Only use CUPLA that are within their rated temperature range. Otherwise this can lead to leakage through seal deterioration or damage. It cannot be used continuously at its lowest or highest rated working temperature.
- Even if used within the rated operating temperature range, prolonged use of the FLOW METER when under pressure and with the temperature in the upper regions will cause leakage. (Especially when the valve is fully open)
- The durability of CUPLA or FLOW METER differs depending on the operating environment and conditions (pressure and temperature etc.). If necessary, conduct performance evaluation test under your actual operating environment and conditions. Also, stress corrosion cracking may occur if used under corrosive environment. Take note of usage conditions.
- The working pressure and working temperature range for hose connection types depends upon the hose to be used. Prior to use, confirm that the temperature and the type of fluid to be used is suitable for the hose. (Applies to MOLD CUPLA)
- Make sure that O-rings and Packing seals are lubricated with grease at all times. If not, the O-rings will get damaged and cause leakage.
- Apply a fluoropolymer resin sealant tape on male tapered pipe threads to ensure no leak. (Applies to MOLD CUPLA thread type or FLOW METER or HOT WATER CUPLA)
- Do not exceed the recommended maximum torque when screwing in to the male or female thread of CUPLA for installation. It will cause damage.
- When installing FLOW METER, in order to protect the spherical surface of the ball valve, install it with the valve in a fully opened state as a rule. (Applies to MOLD CUPLA thread type or FLOW METER or HOT WATER CUPLA)
- When the valve is fully open or closed, there will be a void between valve body and the ball valve which can trap a small amount of fluid under pressure.
- Before taking the body off from the piping, partially open the valve to allow the pressure to discharge. (Applies to FLOW METER)
- Do not use anything other than the applicable hose sizes. It will cause leakage. (Applies to hose barb type)
- Insert the barb (tail) fully into a hose and secure it tightly with a hose clamp. Incomplete insertion or insufficient clamping will lead to leakage or sliding off of a hose from the barb (tail). (Applies to hose barb type)
- Never strike CUPLA when inserting barb (tail) into hose. This could cause poor connection. (Applies to hose barb type)
- Do not use damaged (cracked) or deteriorated hoses. It will lead to leakage or bursting of hoses. (Applies to hose barb type)
- Cut off the hose at least 3 cm from the end when reusing it. Failure to do so will lead to leakage or bursting of the hose. (Applies to hose barb type)
- Prior to use, always perform a leak test after installing CUPLA.
- After connection, try to pull the socket and plug apart to confirm secure connection. If the connection is incomplete, the socket and plug may disconnect when pressurized. (Applies to MOLD CUPLA or HOT WATER CUPLA)
- Do not connect/disconnect with fluid still under dynamic pressure or static residual pressure. It will cause damage to the valve. (Applies to MOLD CUPLA or HOT WATER CUPLA)
- Always install a shut-off valve between the pressure source and CUPLA.
- Do not use with any fluid or medium other than what is specified, to do so could cause leakage or damage.
- Use it in the state that the fluid does not freeze in the case of water. If it freezes, it will cause damage to CUPLA.
- The use of inline filters is strongly advised and recommended. To prevent damage, the fluid should be clean before reaching CUPLA.
- Design and keep the fluid flow speed through CUPLA below 8 m/s. It will cause damage to the packing if used at 8m/s or over.
- When using FLOW METER, operate the ball valve slowly to prevent water hammer from occurring.
- Let fluid flow in the direction of the arrow shown on the FLOW METER. (Applies to FLOW METER)
- The FLOW METER may cause malfunction of the float due to contamination of foreign matter, water scale or air bubbles inside the fluid.
- Do not use CUPLA in areas or environment where dust such as sand or metal powder can get in to CUPLA. It will lead to malfunction or leakage.
- Do not let paint stick to CUPLA. It will cause malfunction or leakage.
- Be careful not to put scratches or dents on CUPLA. Especially, scratches on the sealing parts will cause leakage. (Applies to MOLD CUPLA or HOT WATER CUPLA)
- Do not apply any artificial impact, bend or tension. It will cause leakage or damage.
- Do not drop CUPLA. It will cause leakage or malfunction.
- Connecting CUPLA directly to vibrating or impacting equipment will result in reduced lifetime.
- Use only as quick connect couplings/flow meter for fluid pipelines. (It cannot be used as a swivel joint)
- Only use CUPLA in a combination with NITTO KOHKI coupling "CUPLA". (Applies to MOLD CUPLA or HOT WATER CUPLA)
- Do not disassemble CUPLA. It will cause leakage or damage.
- When storing FLOW METER, ensure that the valve is fully open. If stored with the valve partially open, the packing will deform and cause leakage.

### CUPLA for Low Pressure (Water, Liquid) and for Medium Pressure

#### ⚠ Warning

- Do not apply pressure to CUPLA socket or plug while they are disconnected. It will cause leakage or damage. (Applies to Valve Structures: Two-way shut-off type and One-way shut-off type)
- Do not use CUPLA continuously exceeding the rated working pressure. It will cause leakage or damage.
- The fluid in the piping will spill out upon disconnection. When using for hazardous fluids (such as hot fluid), discharge all the fluid inside CUPLA before disconnecting, in order to prevent burns, etc. (Applies to Valve Structures: Straight through type and One-way shut-off type)

#### ⚠ Caution

- Prior to use, check the compatibility of the seal material and body material against the temperature and the fluid to be used. Selecting the wrong seal material will lead to leakage.
- As to the use of any special paint or solvent, make thoroughly sure of the material compatibility.
- Only use CUPLA that are within their rated temperature range. Otherwise this can lead to leakage through seal deterioration or damage. It cannot be used continuously at its lowest or highest rated working temperature.
- Even if used within the rated operating temperature range, prolonged use of TSP CUPLA Socket with Ball Valve when under pressure and with the temperature in the upper regions will cause leakage. (Especially when the valve is fully open)
- The durability of CUPLA differs depending on the operating environment and conditions (pressure and temperature etc.). If necessary, conduct performance evaluation test under your actual operating environment and conditions. Also, stress corrosion cracking may occur if used under corrosive environment. Take note of usage conditions.
- The working pressure and working temperature range for hose or tube connection types depends upon the hose or tube to be used. Prior to use, confirm that the temperature and of the type of fluid to be used is suitable for the hose or tube.
- When cleaning CUPLA, care must be taken to use any material that will affect the seal and body materials.
- Make sure that O-rings and Packing seals are lubricated with grease at all times. If not, the O-rings will get damaged and cause leakage. (Except CUPLA with end face seal construction)
- Apply a fluoropolymer resin sealant tape on male tapered pipe threads to ensure no leak. (Applies to thread type)
- Do not exceed the recommended maximum torque when screwing in to the male or female thread of CUPLA for installation. It will cause damage.
- When installing TSP CUPLA Socket with Ball Valve, in order to protect the spherical surface of the ball valve, install it with the valve in a fully opened state as a rule. (Applies to thread type, Nut type)
- Care must be taken when installing CUPLA not to overtighten or cross thread, this can cause damage and lead to leakage. (Applies to thread type, Nut type, especially body material: stainless steel)
- When the valve is fully open or closed, there will be a void between valve body and the ball valve which can trap a small amount of fluid under pressure.
- Before taking the body off from the piping, partially open the valve to allow the pressure to discharge. (Applies to TSP CUPLA Socket with Ball Valve)
- Do not use anything other than the applicable hose or tube sizes. It will cause leakage. (Applies to hose or tube fitter connection type)
- Insert the barb (tail) fully into a hose or a tube and secure it tightly with a hose clamp or a nut. Incomplete insertion or insufficient clamping will lead to leakage or sliding off of a hose or a tube from the barb (tail). (Applies to hose or tube fitter connection type)
- Never strike CUPLA when inserting barb (tail) into hose or tube. This could cause poor connection. (Applies to hose or tube fitter connection type)
- Do not use damaged (cracked) or deteriorated hoses or tubes. It will lead to leakage or bursting of hoses or tubes. (Applies to hose or tube fitter connection type)
- Cut off the hose or tube at a designated length from the end when reusing it. Failure to do so will lead to leakage or bursting of the hose or tube. See the "Instruction manual" enclosed with the product for the normal length. (Applies to hose or tube fitter connection type)
- Prior to use, always perform a leak test after installing CUPLA.
- After connection, try to pull the socket and plug apart to confirm secure connection. If the connection is incomplete, the socket and plug may disconnect when pressurized.
- Put a designated dust cap on CUPLA after disconnection when there is a possibility of foreign matter such as dirt sticking to the seal surface.
- Do not connect/disconnect with fluid still under dynamic pressure or static residual pressure. It will cause damage to the valve. (Applies to Valve Structures: Two-way shut-off type and One-way shut-off type)
- Always install a shut-off valve between the pressure source and CUPLA.
- Do not strike the tip of an automatic shut-off valve with a hammer or a similar tool. It will cause leakage or malfunction. (Applies to medium pressure, Valve Structure: Two-way shut-off type) However, if you need to relieve residual pressure, please consult us.
- Do not use with any fluid or medium other than what is specified, to do so could cause leakage or damage.
- Use it in the state that the fluid does not freeze in the case of water. If it freezes, it will cause damage to CUPLA.
- The use of inline filters is strongly advised and recommended. To prevent damage, the fluid should be clean before reaching CUPLA.
- Design and keep the fluid flow speed through CUPLA below 8 m/s. It will cause damage to the valve if used at 8m/s or over. (Applies to Valve Structures: Two-way shut-off type and One-way shut-off type)
- When using TSP CUPLA Socket with Ball Valve, operate the ball valve slowly to prevent water hammer from occurring. Also be careful not to get fingers caught when operating the handle.
- Do not use CUPLA in areas or environment where dust such as sand or metal powder can get in to CUPLA. It will lead to malfunction or leakage.
- Do not let paint stick to CUPLA. It will cause malfunction or leakage.
- Be careful not to put scratches or dents on CUPLA. Especially, scratches on the sealing parts will cause leakage.
- Do not apply any artificial impact, bend or tension. It will cause leakage or damage.
- Do not drop CUPLA. It will cause leakage or malfunction.
- Connecting CUPLA directly to vibrating or impacting equipment will result in reduced lifetime.
- Use only as quick connect couplings for fluid pipelines. (It cannot be used as a swivel joint)
- Only use CUPLA in a combination with NITTO KOHKI coupling "CUPLA". (Except LEVER LOCK CUPLA)
- Do not disassemble CUPLA. It will cause leakage or damage.
- When storing TSP CUPLA Sockets with Ball valve, ensure that the valve is fully open. If stored with the valve partially open, the packing will deform and cause leakage.

# Safety Guide



## Precautions Relating to the Use of All CUPLA products

Be sure to read the "Instruction Sheet" that comes with the product or "Caution" on the package before use.

### CUPLA for High Pressure

#### **Danger**

- Do not apply pressure to CUPLA socket or plug while they are disconnected. It will cause leakage or damage.

#### **Warning**

- Do not use CUPLA continuously exceeding the rated working pressure. Also, do not use 700R CUPLA in an environment where there is impulse pressure. It will cause leakage or damage.
- Do not connect/disconnect with fluid still under dynamic pressure or static residual pressure. It will cause damage to the valve. However, the HSP-PV type can be connected under static residual pressure.
- After connection, try to pull the socket and plug apart to confirm secure connection. If the connection is incomplete, the socket and plug may disconnect when pressurized.
- Only use CUPLA in a combination with NITTO KOHKI coupling "CUPLA". However, 280 CUPLA is interchangeable with couplers complying with ISO7241-1A.
  - When using by connecting 280 CUPLA with other brand's, compare the pressure specifications and use under the lower pressure.
- Do not disassemble CUPLA. It will cause leakage or damage.

#### **Caution**

- Prior to use, check the compatibility of the seal material and body material against the temperature and the fluid to be used. Selecting the wrong seal material will lead to leakage.
  - As to the use of any special paint or solvent, make thoroughly sure of the material compatibility.
- Only use CUPLA that are within their rated temperature range. Otherwise this can lead to leakage through seal deterioration or damage. It cannot be used continuously at its lowest or highest rated working temperature.
- The durability of CUPLA differs depending on the operating environment and conditions (pressure and temperature etc.). If necessary, conduct performance evaluation test under your actual operating environment and conditions.
- Also, stress corrosion cracking may occur if used under corrosive environment. Take note of usage conditions.
- When cleaning CUPLA, care must be taken not to use any material that will affect the seal and body materials.
- Make sure that O-rings and Packing seals are lubricated with grease or oil at all times. If not, the O-rings will get damaged and cause leakage.
- Apply a fluoropolymer resin sealant tape on male tapered pipe threads to ensure no leak.
- Do not exceed the recommended maximum torque when screwing in to the male or female thread of CUPLA for installation. It will cause damage.
- Care must be taken when installing CUPLA not to overtighten or cross thread, this can cause damage and lead to leakage. (Applies to HSU CUPLA, S210 CUPLA)
- Prior to use, always perform a leak test after installing CUPLA.
- Put a designated dust cap on CUPLA after disconnection when there is a possibility of foreign matter such as dirt sticking to the seal surface.
- Always install a shut-off valve between the pressure source and CUPLA.
- Do not strike the tip of an automatic shut-off valve with a hammer or a similar tool. It will cause leakage or malfunction. However, if you need to relieve residual pressure, please consult us.
- Do not use with any fluid or medium other than what is specified, to do so could cause leakage or damage. Do not use 280 CUPLA with water-glycol operating oil. The plating will dissolve.
- Use it in the state that the fluid does not freeze in the case of water. If it freezes, it will cause damage to CUPLA.
- The use of inline filters is strongly advised and recommended. To prevent damage, the fluid should be clean before reaching CUPLA.
- Design and keep the fluid flow speed through CUPLA below 8 m/s. It will cause damage to the valve if used at 8 m/s or over.
- Do not use CUPLA in areas or environment where dust such as sand or metal powder can get in to CUPLA. It will lead to malfunction or leakage.
- Do not let paint stick to CUPLA. It will cause malfunction or leakage.
- Be careful not to put scratches or dents on CUPLA. Scratches on the sealing parts will cause leakage. Especially, be careful about the seating surface of HSP CUPLA with male parallel thread with 30° flare.
- Do not apply any artificial impact, bend or tension. It will cause leakage or damage.
- Do not drop CUPLA. It will cause leakage or malfunction. If a FLAT FACE CUPLA FF plug is dropped, there is a possibility that the valve may open, to re-set, connect the Socket to the Plug and disconnect, the valve will return to its original position.
- Connecting CUPLA directly to vibrating or impacting equipment will result in reduced lifetime.
- Use only as quick connect couplings for fluid pipelines. (It cannot be used as a swivel joint)
- When using O-Ring seals for GP Type or GS Type of HSP CUPLA, use the O-Ring size described on the "Instruction manual" enclosed with the product.
- Due to the metal-touch valve structure, 450B CUPLA and 700R CUPLA will slightly leak when not coupled.
- Contact us when using CUPLA for high pressure gases.

### MULTI CUPLA Series

#### Overall MULTI CUPLA

#### **Caution**

- Prior to use, check the compatibility of the seal material and body material against the temperature and the fluid to be used. Selecting the wrong seal material will lead to leakage.
  - As to the use of any special paint or solvent, make thoroughly sure of the material compatibility.
- Only use CUPLA that are within their rated temperature range. Otherwise this can lead to leakage through seal deterioration or damage. It cannot be used continuously at its lowest or highest rated working temperature.
- The durability of CUPLA differs depending on the operating environment and conditions (pressure and temperature etc.). If necessary, conduct performance evaluation test under your actual operating environment and conditions.
  - Also, stress corrosion cracking may occur if used under corrosive environment. Take note of usage conditions.
- When cleaning CUPLA, care must be taken not to use any material that will affect the seal and body materials.
- Apply a fluoropolymer resin sealant tape on male tapered pipe threads to ensure no leak. (Applies to Snap ring mount Type, MAM Type, MAM-A Type, MAM-B Type)
- Do not exceed the recommended maximum torque when screwing in to the male or female thread of CUPLA for installation. It will cause damage.
- Prior to use, always perform a leak test after installing CUPLA.
- Always install a shut-off valve between the pressure source and CUPLA.
- Do not use with any fluid or medium other than what is specified, to do so could cause leakage or damage.
- The use of inline filters is strongly advised and recommended. To prevent damage, the fluid should be clean before reaching CUPLA.
- Do not use CUPLA in areas or environment where dust such as sand or metal powder can get in to CUPLA. It will lead to malfunction or leakage.
- Do not let paint stick to CUPLA. It will cause malfunction or leakage.
- Be careful not to put scratches or dents on CUPLA. Scratches on the sealing parts will cause leakage.
- Do not apply any artificial impact, bend or tension. It will cause leakage or damage.
- Connecting CUPLA directly to vibrating or impacting equipment will result in reduced lifetime.
- Use only as quick connect couplings for fluid pipelines.
- Only use CUPLA in a combination with NITTO KOHKI coupling "CUPLA".

#### MAM Type

#### **Warning**

- Do not connect/disconnect with fluid still under dynamic pressure or static residual pressure exceeding the maximum working pressure. It will cause damage to CUPLA.
- Do not drop MULTI CUPLA. It will cause deformation of the plate.

#### **Caution**

- Do not use CUPLA continuously exceeding the rated working pressure. It will cause leakage or damage.
- Make sure that O-rings and Packing seals are lubricated with grease or oil at all times. If not, the O-rings will get damaged and cause leakage.
- Do not deform the stop ring when installing CUPLA. If the stop ring is widened, it may come off from its groove and lead to poor connection or damage of CUPLA. Also change the stop ring with a new one when replacing CUPLA.
- Install hoses symmetrically from the locking unit when they are connected to CUPLA in order to distribute the reaction force evenly. Failure to do so will lead to breakage.
- Connect after making sure that the lever is in the "connect" position. It will not connect if it is not in the "connect" position.
- Do not force turning the lever. It will cause breakage.
- Do not disassemble CUPLA. It will cause leakage or damage.

#### MAM-A Type / MAM-B Type

#### **Warning**

- Do not connect or disconnect CUPLA while they are pressurized or residual pressure of more than 0.6 MPa remains. It will cause damage to CUPLA.
- Do not use CUPLA continuously exceeding the rated working pressure. It will cause leakage or damage.
- Do not drop MULTI CUPLA. It will cause deformation of the plate.

#### **Caution**

- Make sure that O-rings and Packing seals are lubricated with grease or oil at all times. If not, the O-rings will get damaged and cause leakage.
- Install the C type retaining ring by using a pair of snap ring pliers. If the C type retaining rings are expanded too much, it will come off from its groove and lead to poor connection or breakage. Also change the retaining ring with a new one when replacing CUPLA.
- Install hoses symmetrically from the locking unit when they are connected to CUPLA in order to distribute the reaction force evenly. Failure to do so will lead to breakage.
- Connect after making sure that the lever is in the "connect" position. It will not connect if it is not in the "connect" position.
- Do not force turning the lever. It will cause breakage.
- Do not strike the tip of an automatic shut-off valve with a hammer or a similar tool. It will cause leakage or malfunction.
- Use it in the state that the fluid does not freeze in the case of water. If it freezes, it will cause damage to CUPLA.
- Design and keep the fluid flow speed through CUPLA below 8 m/s. It will cause damage to the valve if used at 8 m/s or over.
- Do not disassemble CUPLA. It will cause leakage or damage.



## Precautions Relating to the Use of All CUPLA products

Be sure to read the "Instruction Sheet" that comes with the product or "Caution" on the package before use.

### MULTI CUPLA Series

#### MAS Type / MAT Type

##### Warning

- Do not apply pressure to CUPLA socket or plug while they are disconnected. It will cause leakage or damage.
- Do not use CUPLA continuously exceeding the rated working pressure. It will cause leakage or damage.

##### Caution

- Make sure that O-rings and Packing seals are lubricated with grease or oil at all times. If not, the O-rings will get damaged and cause leakage.
- Keep the center axis eccentricity of the Socket and Plug within 0.6 mm diameter. Failure to do so will lead to leakage or breakage.
- Install the C type retaining ring by using a pair of snap ring pliers. If the C type retaining rings are expanded too much, it will come off from its groove and lead to poor connection or breakage.
- Also change the retaining ring with a new one when replacing CUPLA. (Applies to MAS Type CUPLA)
- Care must be taken when installing CUPLA not to overtighten or cross thread, this can cause damage and lead to leakage.
- When connecting, connect socket and plug together tightly without a gap. If the gap exceeds 0.5 mm the flow will be reduced.
- For the load required to maintain connection when CUPLA is connected, see the page in this catalog where MAS Type / MAT Type is described. Connection exceeding the maximum acceptable load will cause breakage.
- Connecting below the minimum load required to maintain connection will result in reduced flow.
- Do not connect/disconnect with fluid still under dynamic pressure or static residual pressure. It will cause damage to the valve.
- Do not strike the tip of an automatic shut-off valve with a hammer or a similar tool. It will cause leakage or malfunction.
- Use it in the state that the fluid does not freeze in the case of water. If it freezes, it will cause damage to CUPLA.
- Design and keep the fluid flow speed through CUPLA below 8 m/s. It will cause damage to the valve if used at 8 m/s or over.
- Do not drop CUPLA. It will cause leakage or malfunction.
- Do not disassemble CUPLA. It will cause leakage or damage.

#### MALC-01 Type

##### Caution

- Do not use CUPLA continuously exceeding the rated working pressure. It will cause leakage or damage.
- Keep the center axis eccentricity of the Socket, Plug and/or hole in the plate within 2 mm diameter. Failure to do so will lead to leakage or breakage.
- For the dimensions of end configurations for processing on plates, see the page in this catalog where MALC-01 Type is described.
- Obliquity of socket and plug must be within 0.5 degrees during connection or disconnection. If installed exceeding 0.5 degrees, it will cause leakage or damage.
- When connecting, connect socket and plug together tightly without a gap. However, it can be used even when the gap is 0.5 mm. If the gap exceeds 0.5 mm the flow will be reduced.
- For the load required to maintain connection when CUPLA is connected, see the page in this catalog where MALC-01 Type is described. Connection exceeding the maximum acceptable load will cause breakage.
- Connecting below the minimum load required to maintain connection will result in reduced flow.
- When using water, judge whether CUPLA can be used or not by conducting a performance evaluation test under your actual operating environment and conditions.
- Leakage may occur according to rust or foreign matter in the piping or solidified minerals. Use it in the state that the fluid does not freeze in the case of water. If it freezes, it will cause damage to CUPLA.
- Design and keep the fluid flow speed through CUPLA below 8 m/s. It will cause damage to the valve if used at 8 m/s or over.
- Do not drop CUPLA. It will cause leakage or malfunction.
- Do not disassemble CUPLA. It will cause leakage or damage.

#### MALC-SP Type / MALC-HSP Type

##### Danger

- Do not use uncoupled socket or plug continuously exceeding its rated working pressure. It will cause leakage or damage. (Applies to MALC Type CUPLA)

##### Warning

- Do not use CUPLA continuously exceeding the rated working pressure. It will cause leakage or damage.
- Do not disassemble CUPLA. It will cause leakage or damage.

##### Caution

- Keep the center axis eccentricity of the Socket and Plug within 2 mm diameter. Failure to do so will lead to leakage or breakage.
- Obliquity of socket and plug must be within 0.5 degrees during connection or disconnection. If installed exceeding 0.5 degrees, it will cause leakage or damage.
- Install the C type retaining ring by using a pair of snap ring pliers. If the C type retaining rings are expanded too much, it will come off from its groove and lead to poor connection or breakage.
- Also change the retaining ring with a new one when replacing CUPLA. (Applies to Snap ring mount Type)
- Care must be taken when installing CUPLA not to overtighten or cross thread, this can cause damage and lead to leakage. (Applies to MALC-SP Type CUPLA)
- When connecting, connect socket and plug together tightly without a gap. However, it can be used even when the gap is 0.5 mm. If the gap exceeds 0.5 mm the flow will be reduced.
- For the load required to maintain connection when CUPLA is connected, see the page in this catalog where MALC-SP Type or MALC-HSP Type is described.
- Connection exceeding the maximum acceptable load will cause breakage. Connecting below the minimum load required to maintain connection will result in reduced flow.
- Do not strike the tip of an automatic shut-off valve with a hammer or a similar tool. It will cause leakage or malfunction.
- Use it in the state that the fluid does not freeze in the case of water. If it freezes, it will cause damage to CUPLA.
- Design and keep the fluid flow speed through CUPLA below 8 m/s. It will cause damage to the valve if used at 8 m/s or over.
- Do not drop CUPLA. It will cause leakage or malfunction.

### SEMICON CUPLA Series

##### Warning

- Do not apply pressure to CUPLA socket or plug while they are disconnected. It will cause leakage or damage.
- Prior to use, check the compatibility of the seal material and body material against the temperature and the fluid to be used. Selecting the wrong seal material will lead to leakage. (The "Seal Material Selection Table" and "Body Material Selection Table" described in our product catalog is for reference only.)
- Do not use CUPLA continuously exceeding the rated working pressure. It will cause leakage or damage.
- Only use CUPLA that are within their rated temperature range. Otherwise this can lead to leakage through seal deterioration or damage. It cannot be used continuously at its lowest or highest rated working temperature.
- When using hazardous fluids, always wear protective clothing which are suitable for the fluid being used and will protect the whole body. Any spillage or leakage should be dealt with by an expert in that product.
- Do not connect/disconnect with fluid still under dynamic pressure or static residual pressure. It will cause damage to the valve.
- When using pressure tanks, connect/disconnect as follows:  
 Connection: Connect CUPLA on the nitrogen gas side first, and then reduce the nitrogen gas pressure to ambient pressure. Only after then, connect CUPLA on the liquid side.  
 Disconnection: Reduce the nitrogen gas pressure to ambient pressure, and confirm that the internal pressure has become ambient pressure. Only after then, disconnect CUPLA on the liquid side.
- Do not strike the tip of an automatic shut-off valve with a hammer or a similar tool. It will cause leakage or malfunction. However, if you need to relieve residual pressure, please consult us.

##### Caution

- The durability of CUPLA differs depending on the operating environment and conditions (pressure and temperature etc.). If necessary, conduct performance evaluation test under your actual operating environment and conditions.
- Also, stress corrosion cracking may occur if used under corrosive environment. Take note of usage conditions. O-rings are consumable items. Replace them periodically.
- If necessary, conduct an elution test and confirm the suitability of the material.
- When cleaning CUPLA, care must be taken not to use any material that will affect the seal and body materials.
- Apply a fluoropolymer resin sealant tape on male tapered pipe threads to ensure no leak.
- Do not exceed the recommended maximum torque when screwing in to the male or female thread of CUPLA for installation. It will cause damage. (Applies to SP Type, SCS Type, SCY Type)
- Care must be taken when installing CUPLA not to overtighten or cross thread, this can cause damage and lead to leakage. (Applies to SP Type, SCS Type, SCY Type)
- When installing SCT Type or SCAL Type CUPLA, firstly apply a fluoropolymer resin sealant tape on the male tapered pipe thread and tighten firmly by hand. Then, additionally tighten with a wrench by turning it 1 3/4 to 2 turns.
- At this time, overtightening will damage the thread and cause leakage, so be careful.
- Do not use anything other than the applicable tube sizes. It will cause leakage.
- Contact us if detail dimensions of the fixing part is required, such as 19/32-18UNS (for SP Type or SCS Type) or application shape for plugs of SCF Type CUPLA.
- Prior to use, always perform a leak test after installing CUPLA.
- For the purpose of reducing the insertion load on connection and to prevent O-ring from damage, apply pure water or a lubricant that is suitable for the operational environment to the Plug tip and sealing surface. (Applies to SP Type, SCS Type)
- After connection, try to pull the socket and plug apart to confirm secure connection. If the connection is incomplete, the socket and plug may disconnect when pressurized.
- For fluoropolymer resin CUPLA, continuous use under dynamic pressure will result in reduced performance. To extend lifetime, it is recommended to be kept unpressurized unless it is necessary.
- Since the bellows of the SCAL Type CUPLA Socket is made of polytetrafluoroethylene (PTFE), a small amount of gas will escape.
- When using for hazardous fluids, discharge all the fluid inside CUPLA with nitrogen gas, etc., before disconnecting. If disconnected without discharging the fluid, a small amount of fluid will spill out.
- Always mount a designated dust cap after disconnection. Any foreign matter adhering to the sealing surface will cause leakage.
- Always install a shut-off valve between the pressure source and CUPLA.
- The use of inline filters is strongly advised and recommended. To prevent damage, the fluid should be clean before reaching CUPLA.
- Design and keep the fluid flow speed through CUPLA below 8 m/s. It will cause damage to the valve if used at 8 m/s or over.
- Do not use CUPLA in areas or environment where dust such as sand or metal powder can get in to CUPLA. It will lead to malfunction or leakage.
- Do not let paint stick to CUPLA. It will cause malfunction or leakage.
- Be careful not to put scratches or dents on CUPLA. Scratches on the sealing parts will cause leakage. Especially, CUPLA made of fluoropolymer resin are deformed easily, so be careful.



# Safety Guide



## Precautions Relating to the Use of All CUPLA products

Be sure to read the "Instruction Sheet" that comes with the product or "Caution" on the package before use.

### SEMICON CUPLA Series

#### ⚠ Caution

- Do not apply any artificial impact, bend or tension. It will cause leakage or damage.
- Do not drop CUPLA. It will cause leakage or malfunction.
- Connecting CUPLA directly to vibrating or impacting equipment will result in reduced lifetime.
- Use only as quick connect couplings for fluid pipelines. (It cannot be used as a swivel joint)
- Do not disassemble CUPLA. It will cause leakage or damage.
- Check CUPLA regularly. Stop using immediately if anything unusual is found on CUPLA.

### CUPLA for Inert Gas

#### ⚠ Warning

- Do not apply pressure to CUPLA socket or plug while they are disconnected. It will cause leakage or damage. (Applies to SP-V CUPLA)
- Do not use CUPLA continuously exceeding the rated working pressure. It will cause leakage or damage.
- The fluid in the piping will spill out upon disconnection. Take extra care when using at places where it is liable to cause anoxia. (Applies to PCV PIPE CUPLA)

#### ⚠ Caution

- Prior to use, check the compatibility of the seal material and body material against the temperature and the fluid to be used. Selecting the wrong seal material will lead to leakage.
- Only use CUPLA that are within their rated temperature range. Otherwise this can lead to leakage through seal deterioration or damage. It cannot be used continuously at its lowest or highest rated working temperature.
- The durability of CUPLA differs depending on the operating environment and conditions (pressure and temperature etc.). If necessary, conduct performance evaluation test under your actual operating environment and conditions. Also, stress corrosion cracking may occur if used under corrosive environment. Take note of usage conditions. For PCV PIPE CUPLA, replace it with a new one after connection/disconnection of 5000 times as an approximate guide.
- When cleaning CUPLA, care must be taken not to use any material that will affect the seal and body materials.
- Apply thread sealants on male tapered pipe threads to ensure no leak.
- Do not exceed the recommended maximum torque when screwing in to the male or female thread of CUPLA for installation. It will cause damage.
- Care must be taken when installing CUPLA not to overtighten or cross thread, this can cause damage and lead to leakage. (Applies to SP-V CUPLA Body material: Stainless steel)
- Prior to use, always perform a leak test after installing CUPLA.
- Make sure that O-rings are lubricated with grease at all times. If not, the O-rings will get damaged and cause leakage. (Applies to SP-V CUPLA seal materials: )
- For the purpose of reducing the insertion load on connection and to prevent O-ring from damage, apply a lubricant that is suitable for the operational environment to the Plug tip and sealing surface. (Applies to SP-V CUPLA Seal material: HNBR)
- Do not use pipe sizes other than the suitable sizes. It will cause leakage. Contact us if required to use Aluminum alloy pipes. (Applies to PCV PIPE CUPLA)
- Chamfer the edge of the copper pipe to be used. If not chamfered, it will damage the packing and cause leakage. Do not use pipes with deformation or burrs. It will lead to leakage or poor connection. (Applies to PCV PIPE CUPLA)
- When connecting copper pipes, push down the lever only after confirming that the end of the copper pipe is pressed against the packing inside CUPLA. At this time, be careful not to get fingers caught. (Applies to PCV PIPE CUPLA)
- After connection, try to pull the socket and plug apart or CUPLA and pipe apart to confirm secure connection. If the connection is incomplete, the socket and plug may disconnect when pressurized.
- Do not disconnect with fluid still under dynamic pressure or static residual pressure. (Applies to PCV PIPE CUPLA)
- Contact us if it is required to connect/disconnect SP-V CUPLA under dynamic pressure or static residual pressure.
- When connected with the copper pipe, do not rotate the pipe. It will damage the packing and cause leakage. (Applies to PCV PIPE CUPLA)
- Put a designated dust cap on CUPLA after disconnection when there is a possibility of foreign matter such as dirt sticking to the seal surface. (Applies to SP-V CUPLA)
- When disconnected, store CUPLA with the lever in the 'Open' position. (Applies to PCV PIPE CUPLA)
- Always install a shut-off valve between the pressure source and CUPLA.
- Do not strike the tip of an automatic shut-off valve with a hammer or a similar tool. It will cause leakage or malfunction. (Applies to SP-V CUPLA) However, if you need to relieve residual pressure, please consult us.
- Do not use with any fluid or medium other than what is specified, to do so could cause leakage or damage.
- The use of inline filters is strongly advised and recommended. To prevent damage, the fluid should be clean before reaching CUPLA.
- Do not use CUPLA in areas or environment where dust such as sand or metal powder can get in to CUPLA. It will lead to malfunction or leakage.
- Do not let paint stick to CUPLA. It will cause malfunction or leakage.
- Be careful not to put scratches or dents on CUPLA. Especially, scratches on the sealing parts will cause leakage.
- Do not apply any artificial impact, bend or tension. It will cause leakage or damage.
- Do not drop CUPLA. It will cause leakage or malfunction.
- Connecting CUPLA directly to vibrating or impacting equipment will result in reduced lifetime.
- Stop using CUPLA if the lever is deformed. (Applies to PCV PIPE CUPLA)
- Ensure that any copper residue or swarf that has adhered to the inside of CUPLA is removed after use. (Applies to PCV PIPE CUPLA)
- Use only as quick connect couplings for fluid pipelines. (It cannot be used as a swivel joint) (Applies to SP-V CUPLA)
- Only use CUPLA in a combination with NITTO KOHKI coupling "CUPLA". (Applies to SP-V CUPLA)
- Do not disassemble CUPLA. It will cause leakage or damage.

### PAINT CUPLA

#### ⚠ Warning

- Make sure that a hose containing a ground wire is connected to a ground. Insufficient grounding will lead to fire or dangerous explosion caused by possible sparks of static electricity.
- Wear appropriate clothes and protective equipment such as safety glasses, face guard and gloves at all times. Otherwise it could be potentially hazardous when paint or solvent splashes on to operators.

#### ⚠ Caution

- This CUPLA is designed for paints diluted by solvents. Do not use this CUPLA for any other applications such as Powder coating, Electrostatic coating or Electrodeposition coating. The seal material will deteriorate and cause leakage.
- As to the use of any special paint or solvent, make thoroughly sure of the material compatibility.
- Do not use CUPLA continuously exceeding the rated working pressure. It will cause leakage or damage.
- Only use CUPLA that are within their rated temperature range. Otherwise this can lead to leakage through seal deterioration or damage. It cannot be used continuously at its lowest or highest rated working temperature.
- The durability of CUPLA differs depending on the operating environment and conditions (pressure and temperature etc.). If necessary, conduct performance evaluation test under your actual operating environment and conditions. Also, stress corrosion cracking may occur if used under corrosive environment. Take note of usage conditions.
- Do not exceed the recommended maximum torque when screwing in to the male or female thread of CUPLA for installation. It will cause damage.
- Prior to use, always perform a leak test after installing CUPLA.
- After connection, try to pull the socket and plug apart to confirm secure connection. If the connection is incomplete, the socket and plug may disconnect when pressurized.
- The fluid in the piping of the plug side will spill out upon disconnection. Be careful so that it will not contact the human body.
- Clean CUPLA each time after use. Otherwise paint will dry out and will cause malfunction, insufficient color mix or poor grounding. When cleaning CUPLA, care must be taken not to use any material that will affect the seal and body materials.
- When cleaning, do not try to open the valve by inserting something except the plug into the socket. It will cause leakage.
- Always install a shut-off valve between the pressure source and CUPLA.
- The use of inline filters is strongly advised and recommended. To prevent damage, the fluid should be clean before reaching CUPLA.
- Always let fluid flow from socket to plug.
- Do not use CUPLA in areas or environment where dust such as sand or metal powder can get in to CUPLA. It will lead to malfunction or leakage.
- Be careful not to put scratches or dents on CUPLA. Especially, scratches on the sealing parts will cause leakage.
- Do not apply any artificial impact, bend or tension. It will cause leakage or damage.
- Do not drop CUPLA. It will cause leakage or malfunction.
- Connecting CUPLA directly to vibrating or impacting equipment will result in reduced lifetime.
- Use only as quick connect couplings for fluid pipelines. (It cannot be used as a swivel joint)
- Only use CUPLA in a combination with NITTO KOHKI coupling "CUPLA".
- Do not disassemble CUPLA. It will cause leakage or damage.

## ⚠ Precautions Relating to the Use of All CUPLA products

Be sure to read the "Instruction Sheet" that comes with the product or "Caution" on the package before use.

### HYGIENIC CUPLA

#### ⚠ Warning

Any residual fluid remaining in the passage will spill out on disconnection. Drain any residual fluid before disconnection to avoid burns or injury to the skin when dangerous fluid such as chemical agent or high temperature fluid is used. If the fluid comes into contact with the skin, stop the disconnecting work and consult a doctor if necessary.

#### ⚠ Caution

Observe the cautions below. If not observed, it could result in burns, injury to the skin, damage to the product or other machinery when dangerous fluid such as chemical agent or high temperature fluid is used. Stop using CUPLA immediately if this happens.

- CUPLA can be easily disassembled for cleaning. CUPLA should be evaluated before use to determine the suitability with regard to sanitation and safety. Especially when using O-rings of other brands than Nitto Kohki, be sure to evaluate the O-ring at your end.
- Prior to use, check the compatibility of the seal material and body material against the temperature and the fluid to be used. Selecting the wrong seal material will lead to leakage.
- Do not use CUPLA continuously under any pressure exceeding the rated working pressure. This may cause leakage or damage.
- Use only within range of its rated temperature. May cause damage or deterioration to the sealing and leak if used otherwise.
- Also, do not use continuously at the lowest or highest working temperature.
- The durability of CUPLA differs depending on the operating environment and conditions (pressure and temperature etc.).
- If necessary, conduct performance evaluation test under your actual operating environment and conditions.
- When assembling, disassembling and washing, do not drop the disassembled parts, or put scratches on the sealing surface. It will cause malfunction or leakage.
- When washing, do not deform the lock plate by applying excessive force. It will cause bad connection.
- When assembling or disassembling, do not put scratches on the O-ring. Also do not attach the O-ring in a twisted state. It will cause leakage.
- When welding to CUPLA, do so with CUPLA in disassembled state. Welding in assembled state will deform the parts or damage the O-ring and cause leakage.
- The outer diameter and thickness of the pipe to be welded to CUPLA must conform to JIS G 3447.
- After welding to CUPLA, please polish the welded part. (Surface roughness Ra  $\leq$  1.0  $\mu$ m recommended for the liquid contact parts. Surface roughness on the weld line should not exceed Ry=16  $\mu$ m.)
- If it is not polished or if the surface roughness becomes rougher than the recommended value, it may potentially cause the spread of bacteria.
- Malfunction caused by welding (directly or otherwise) is not included in the warranty.
- For the ferrule type, please use ferrule couplings conforming to IDF / ISO 2852.
- Prior to use, always perform a leak test after installing CUPLA.
- When a high temperature fluid is applied to CUPLA, be careful in handling CUPLA as it also becomes hot.
- If CUPLA is used in a high temperature atmosphere, the cam handle may not rotate smoothly.
- In such case, please apply water, etc. to the part where the cam handle and the lock plate ASSY is in contact.
- When powder is applied to CUPLA, static electricity may be generated. Please take countermeasure against this if required.
- When CUPLA remains connected for long periods of time, it may become difficult to disassemble.
- In this case, do not forcefully turn the socket and plug to disconnect as this may damage the seal material and cause leakage.
- Do not disconnect with fluid still under dynamic pressure or static residual pressure.
- Do not drop CUPLA. It will cause leakage or malfunction.
- Always install a shut-off valve between the pressure source and CUPLA.
- Do not apply any artificial impact, bend or tension. It will cause leakage or damage.
- Connecting CUPLA directly to vibrating or impacting equipment will result in reduced lifetime.
- Use only as quick connect couplings for fluid pipelines.
- Only use CUPLA in a combination with NITTO KOHKI coupling "CUPLA".
- Check CUPLA regularly. Stop using immediately if anything unusual is found on CUPLA.
- When storing CUPLA, remove the O-ring from the plug. Otherwise, it may become difficult to remove due to adsorption.
- Before using CUPLA, disassemble and clean it in the way that is appropriate to your usage conditions and not affecting the seal material and body material.



#### Seal part (cross section)

Because of the structure of this product, dead space is generated when using.

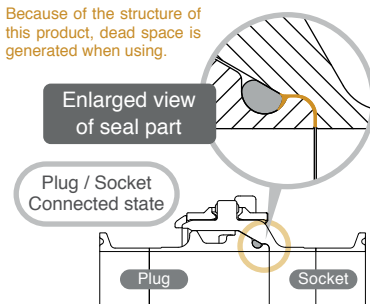

- The O-ring and Lock plate ASSY are consumable items.
- Please replace the Lock plate ASSY at approximately 1,000 times connections / disconnections.
- When the Lock plate ASSY is deformed, replace it with a new one regardless of connection/disconnection times.
- The durability of the O-ring differs depending on the operating environment and conditions (pressure and temperature etc.).

### SEMI-STANDARD CUPLA Series

Contact us separately for detail cautions for the SEMI-STANDARD CUPLA series.

## Maintenance of CUPLA

### O-ring Replacement Procedure

The internal O-ring is a consumable item. If the O-ring in the socket has failure such as wear and tear or deterioration, take the following steps to replace it with a new one. Always use genuine Nitto Kohki O-rings.

#### Accessories for O-ring maintenance

##### Grease for O-ring

5 mL container



##### O-ring replacement Jig

PMJ-1 (Small)

PMJ-2 (Large)



- GRE-M1 (Mineral grease) for NBR and FKM
- GRE-HC1 (Hydrocarbon grease) for NBR and FKM
- GRE-S1 (Silicone grease) for NBR, FKM, and EPDM
- GRE-S2 (Silicone grease) for NBR, FKM, and EPDM (NSF H1, NSF 61 registered product)

#### ⚠ Caution for Storing CUPLA

- Store CUPLA in a place where no dust or foreign matter gets in. If fluid flows while the dust or foreign matter is present inside CUPLA, the dust or foreign matter may go into the equipment connected to CUPLA and may cause malfunction.
- Store CUPLA indoors away from water or moisture.
- Store CUPLA in a shaded, dry and well-ventilated place.
- Do not to drop CUPLA. It will deform or damage CUPLA.
- If CUPLA are stored or not being used for a long period of time, check their appearance, function and performance before use.

CUPLA should be inspected periodically to ensure safe operation and to prevent them from a performance drop or malfunction. If there is a malfunction in CUPLA or wear and tear, please replace it with a new one. If you have any concerns, contact Nitto Kohki or the distributor from whom you purchased your CUPLA.

#### How to Remove the O-ring

- 1 Use an optional O-ring replacement Jig to remove the O-ring. Be careful not to damage the groove of O-ring with the jig. Used O-rings with wear and tear or deterioration can be removed easily with the jig.
- 2 After removing the O-ring, wipe the groove clean with a cloth.

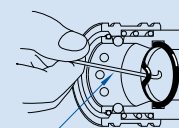

O-ring replacement Jig

#### How to Install a New O-ring

- 1 After making sure that no dust or foreign matter exists in the groove of O-ring, push in part of the O-ring and the remaining part can be easily pressed in with the jig.
- 2 HSP CUPLA has a backup ring. Insert an O-ring in the place as shown in the figure. If CUPLA connection/disconnection is hard and not smooth after the O-ring has been replaced, apply a little grease to the O-ring.

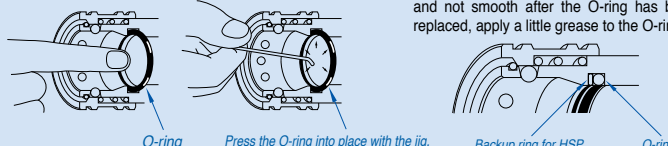



## Quick Connect Couplings

The logo for CUPLA is registered trademark or a trademark of Nitto Kohki Co., Ltd. in Japan, the United States and/or certain other countries.

# NITTO KOHKI CO., LTD.

## Head Office

9-4, Nakaikagami 2-chome, Ohta-ku, Tokyo 146-8555, Japan

Tel : +81-3-3755-1111 Fax : +81-3-3753-8791 E-mail : [overseas@nitto-kohki.co.jp](mailto:overseas@nitto-kohki.co.jp)

**Web** [www.nitto-kohki.co.jp/e](http://www.nitto-kohki.co.jp/e)



ISO 9001  
JQA-2025  
ISO 14001  
JQA-EM4057  
H.Q./R&D Lab

## Overseas Affiliates / Offices

### NITTO KOHKI U.S.A., INC.

46 Chancellor Drive, Roselle, Illinois 60172, U.S.A.

For CUPLA

Tel : +1-630-924-5959 Fax : +1-630-924-1174

For Tool

Tel : +1-630-924-9393 Fax : +1-630-924-0303

For Pump

Tel : +1-630-924-8811 Fax : +1-630-924-0808

[www.nittokohki.com/](http://www.nittokohki.com/)

### NITTO KOHKI CO., LTD. Mexico Representative Office

Torre Corporativo 1 Piso 11 Central Park Armando Birlain Shaffler

#2001 Col Centro Sur, Queretaro, Qro, C.P. 76090, Mexico

Tel : +52-442-290-1234

### NITTO KOHKI EUROPE GMBH

Gottlieb-Daimler-Str. 10, 71144 Steinenbronn, Germany

Tel : +49-7157-989555-0 Fax : +49-7157-989555-40

[www.nitto-kohki.eu/](http://www.nitto-kohki.eu/)

### NITTO KOHKI EUROPE GMBH UK Branch

Unit A5, Langham Park Industrial Estate, Maple Road,  
Castle Donington, Derbyshire DE74 2UT, United Kingdom

Tel : +44-1332-653800 Fax : +44-1332-987273

[www.nitto-kohki.eu/](http://www.nitto-kohki.eu/)

### NITTO KOHKI CO., LTD. Bangkok Representative Office

M&A Business Center, 7th Floor, Unit 7A, Chalanttip Building,

38 Convent Road, Silom, Bangrak, Bangkok 10500, Thailand

Tel : +66-2632-0307 Fax : +66-2632-0308

[www.nittobkk.com/](http://www.nittobkk.com/)

### NITTO KOHKI CO., LTD. India Liaison Office

3rd Floor, Building No.9-A DLF Cyber City, Phase-III,

Gurgaon, Haryana 122002, India

Tel : +91-124-454-5031 Fax : +65-6227-0192

### NITTO KOHKI CO., LTD. Singapore Branch

10 Ubi Crescent #01-62, Ubi Techpark Lobby D, Singapore 408564

Tel : +65-6227-5360 Fax : +65-6227-0192

[www.nitto-kohki.co.jp/e/nksb/index.html](http://www.nitto-kohki.co.jp/e/nksb/index.html)

### NITTO KOHKI AUSTRALIA PTY LTD

77 Brandi Street, Eight Mile Plains, Queensland 4113, Australia

Tel : +61-7-3340-4600 Fax : +61-73340-4640

[www.nitto-australia.com.au/](http://www.nitto-australia.com.au/)

### NITTO KOHKI (SHANGHAI) CO., LTD.

Room1506, Suite C, Orient International Plaza,

No.85 Loushanguan Road, Shanghai 200336, China

Tel : +86-21-6415-3935 Fax : +86-21-6472-6957

[www.nitto-kohki.cn/](http://www.nitto-kohki.cn/)

### NITTO KOHKI (SHANGHAI) CO., LTD. Shenzhen Branch

2005C Shenzhen ICC Tower, Fuhuasanlu 168,

Futian District, Shenzhen, Guangdong 518048, China

Tel : +86-755-8375-2185 Fax : +86-755-8375-2187

[www.nitto-kohki.cn/](http://www.nitto-kohki.cn/)

DISTRIBUTED BY



This catalog is printed using environmentally friendly paper and vegetable oil inks.